

The Air Leakiness of OSB

Measuring air and moisture flow through building materials and assemblies

David W. Boyer & Tom Schneider

PROSOCO Building Envelope Innovations

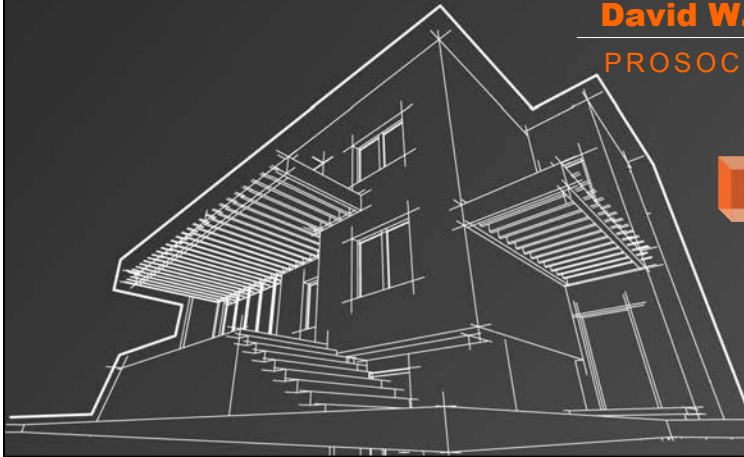





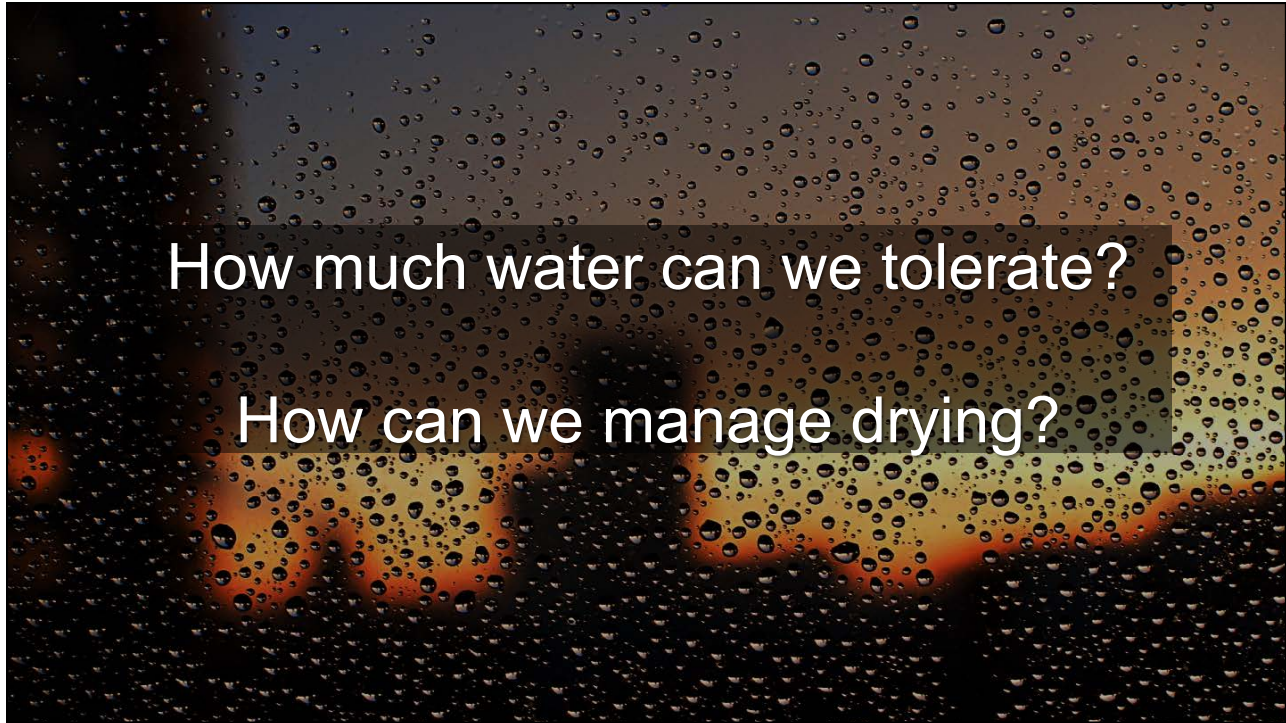

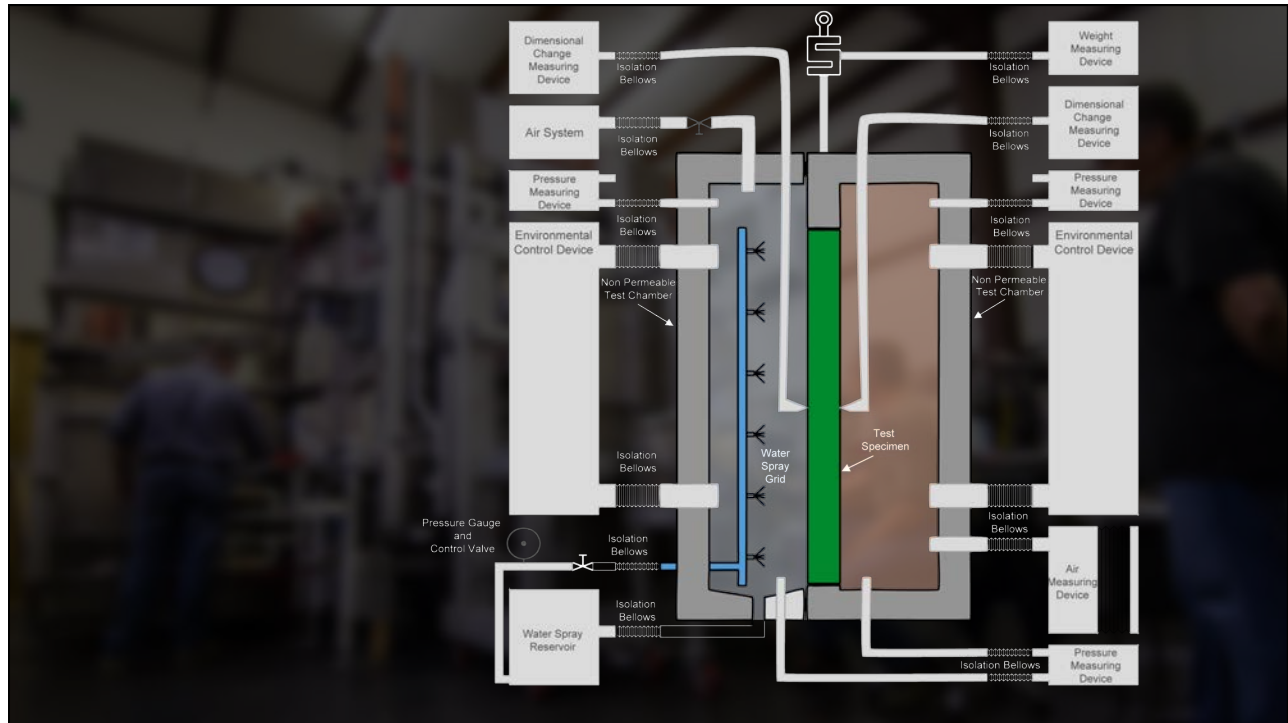

Two welded aluminum pressure bells

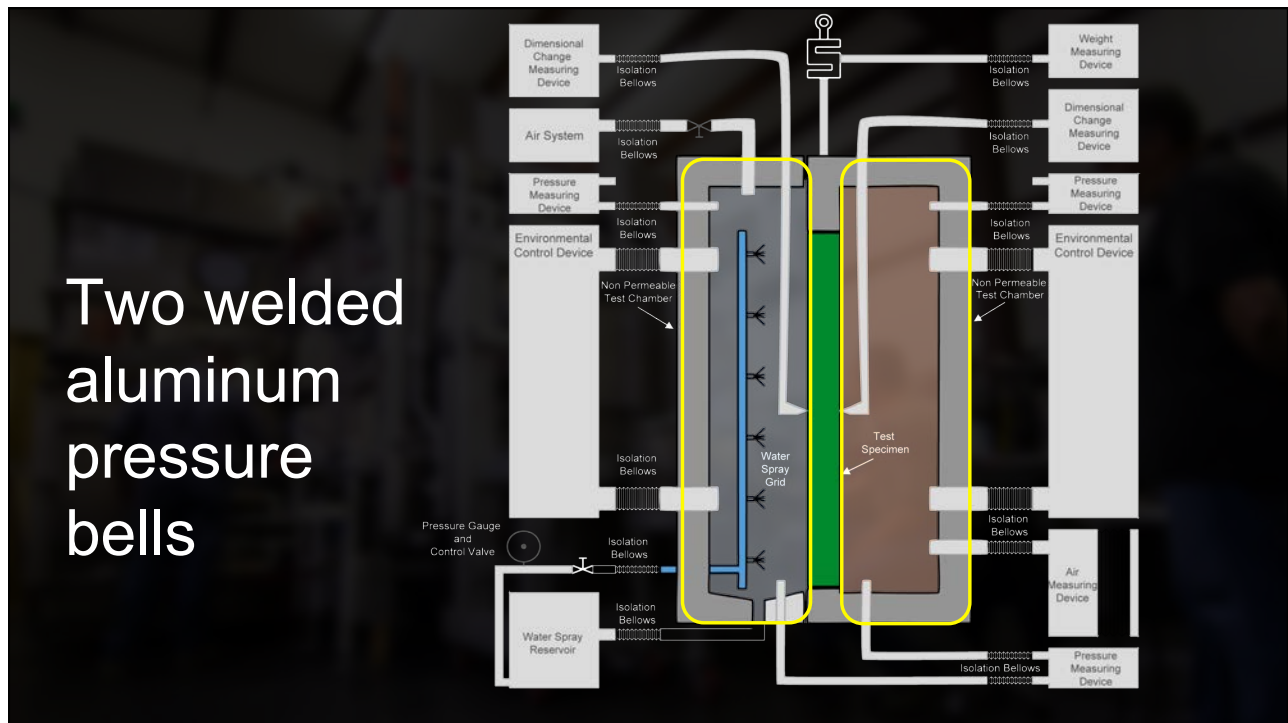

Environmental controls

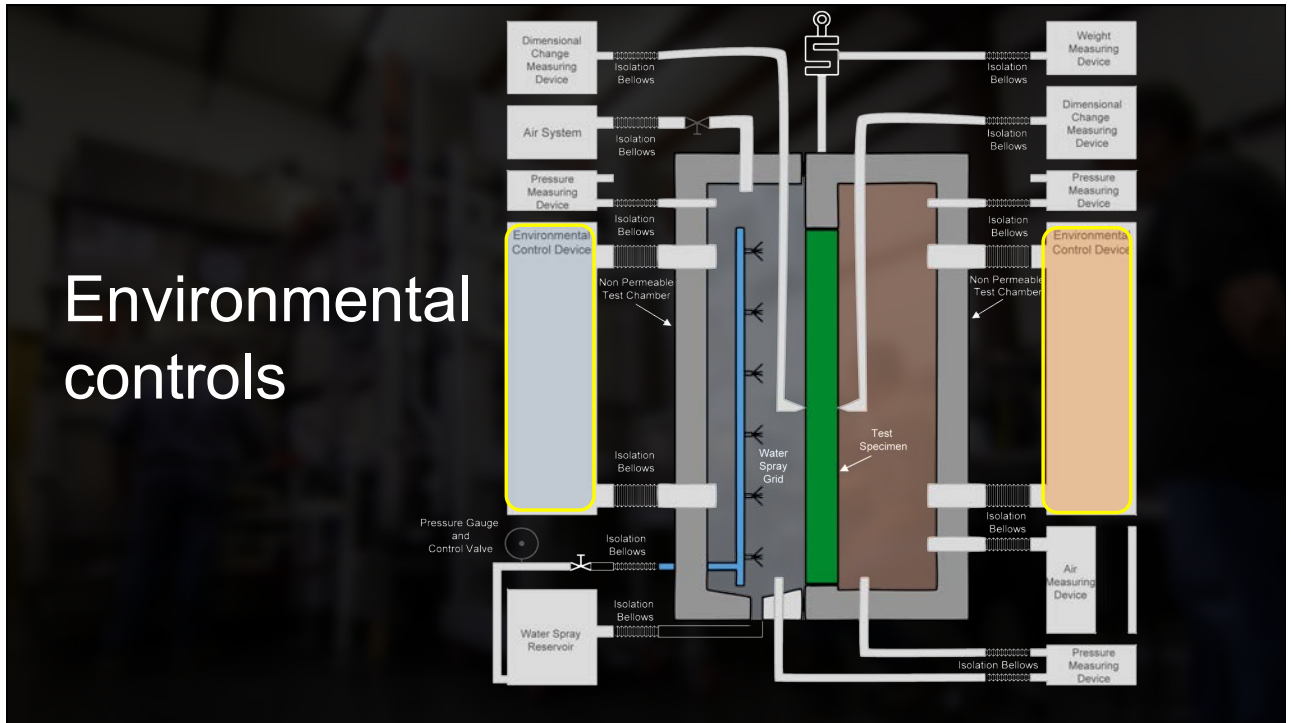

Mock-up access

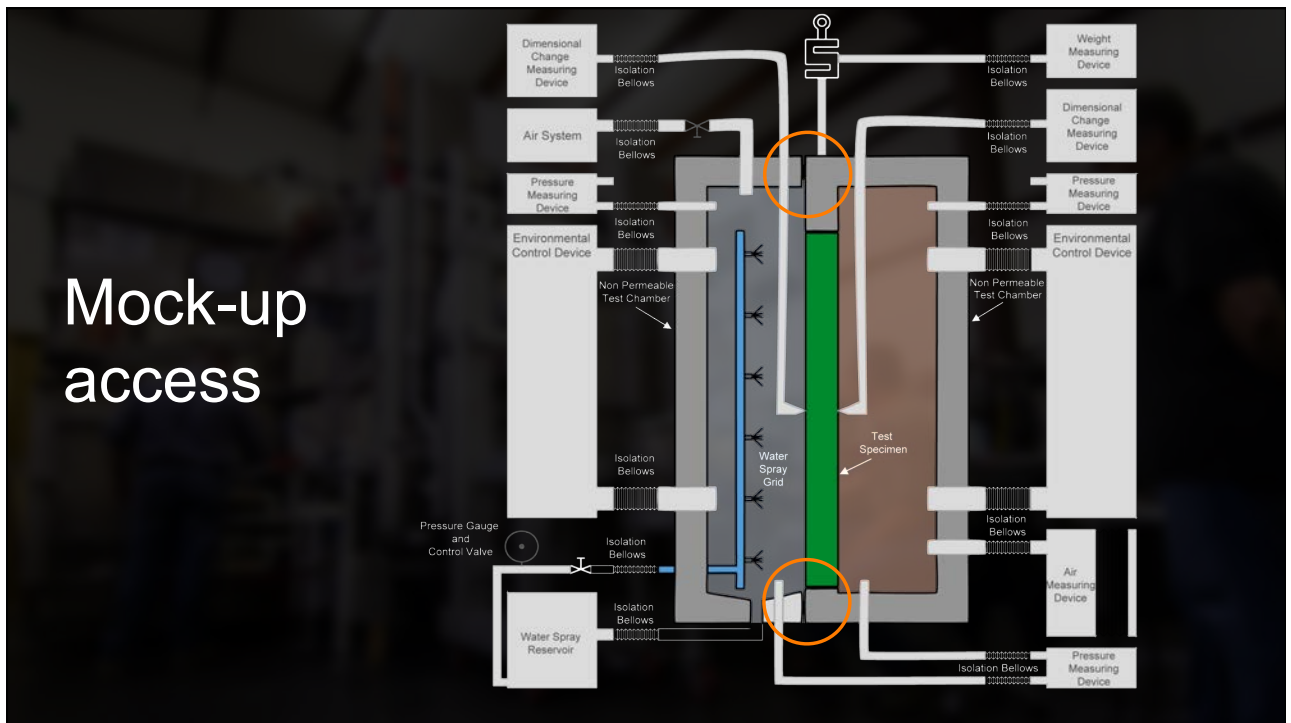

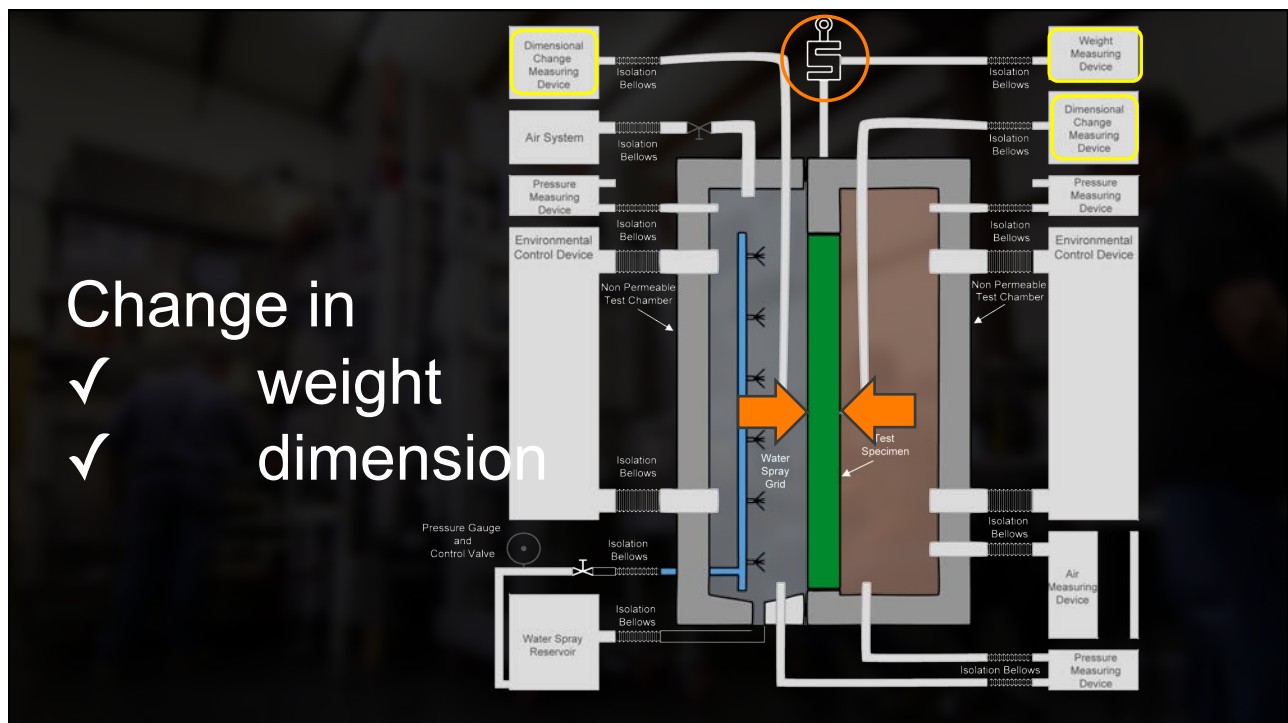
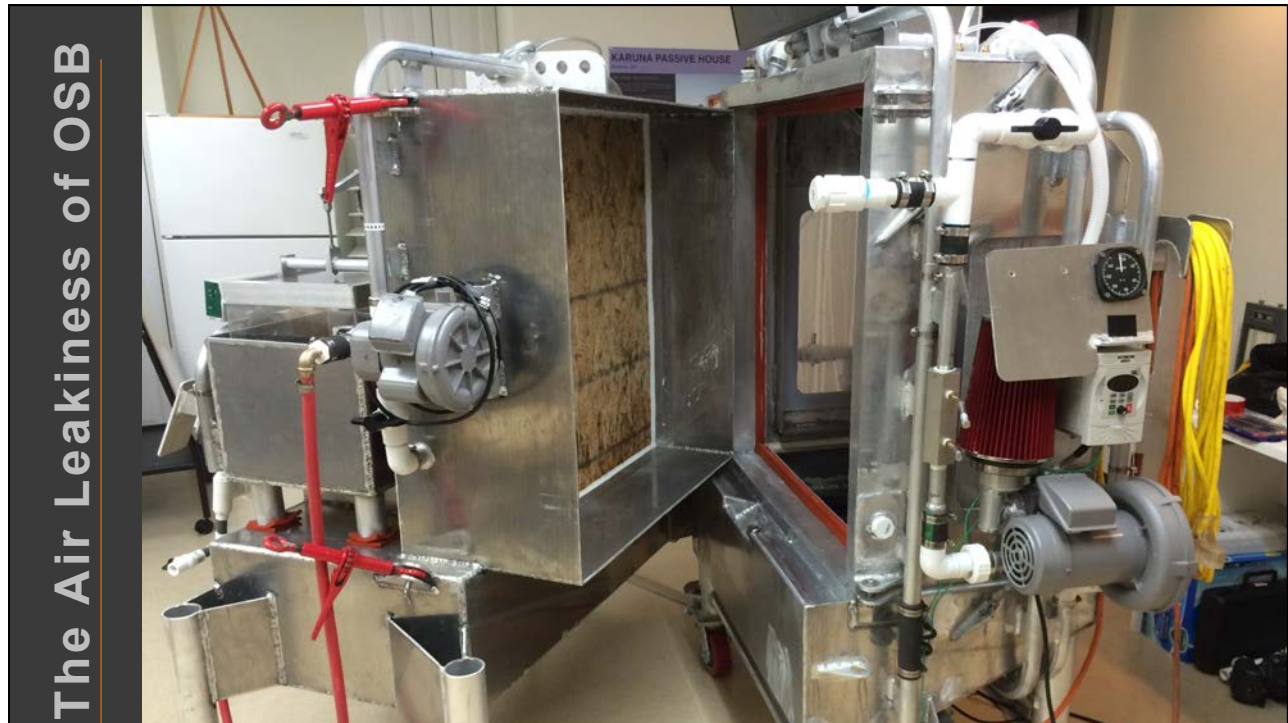

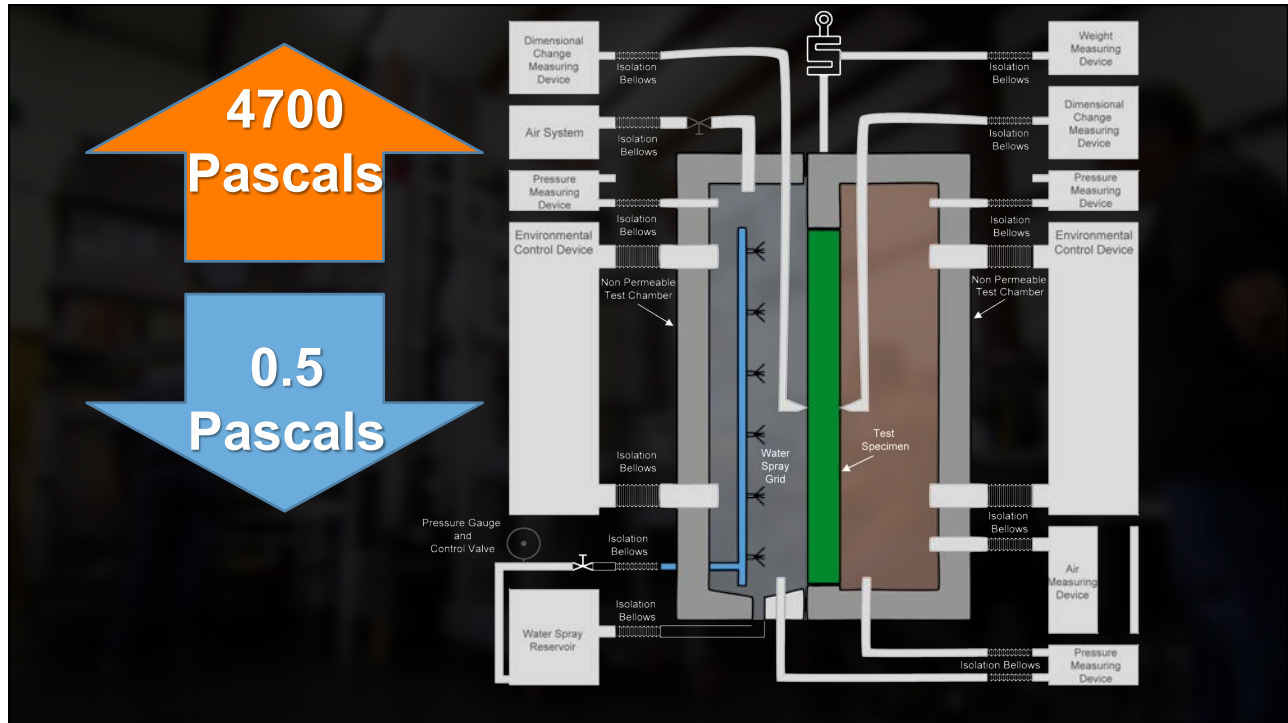

Water Vapor Transmission		Water Vapor Transmission	
g/m ² per 24h air velocity = 1 ft./sec		g/m ² per 24h air velocity = 1 ft./sec	
<i>Perms</i> g/m ² /24hmmHG		<i>Perms</i> g/m ² /24hmmHG	
35.36	3.35	18.34	2.28
ASTM E96 Water Method		ASTM E96 Water Method	
ASTM E96 Dessicant Method		ASTM E96 Dessicant Method	
11.41	1.07	11.44	1.08

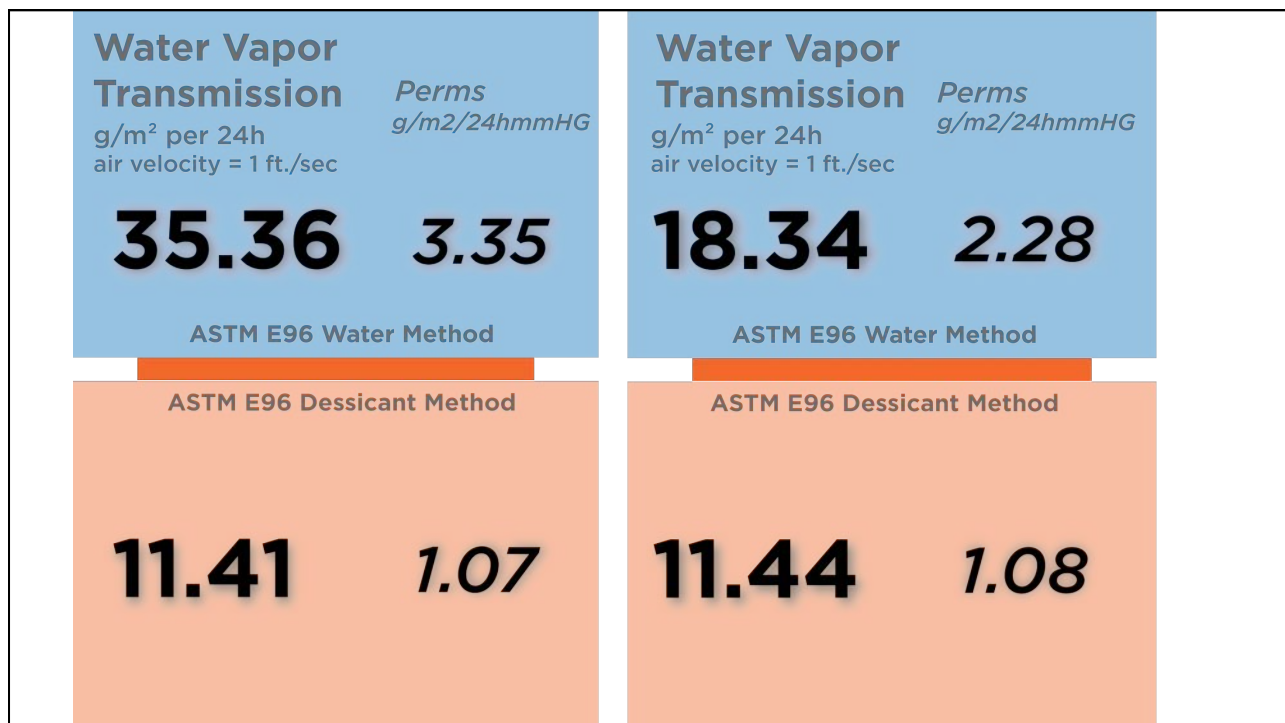
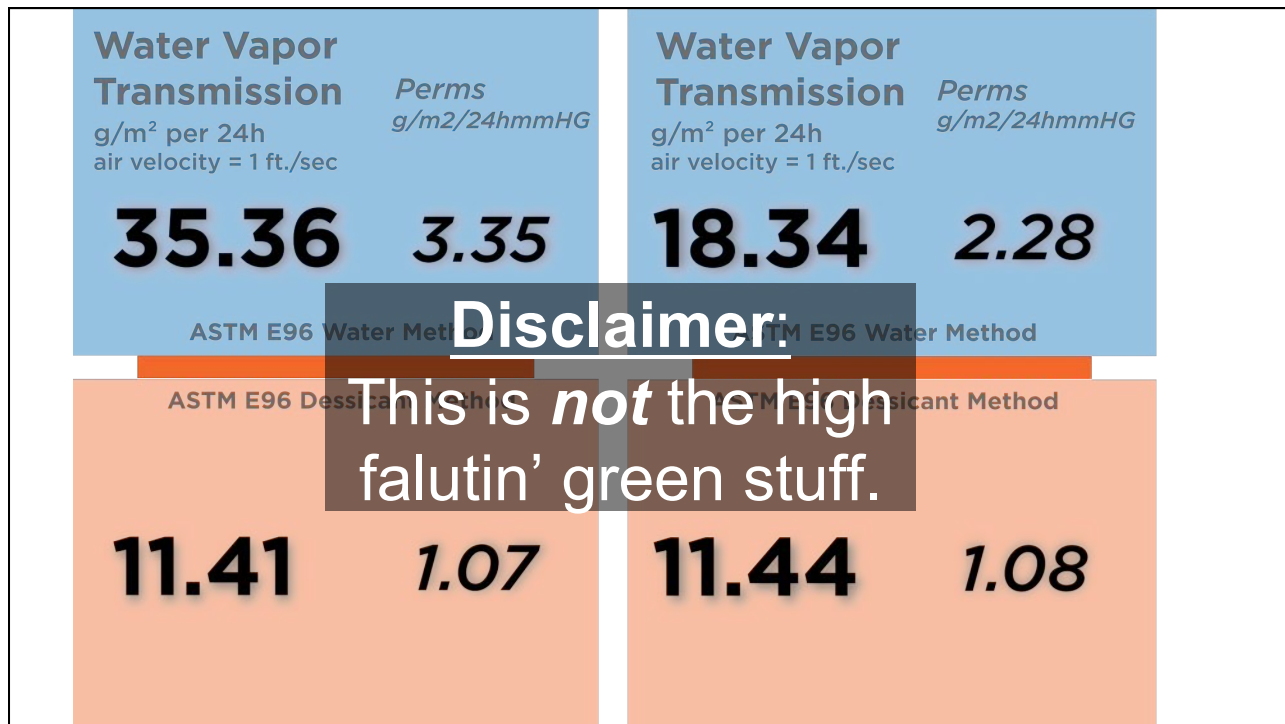

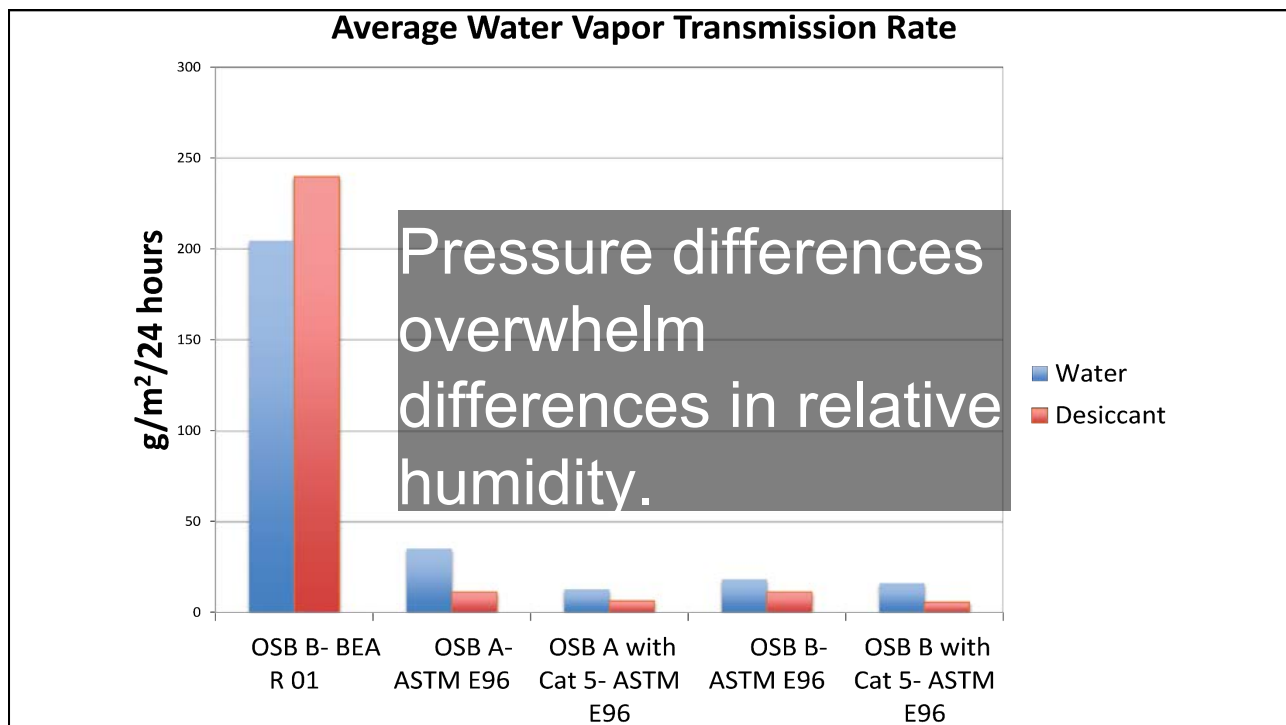
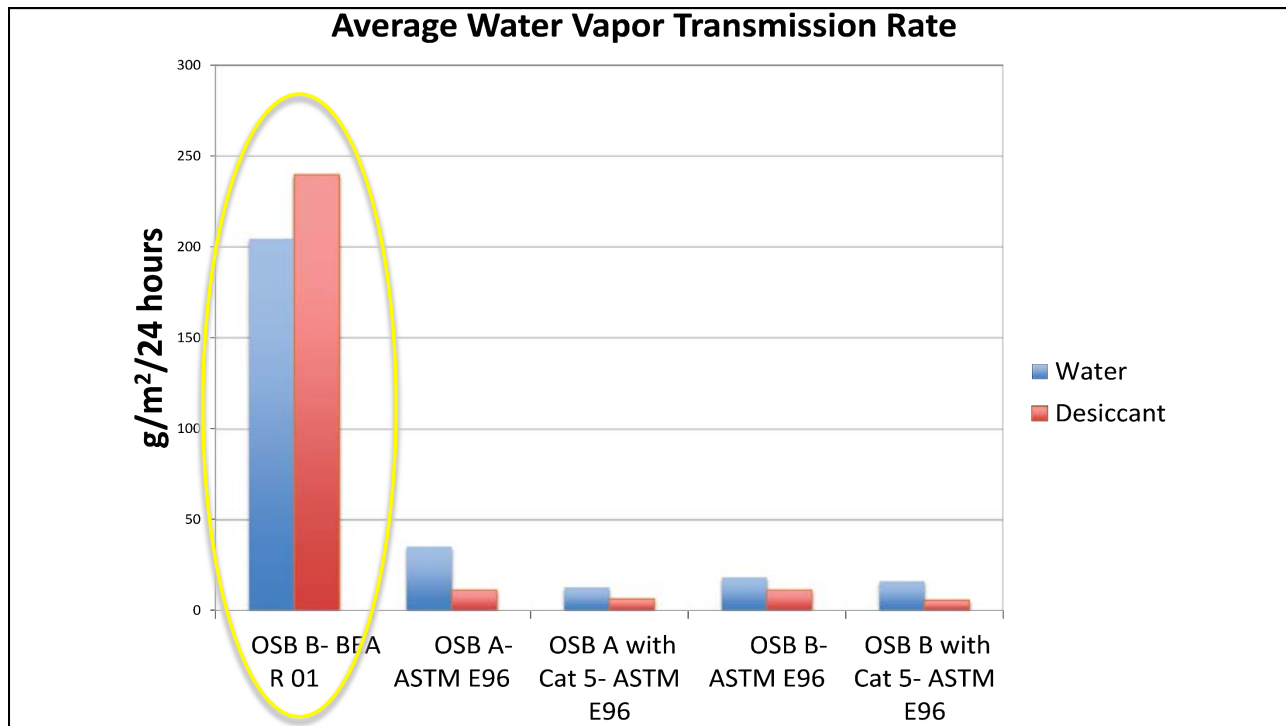

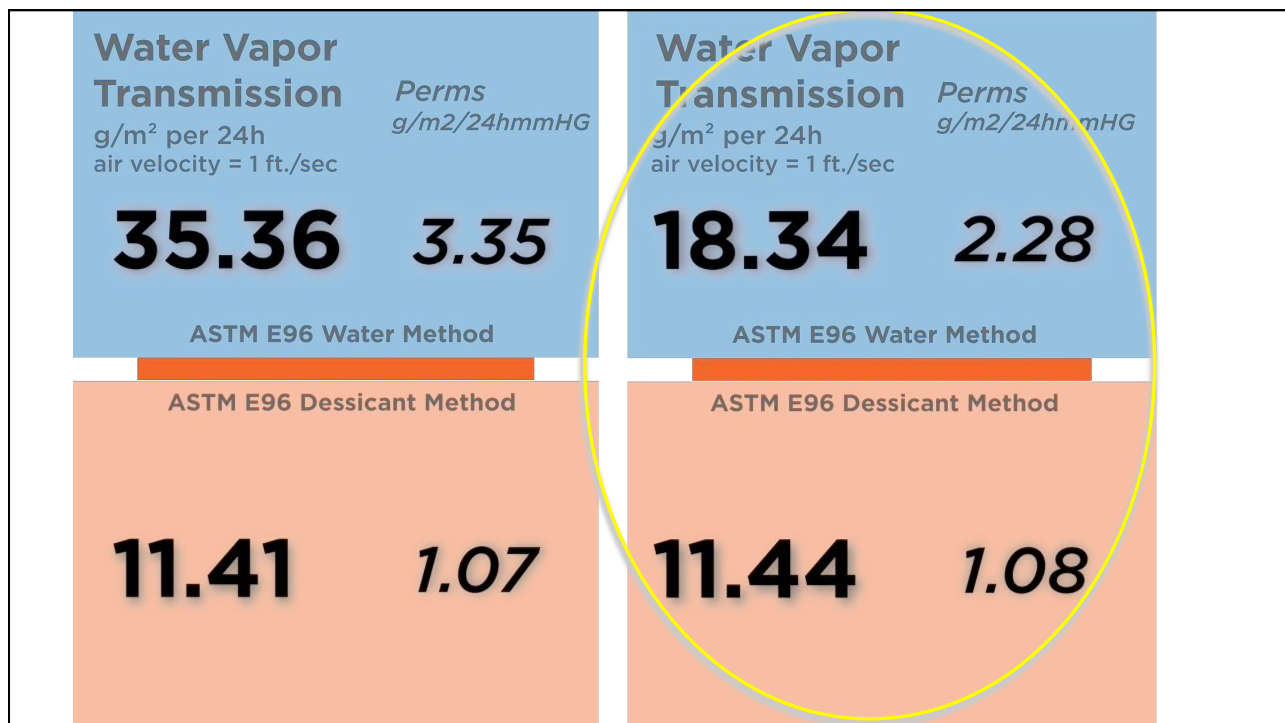
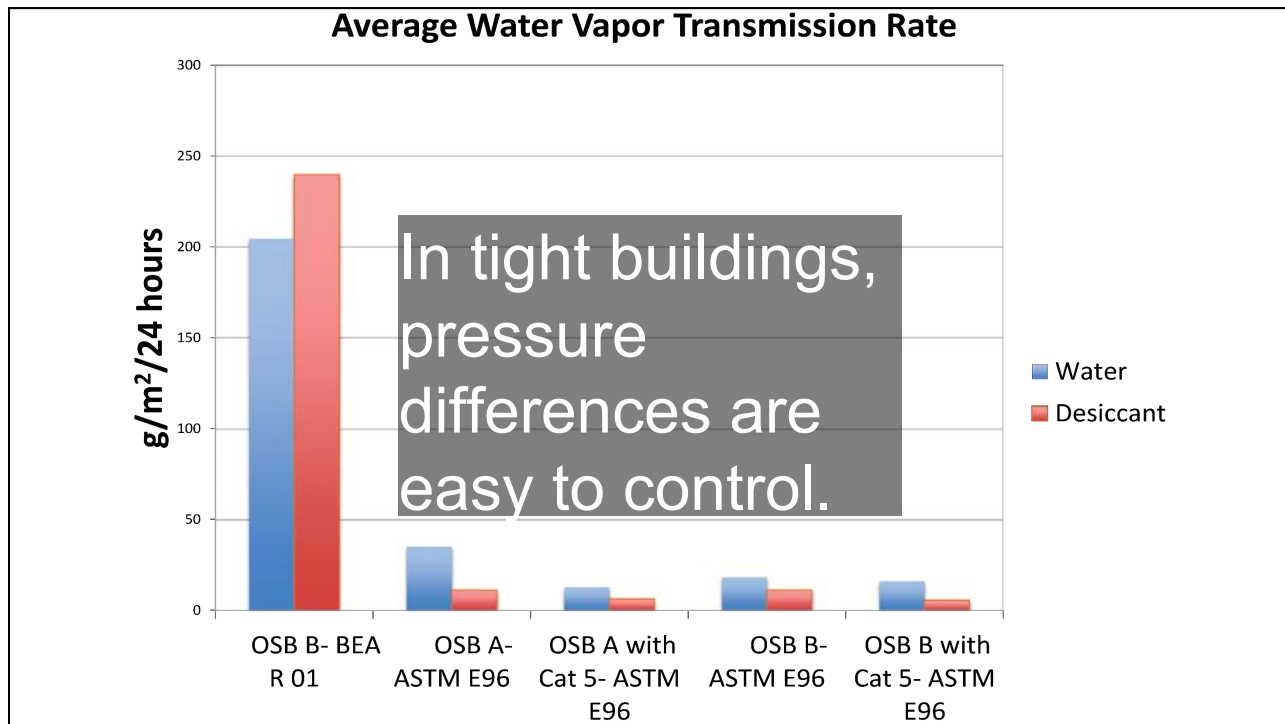

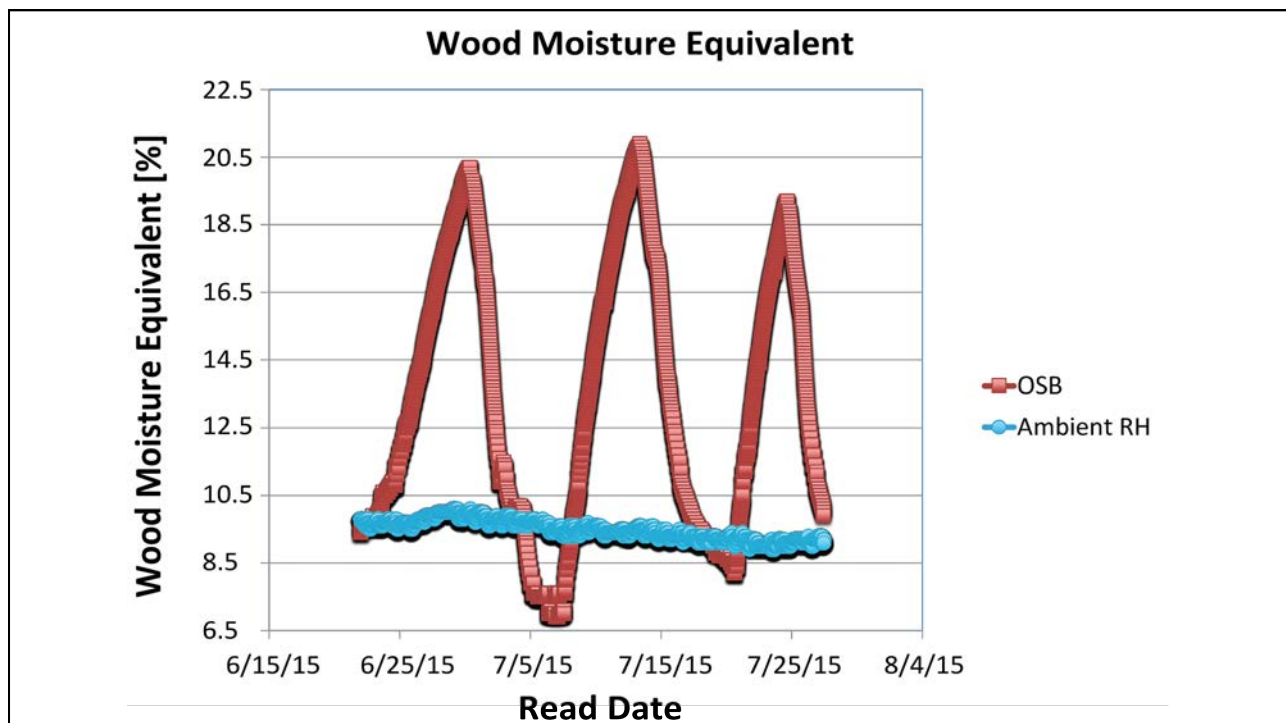
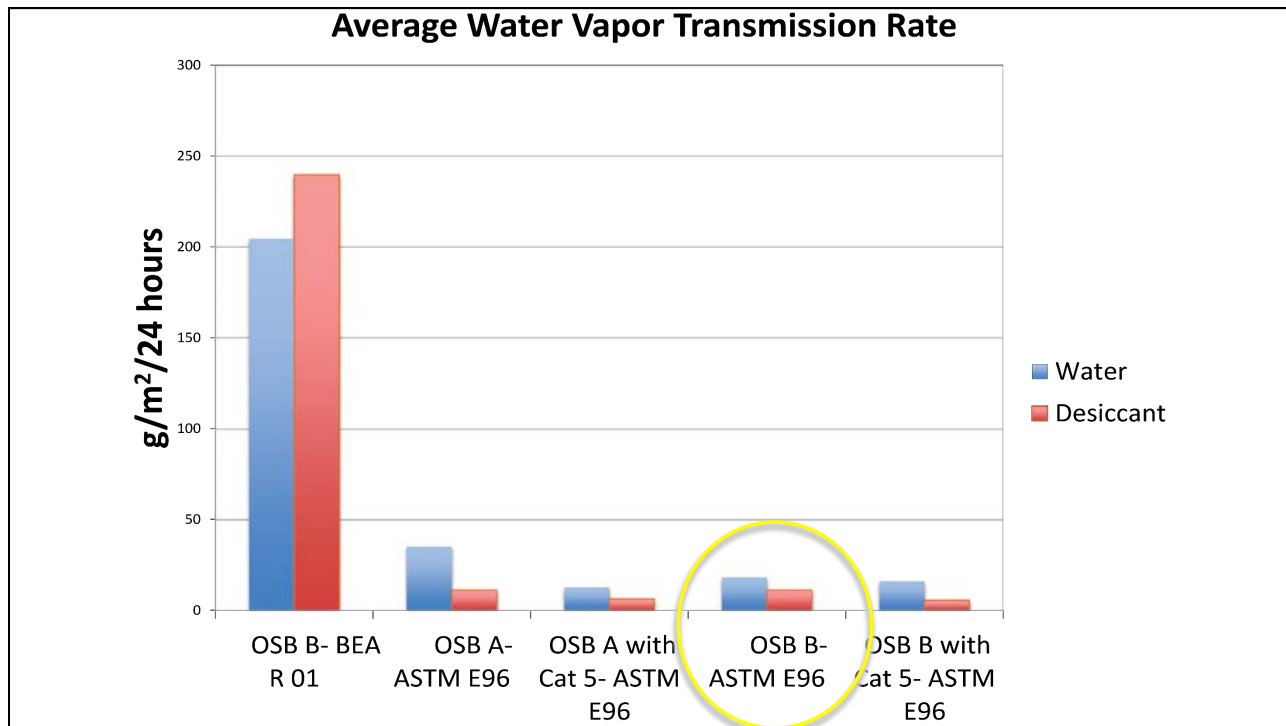

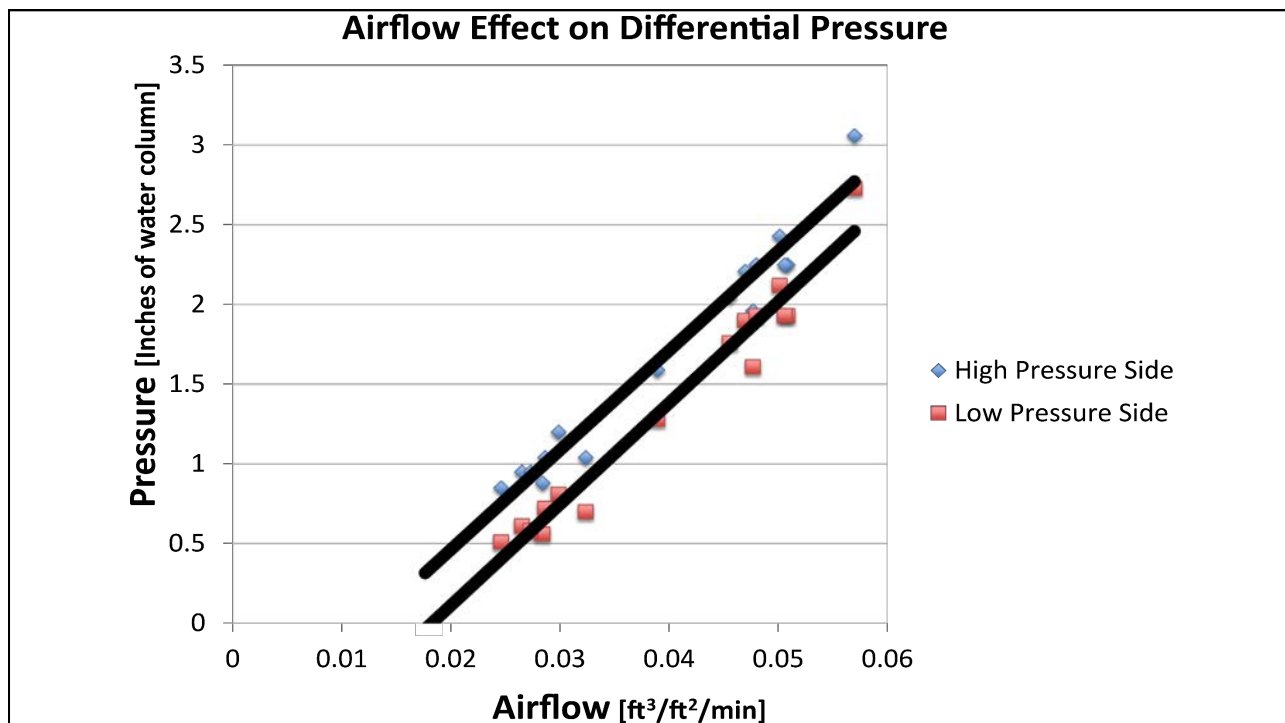
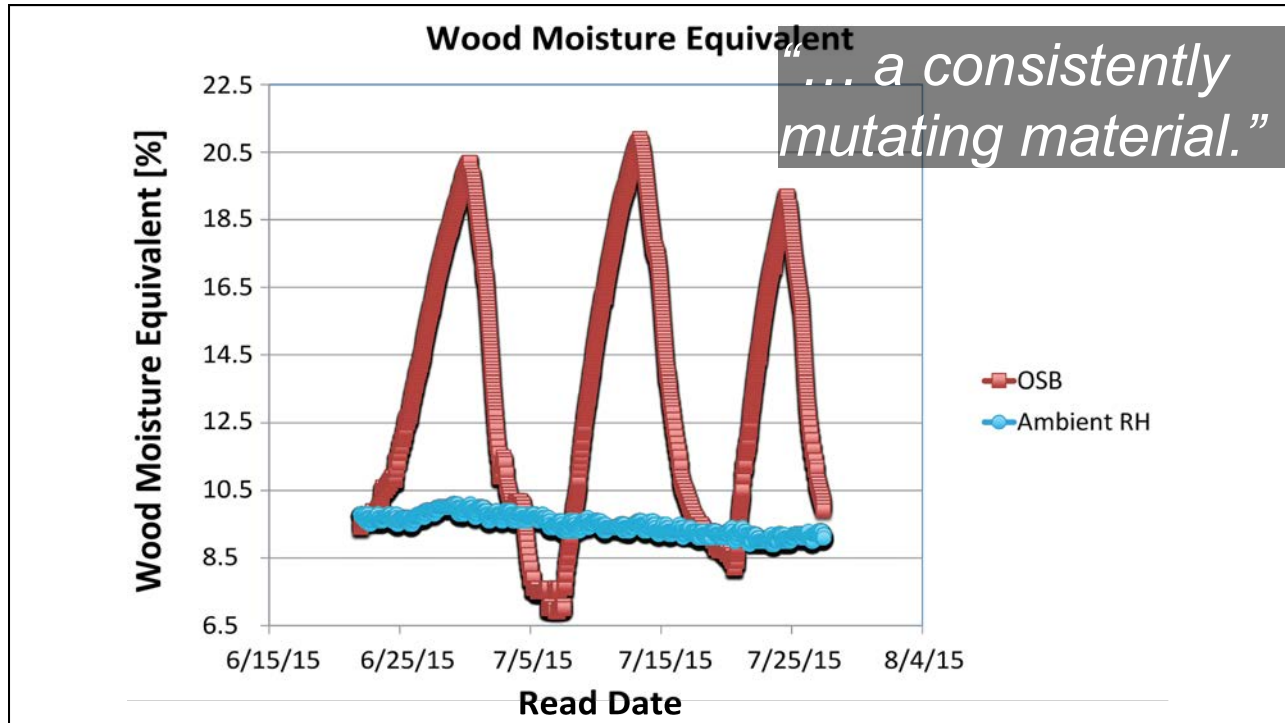

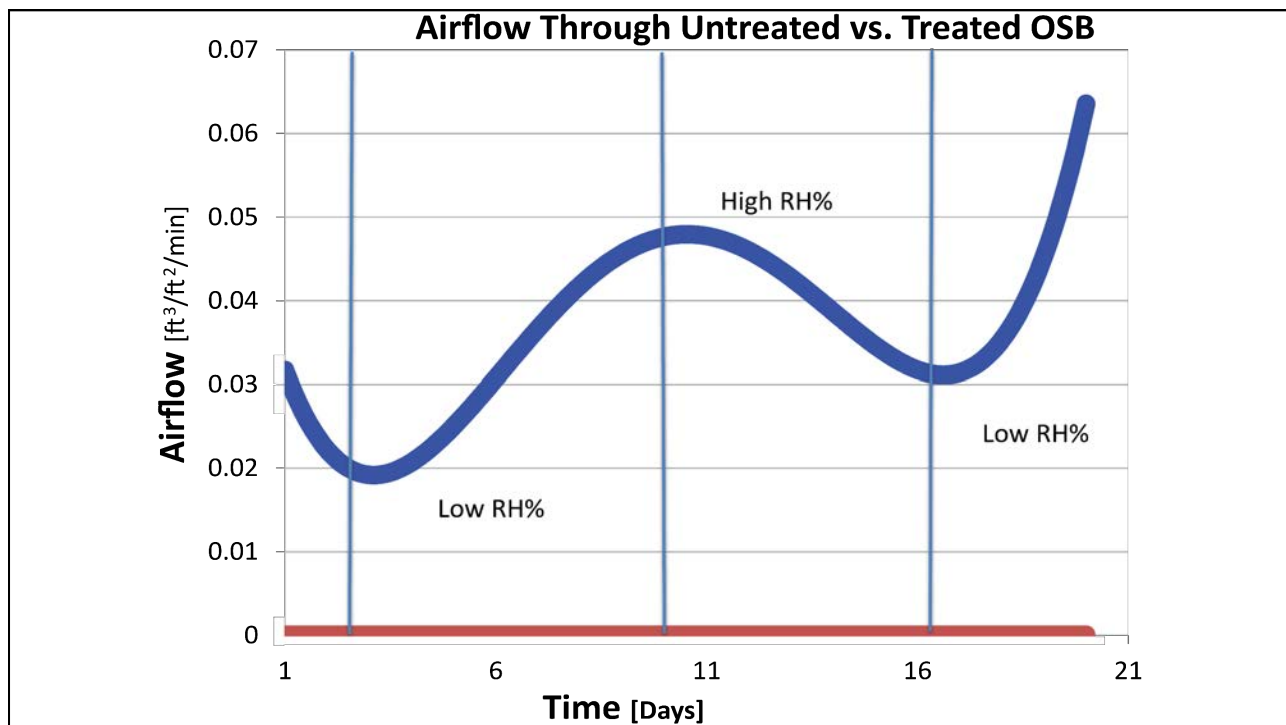
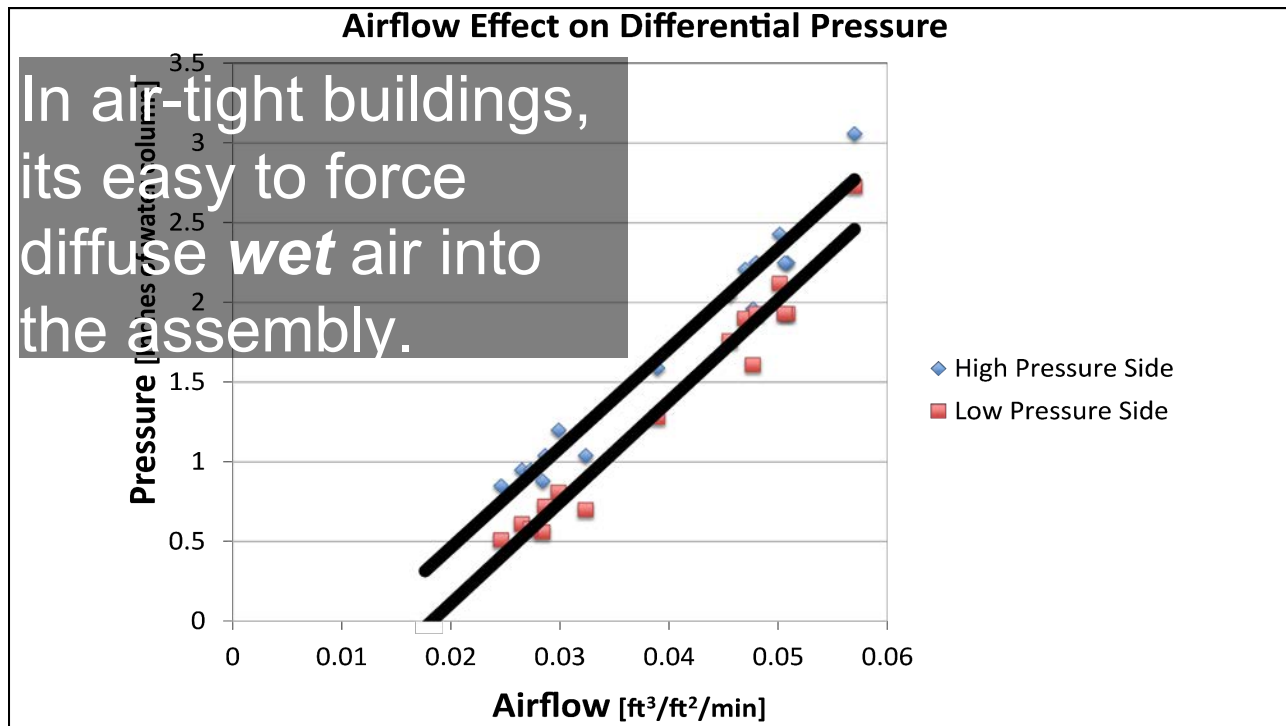

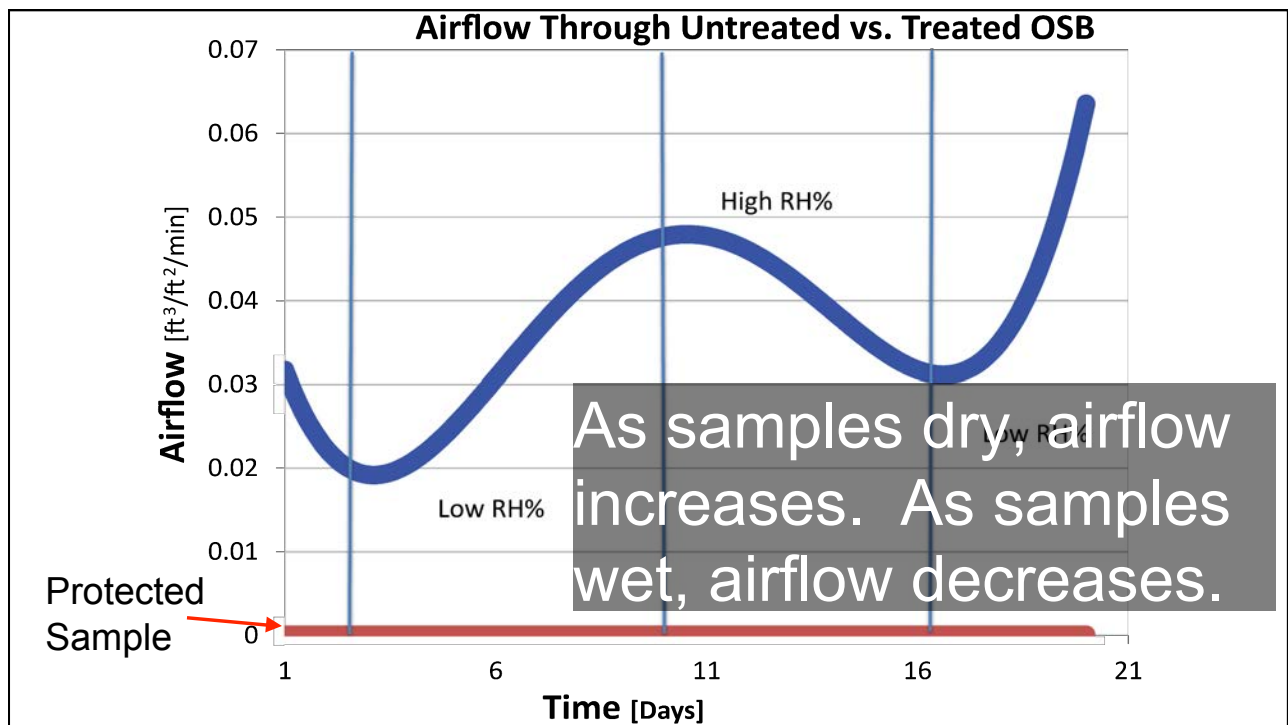
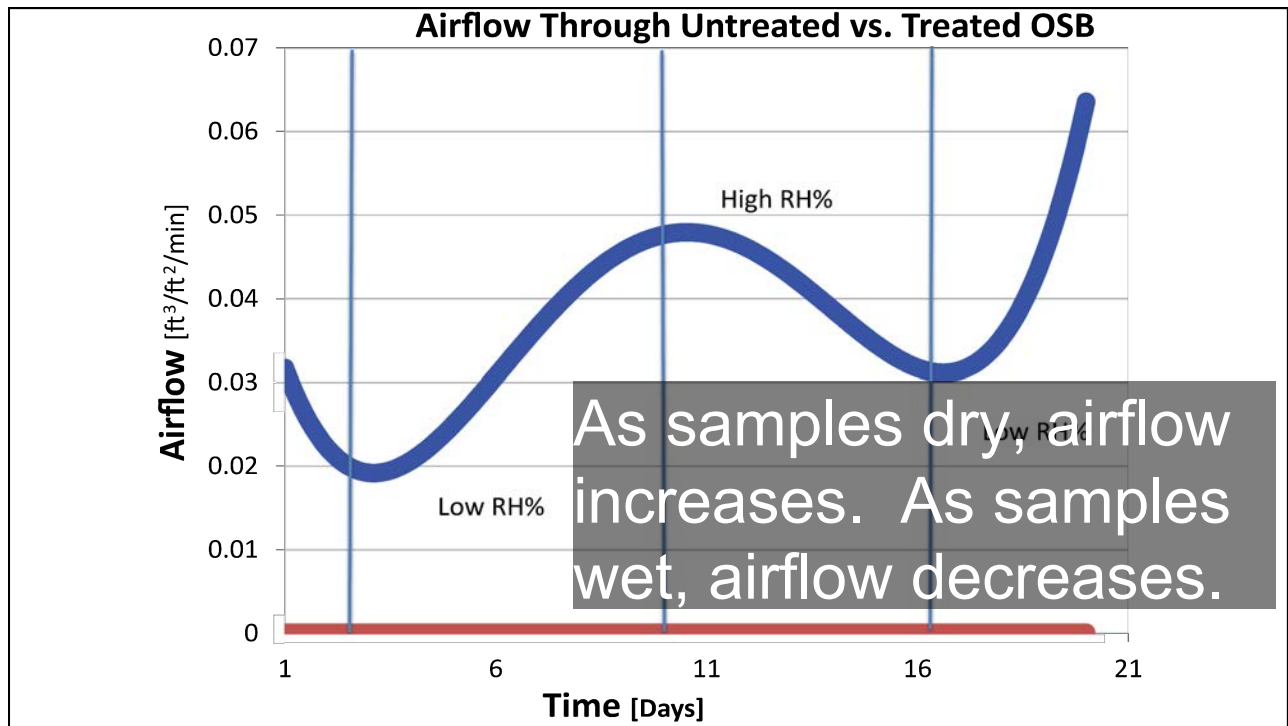

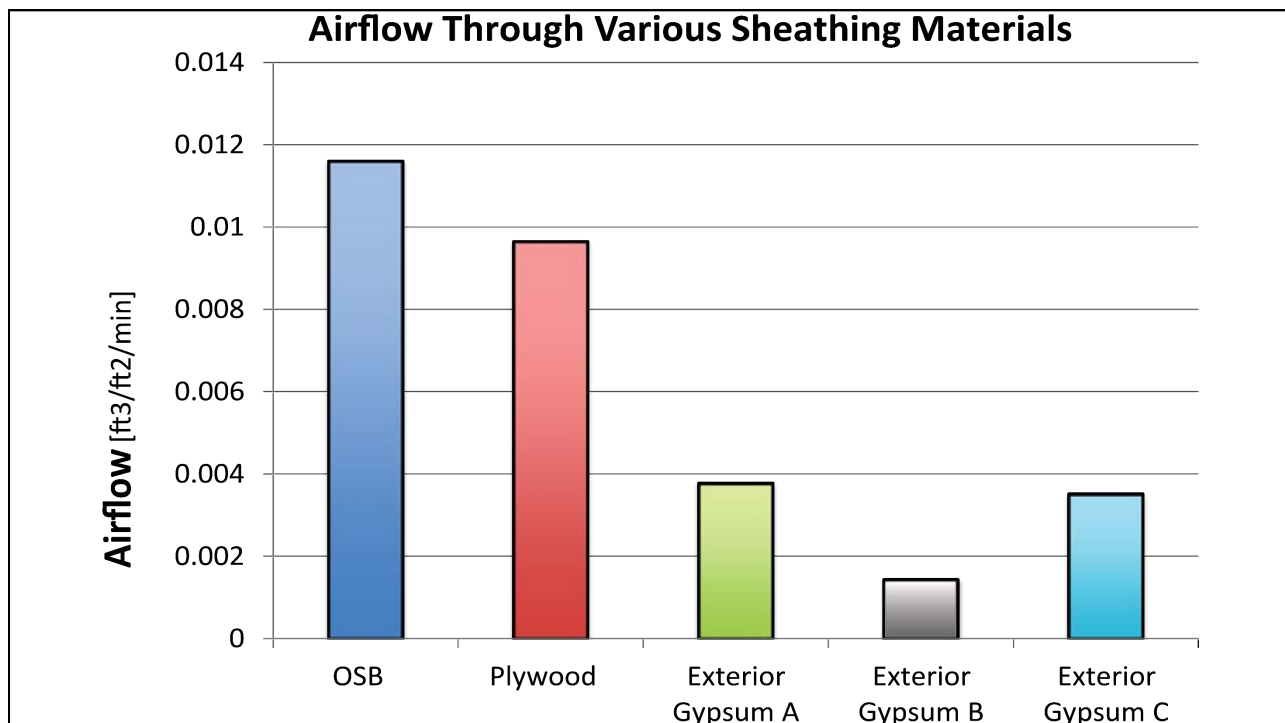
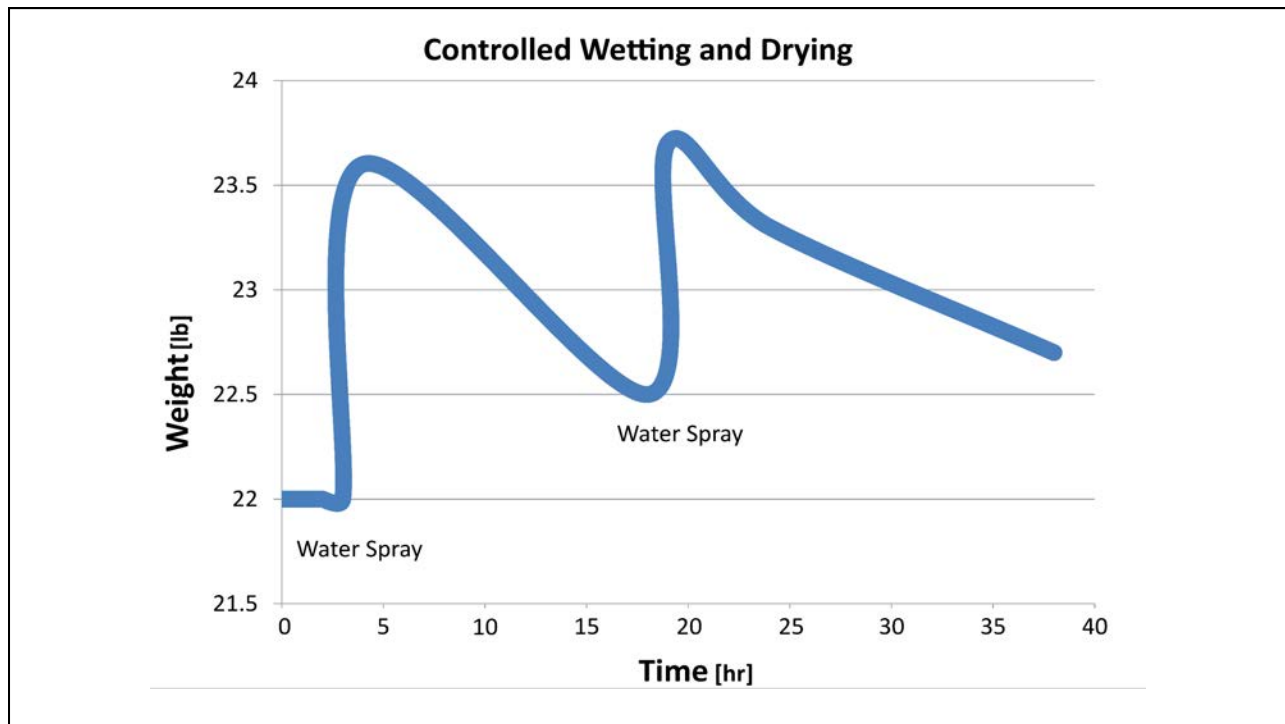

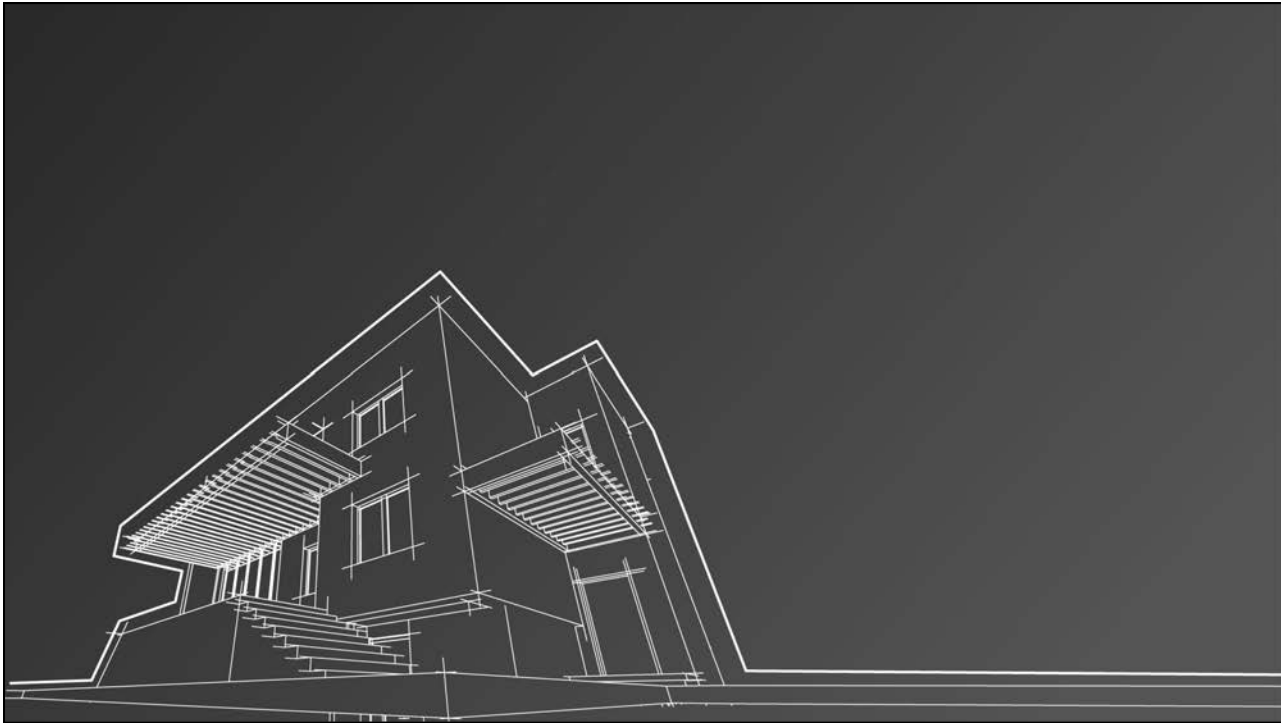

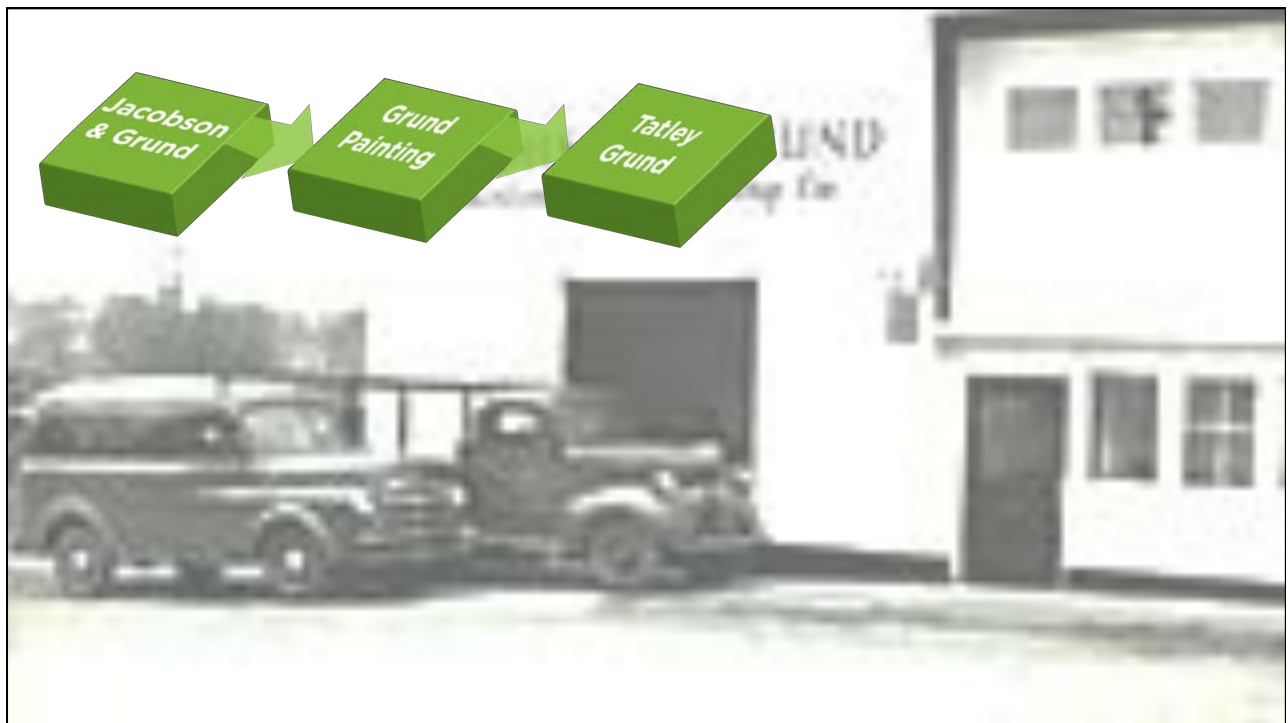

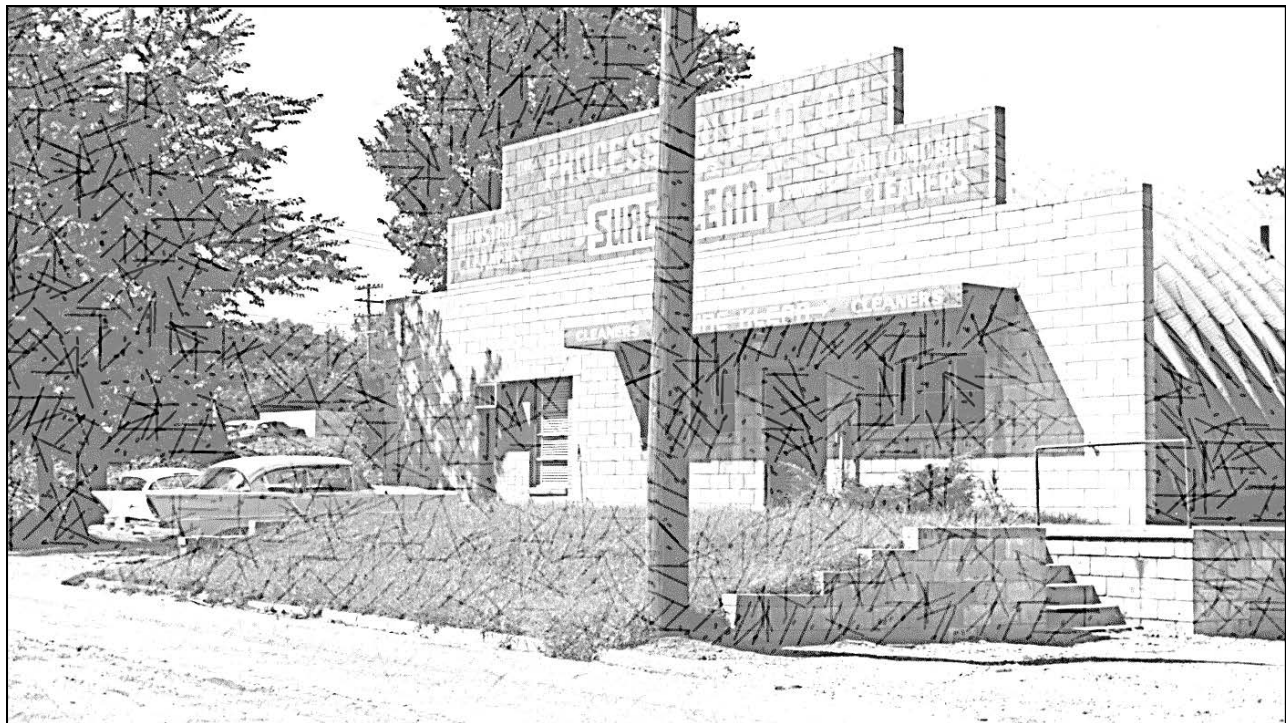
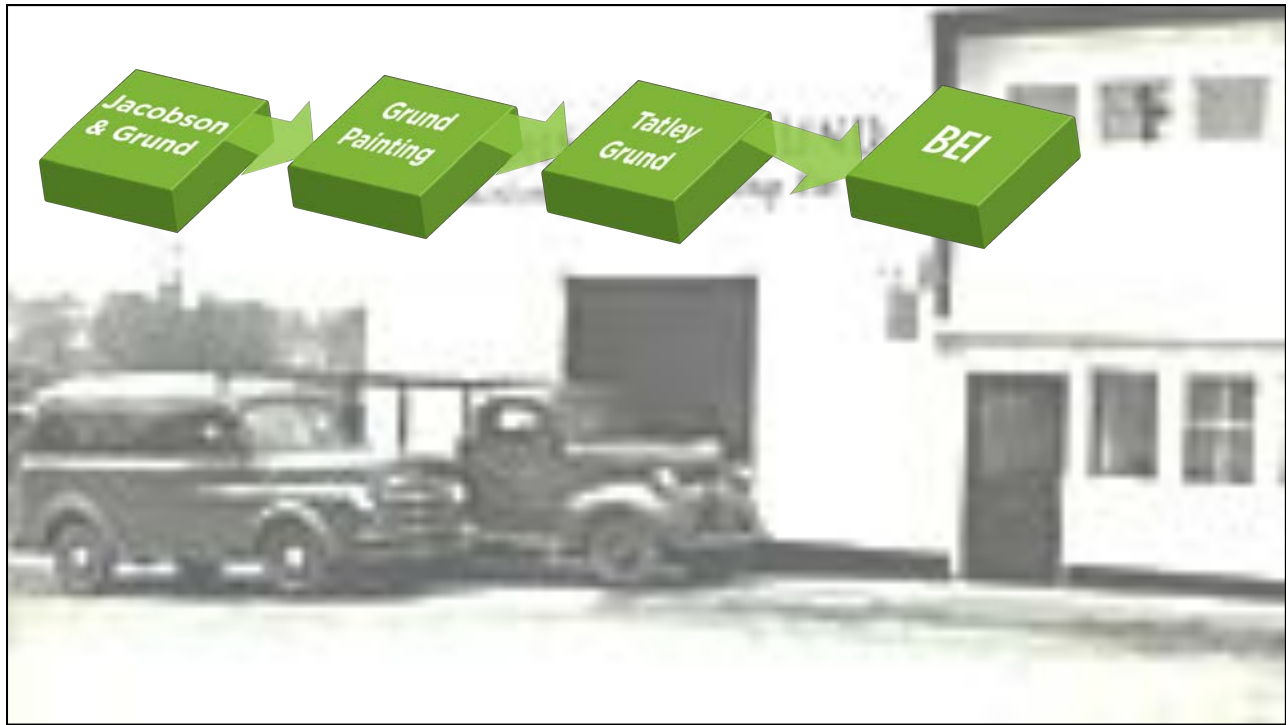

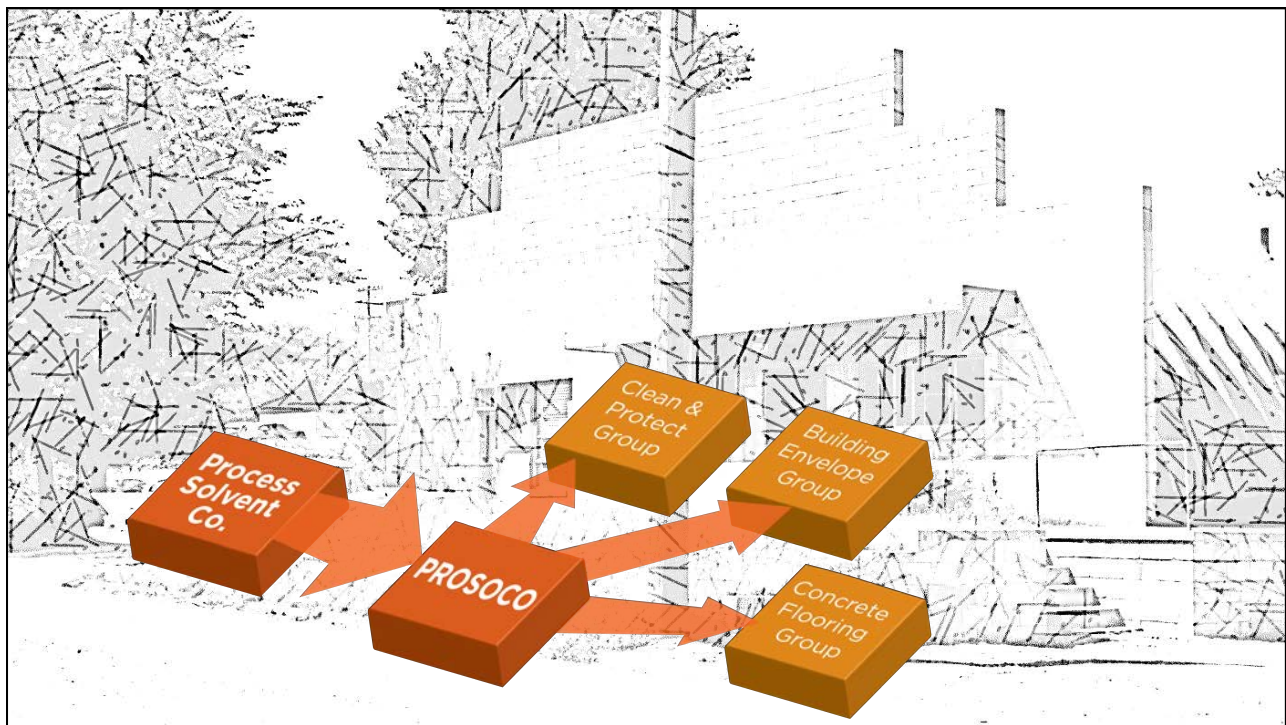
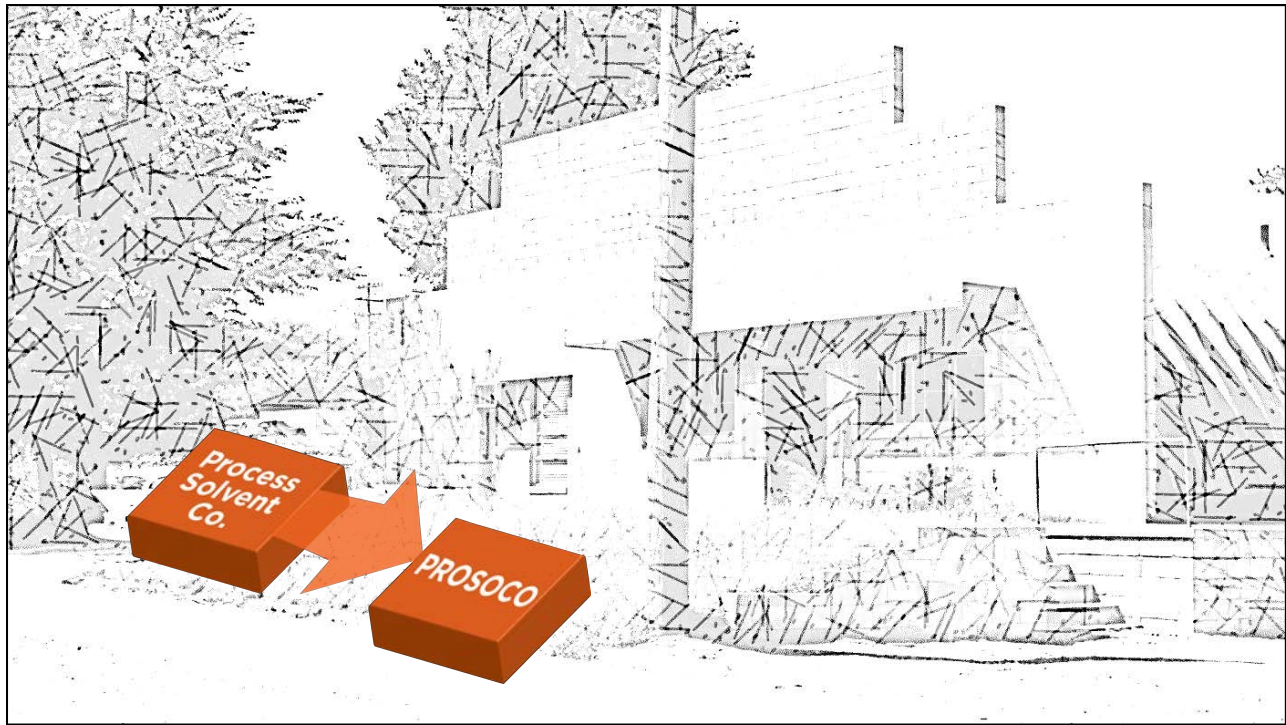

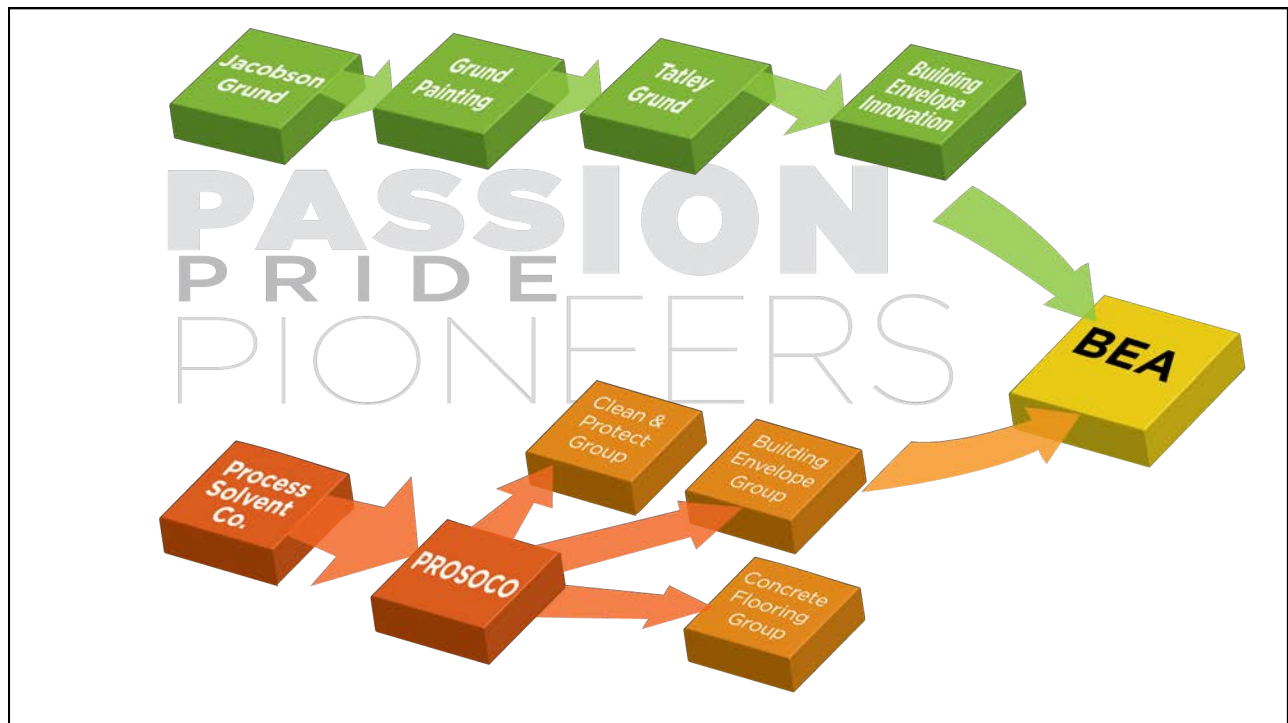
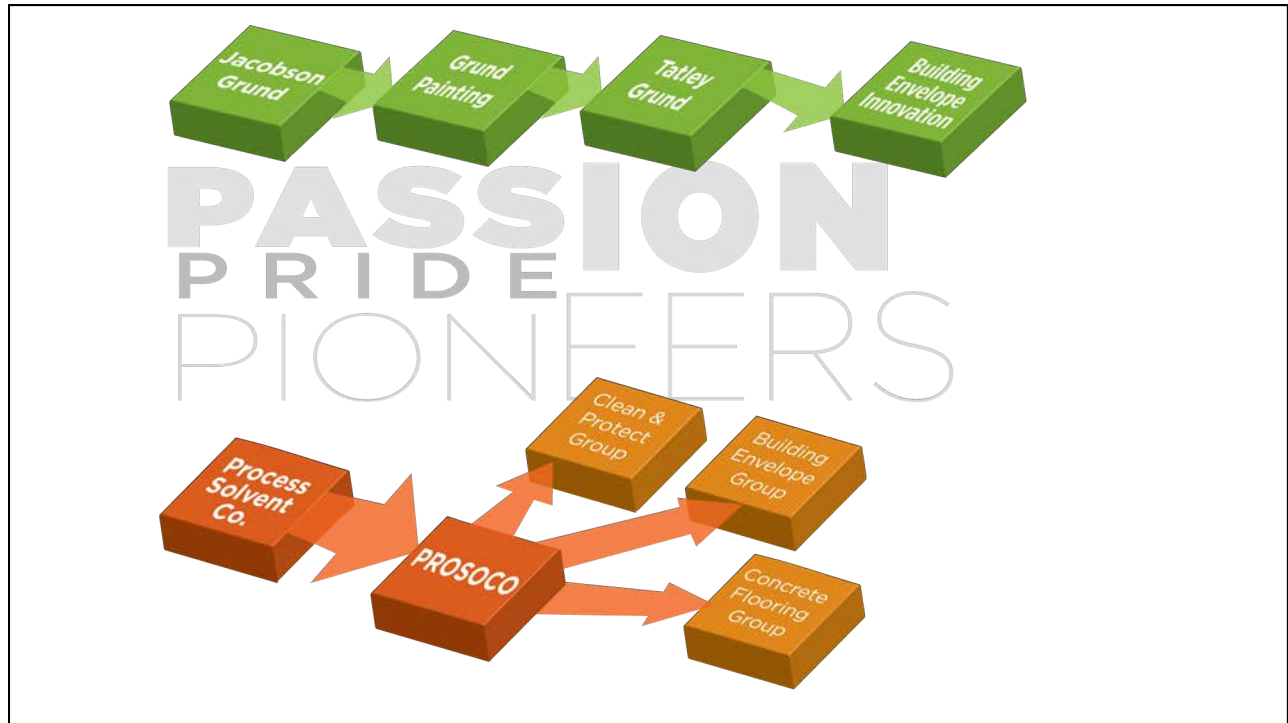



Designation: E96/E96M - 13

**Standard Test Methods for
Water Vapor Transmission of Materials¹**



Designation: D1970/D1970M - 13a

**Standard Specification for
Self-Adhering Polymer Modified Bituminous Sheet Materials
Used as Steep Roofing Underlayment for Ice Dam
Protection¹**



Designation: C1305 - 08

**Standard Test Method for
Crack Bridging Ability of Liquid-Applied Waterproofing
Membrane¹**

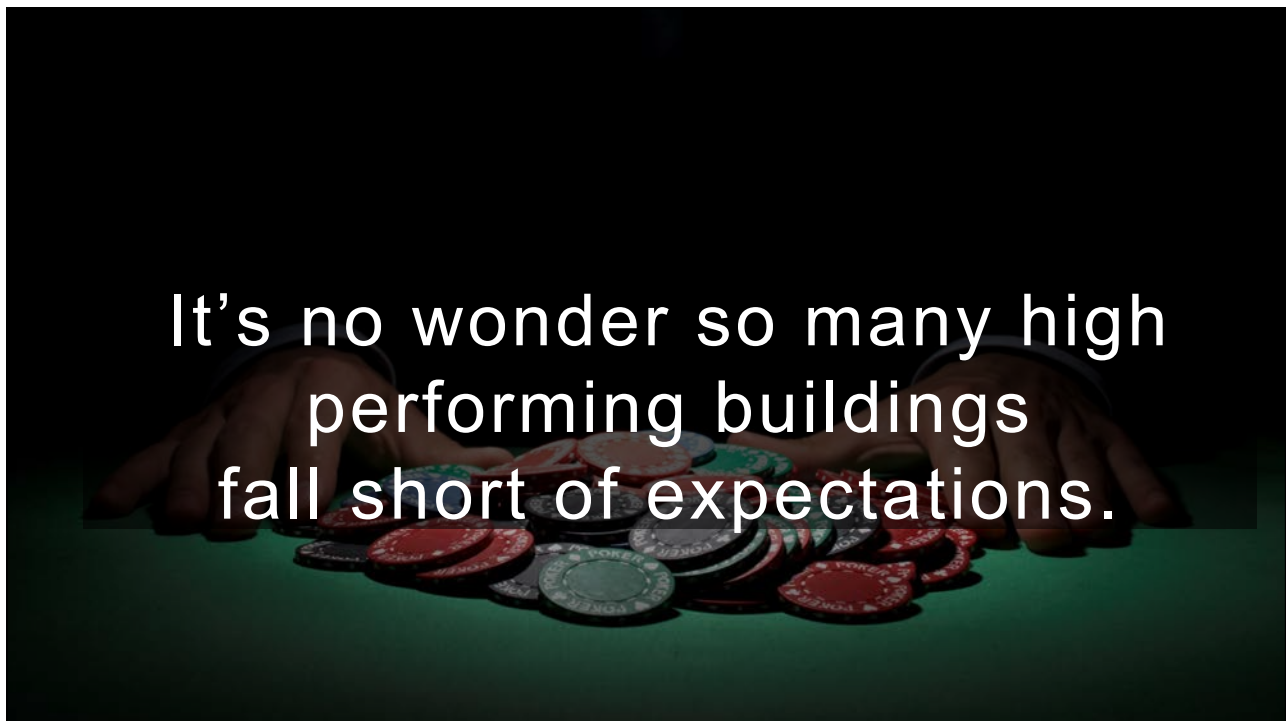

TOM SCHNEIDER DISCUSSES E 331
Create composite of all air barrier test
methods







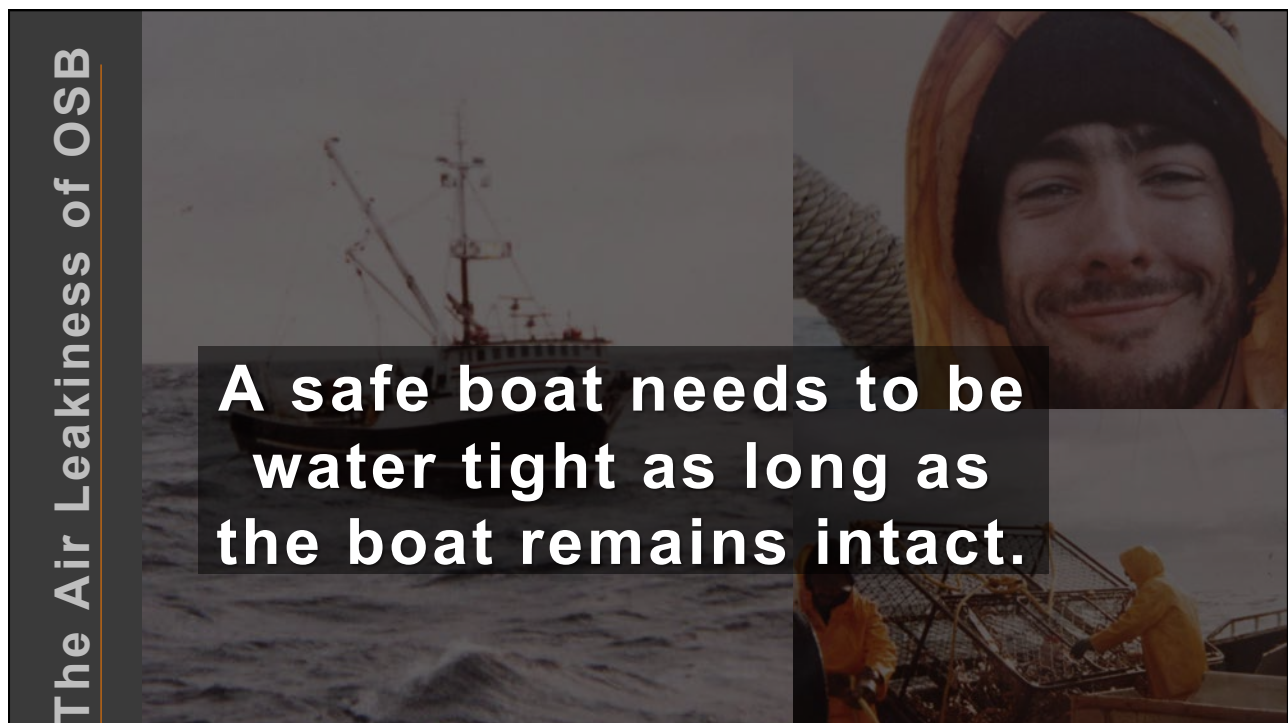

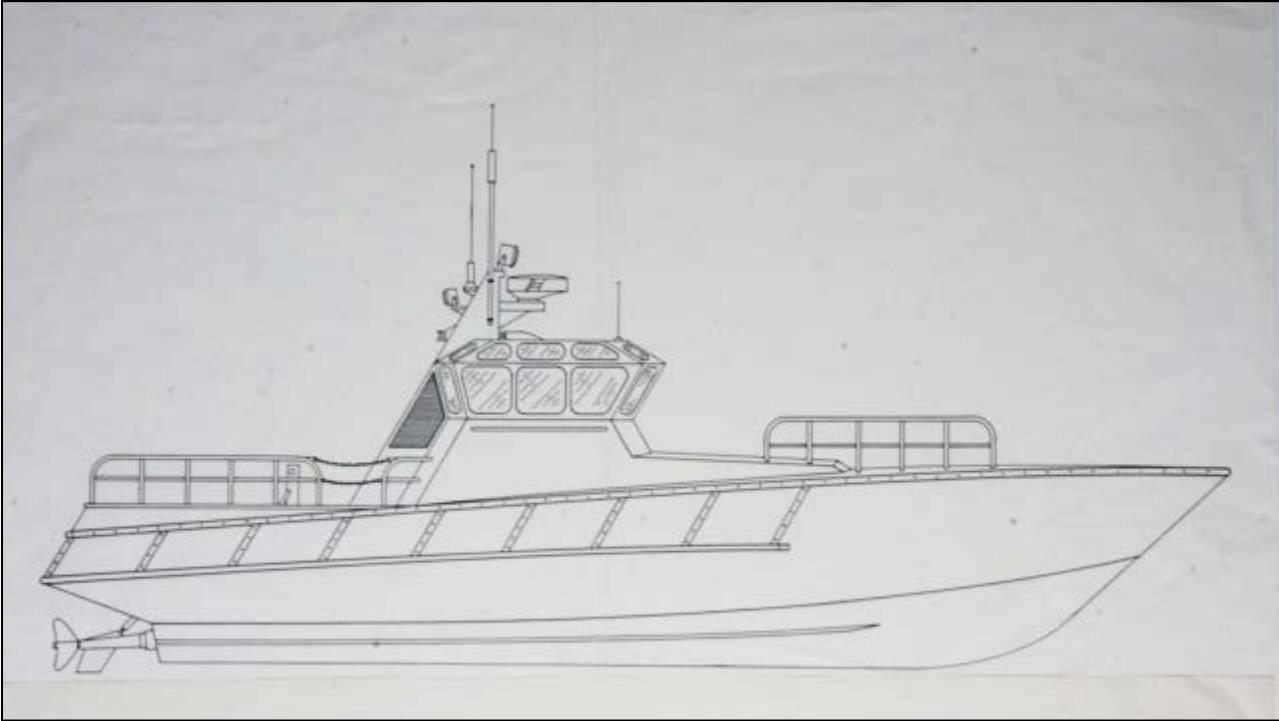

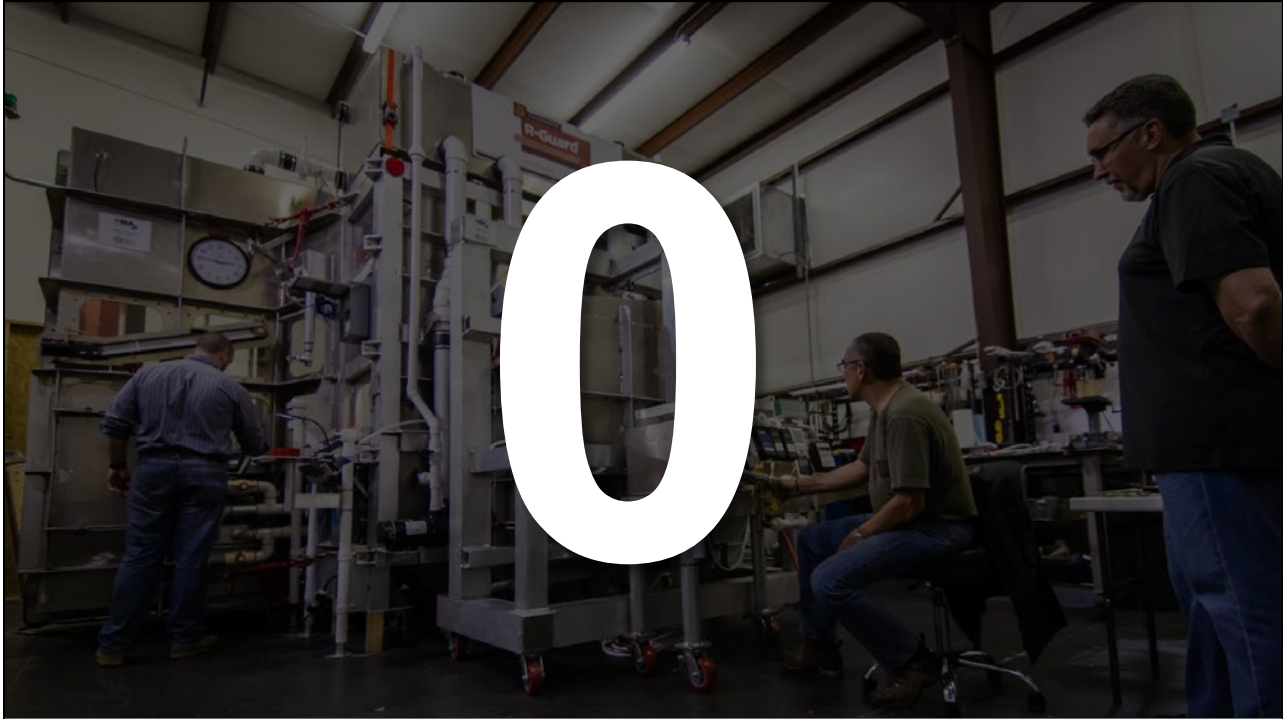







The Air Leakiness of OSB

Tidal Surge Tank

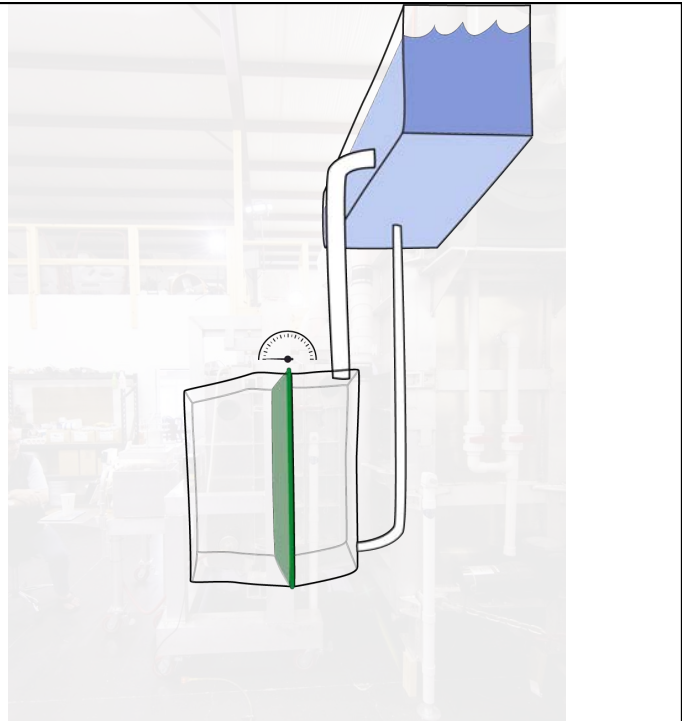

The Air Leakiness of OSB

Tidal Surge Tank

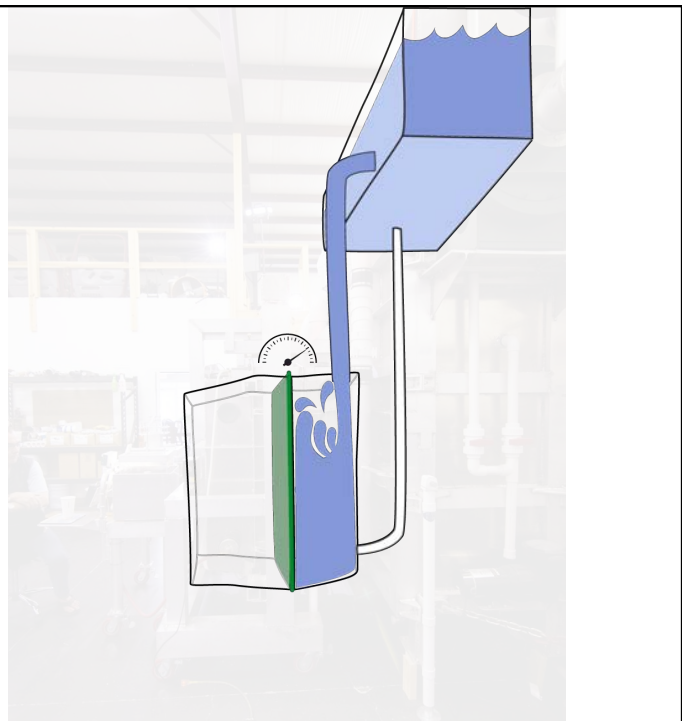

The Air Leakiness of OSB

217 PSF

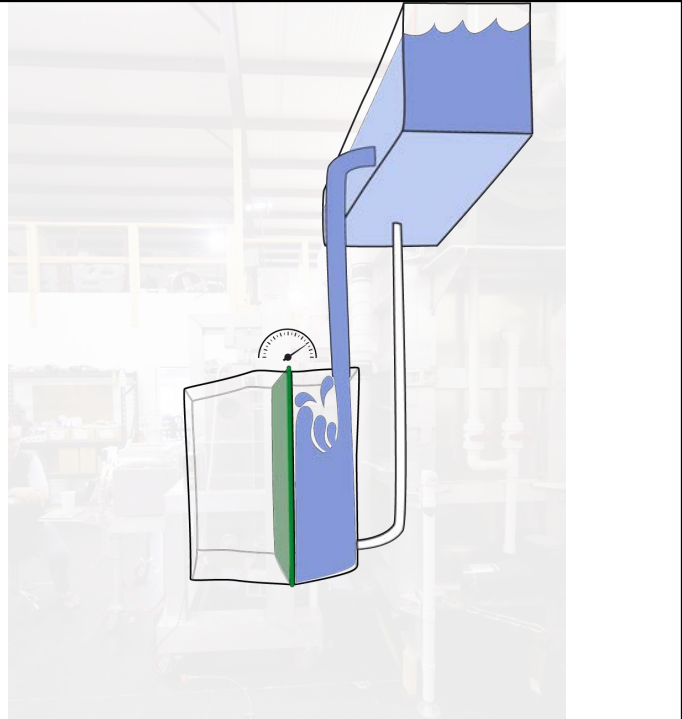

The Air Leakiness of OSB

217 PSF

278 PSF

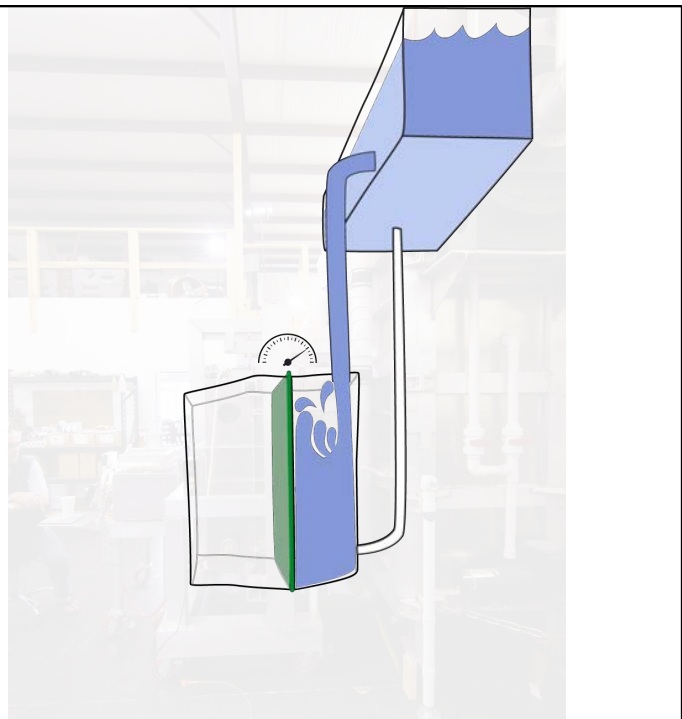

The Air Leakiness of OSB

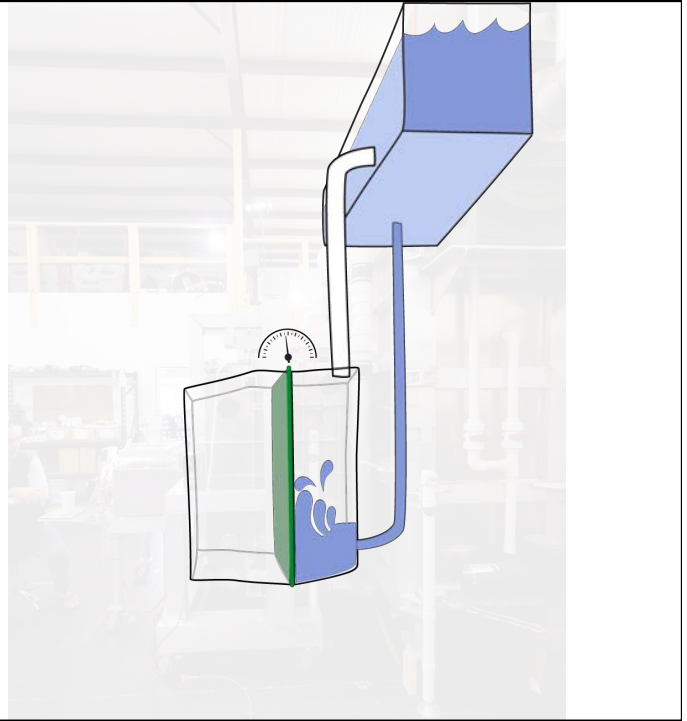

The Air Leakiness of OSB

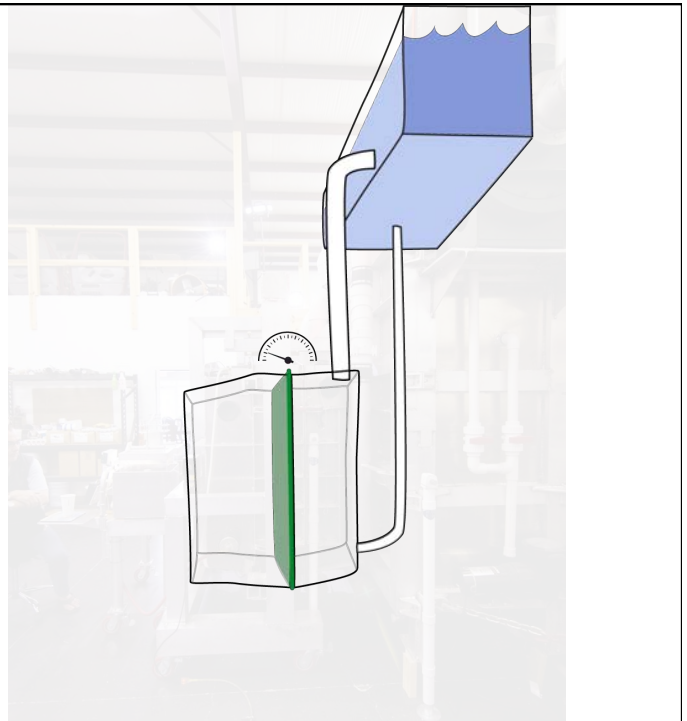

The Air Leakiness of OSB

Initiate controlled drying

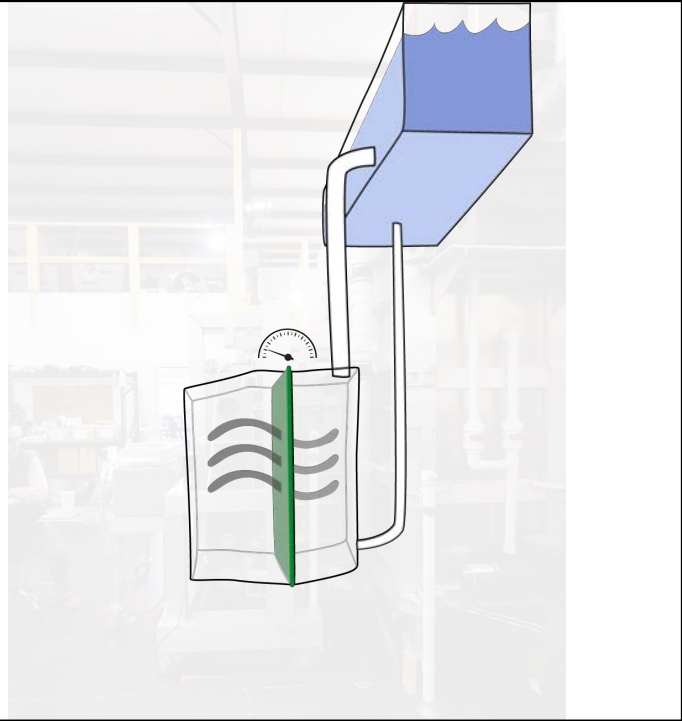



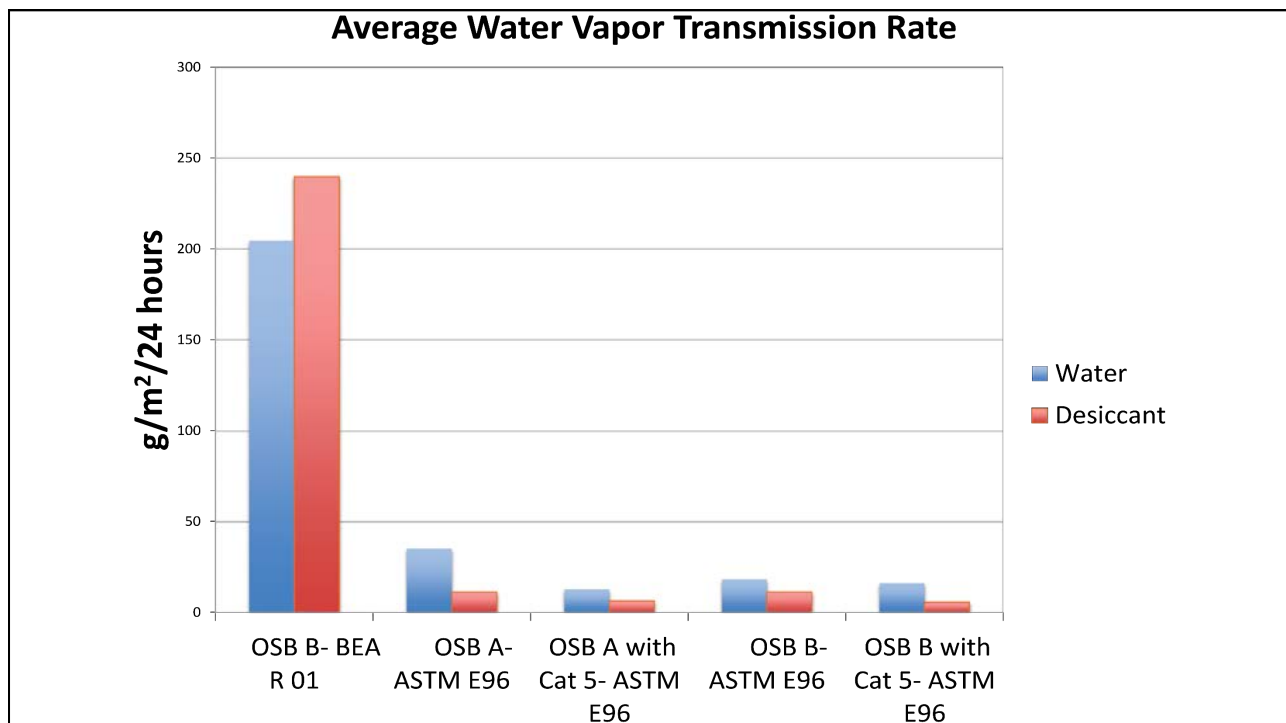
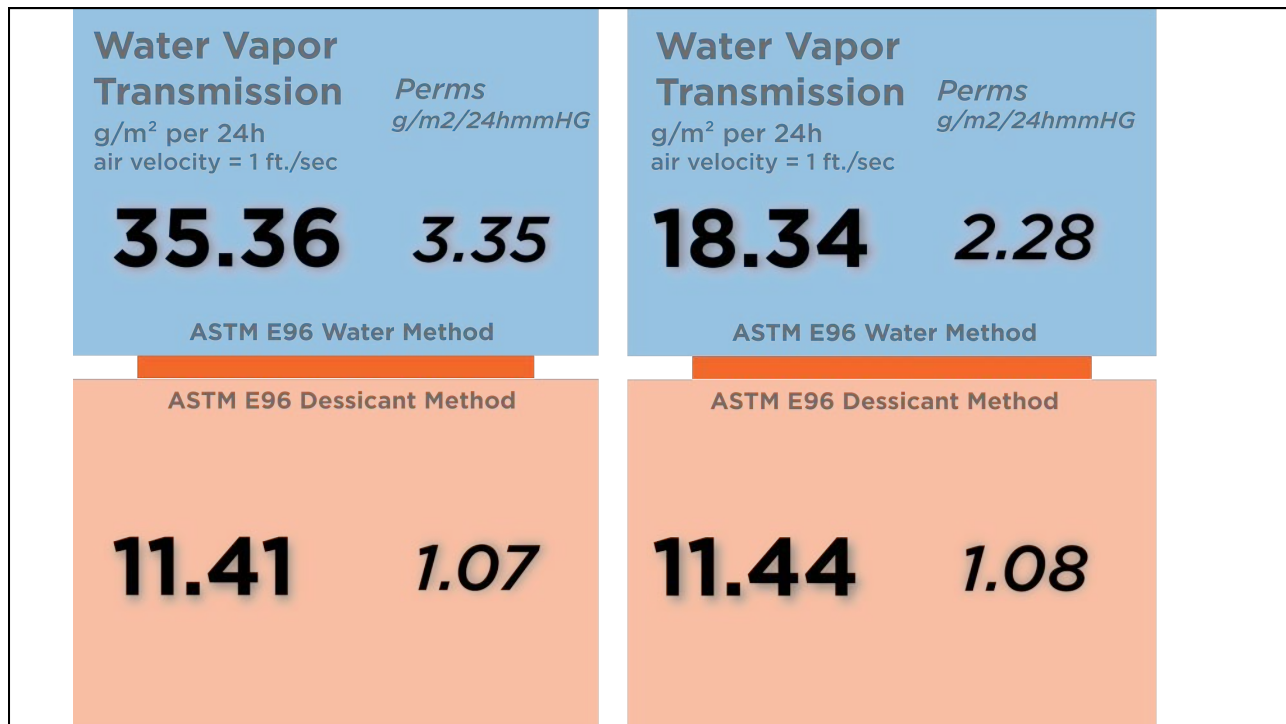

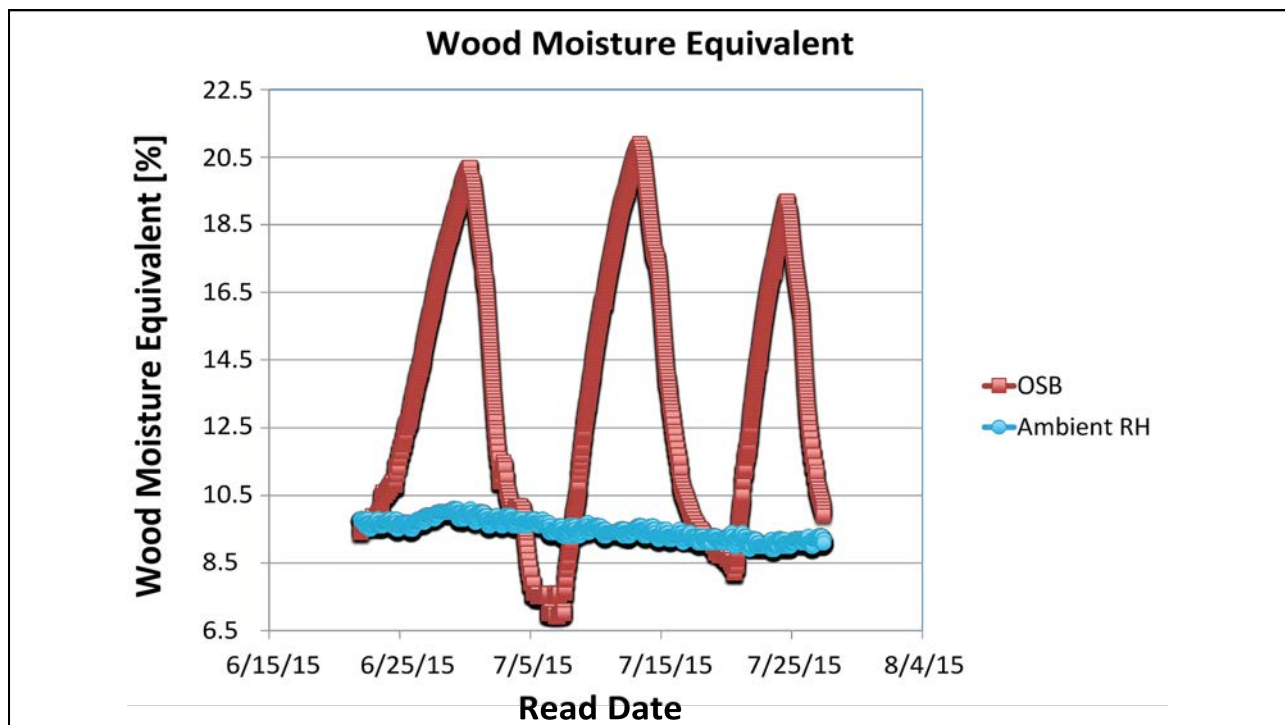
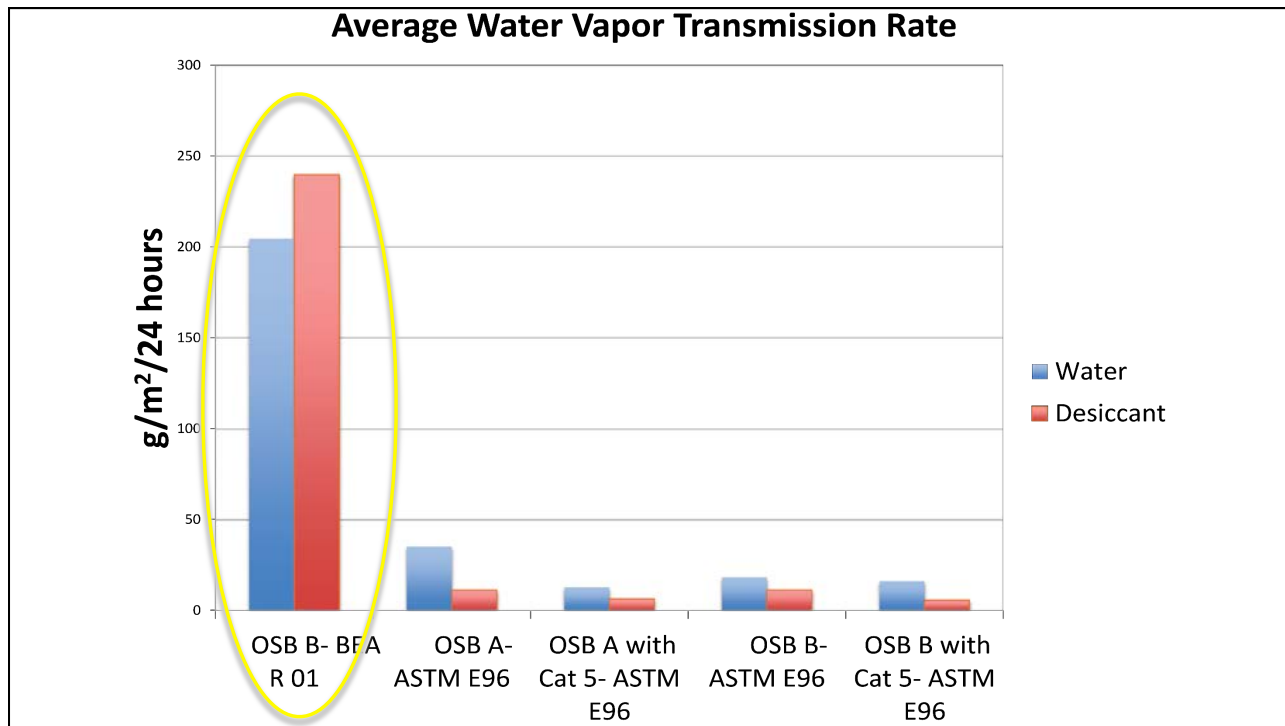

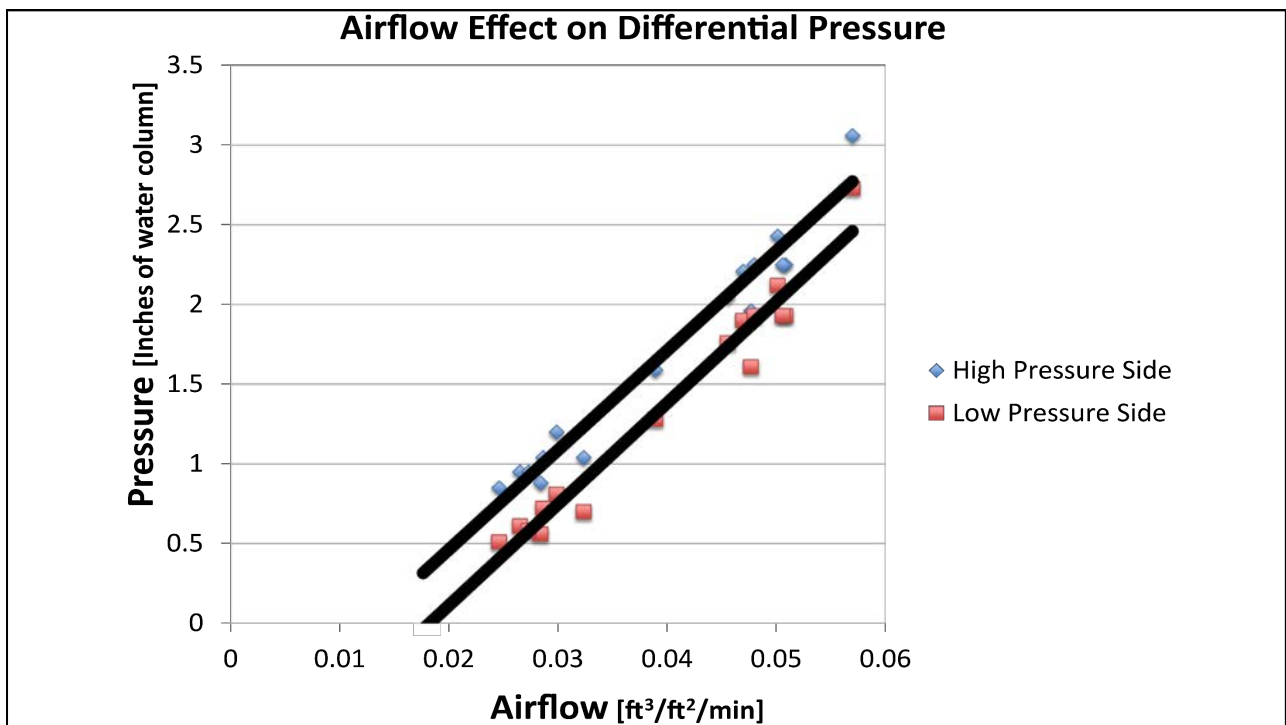
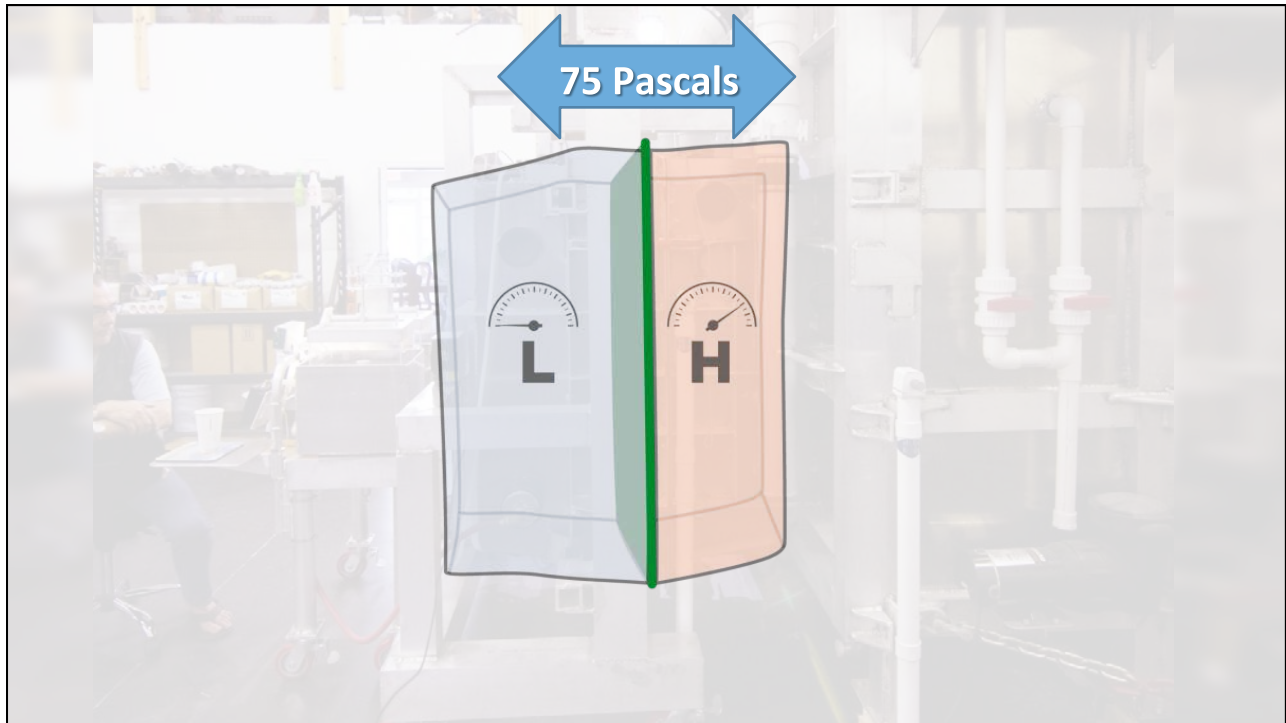

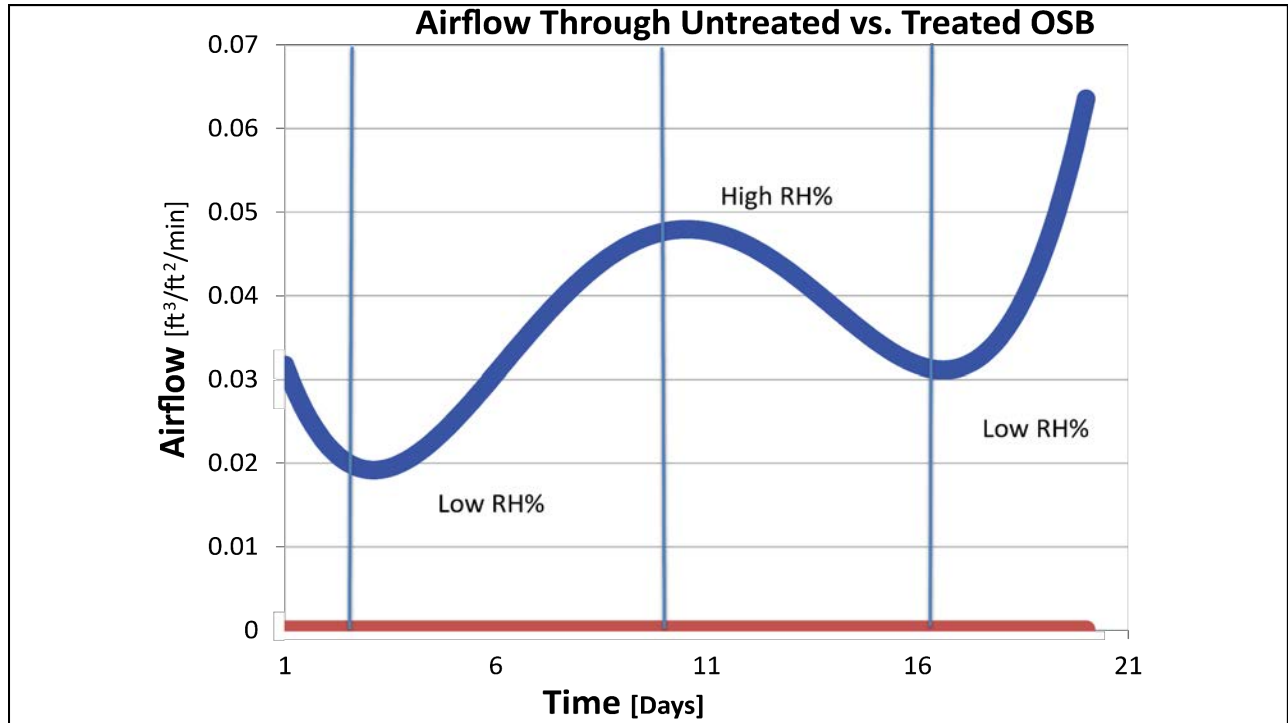

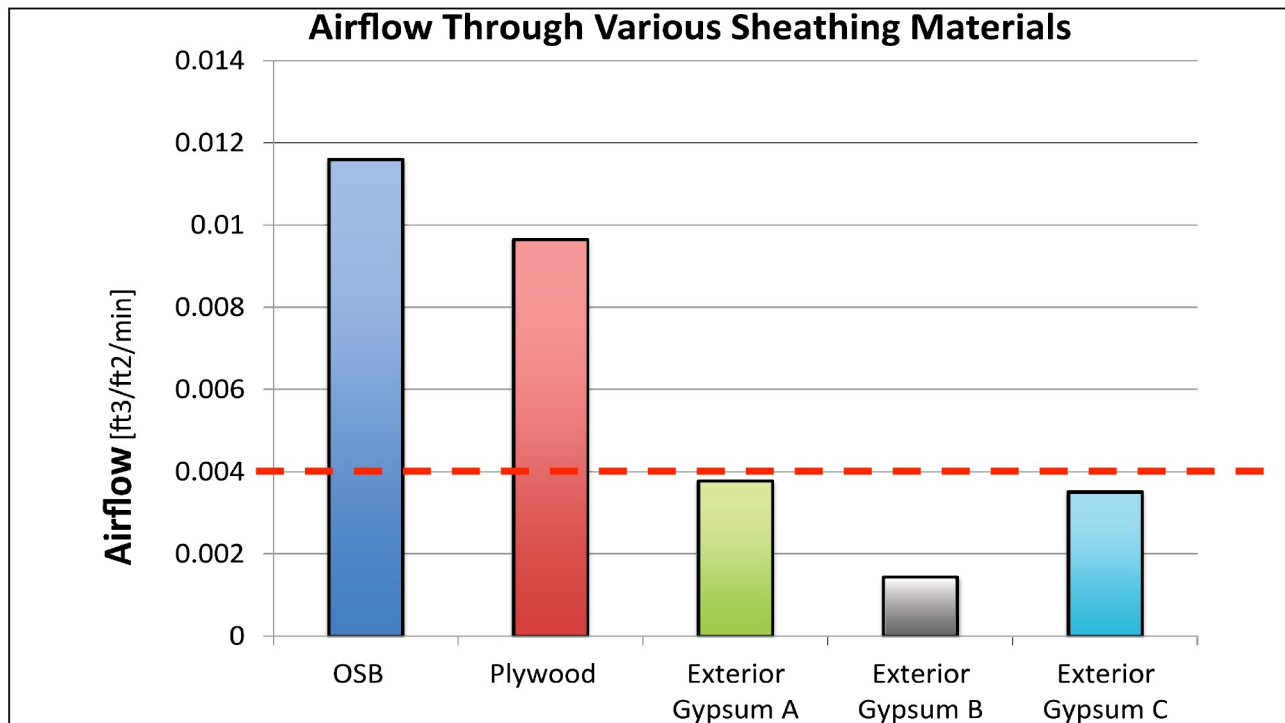
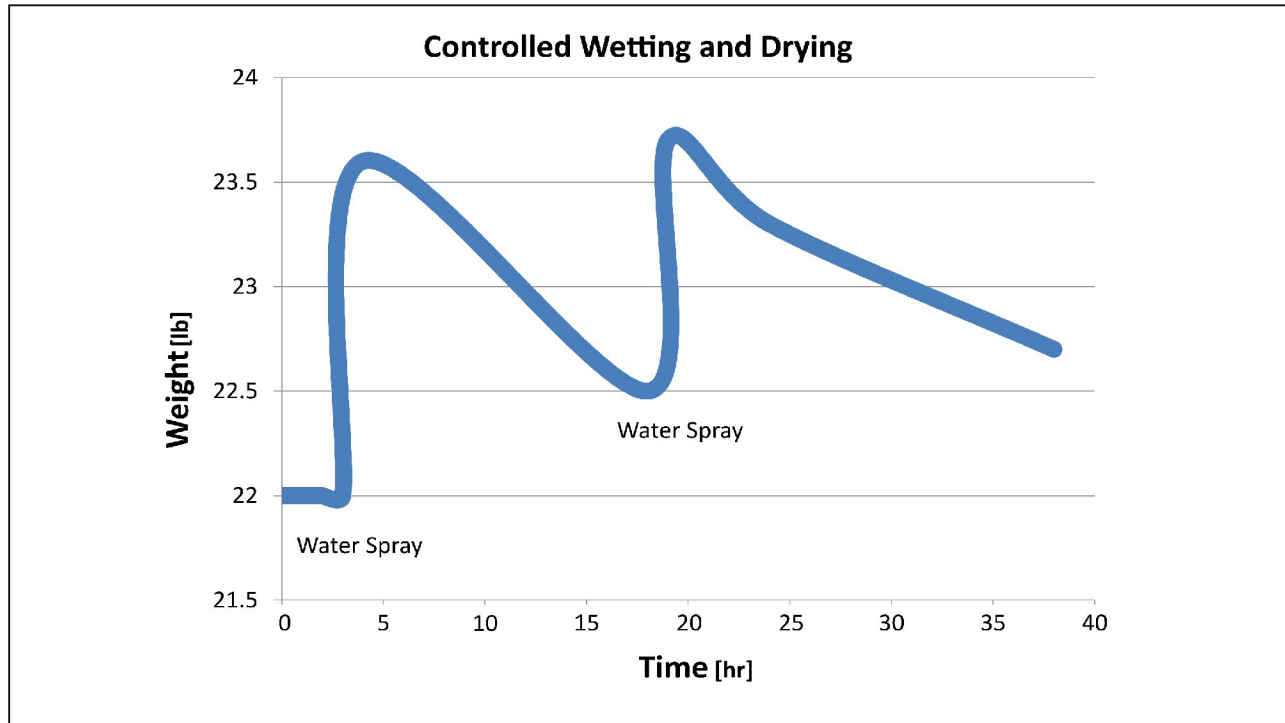

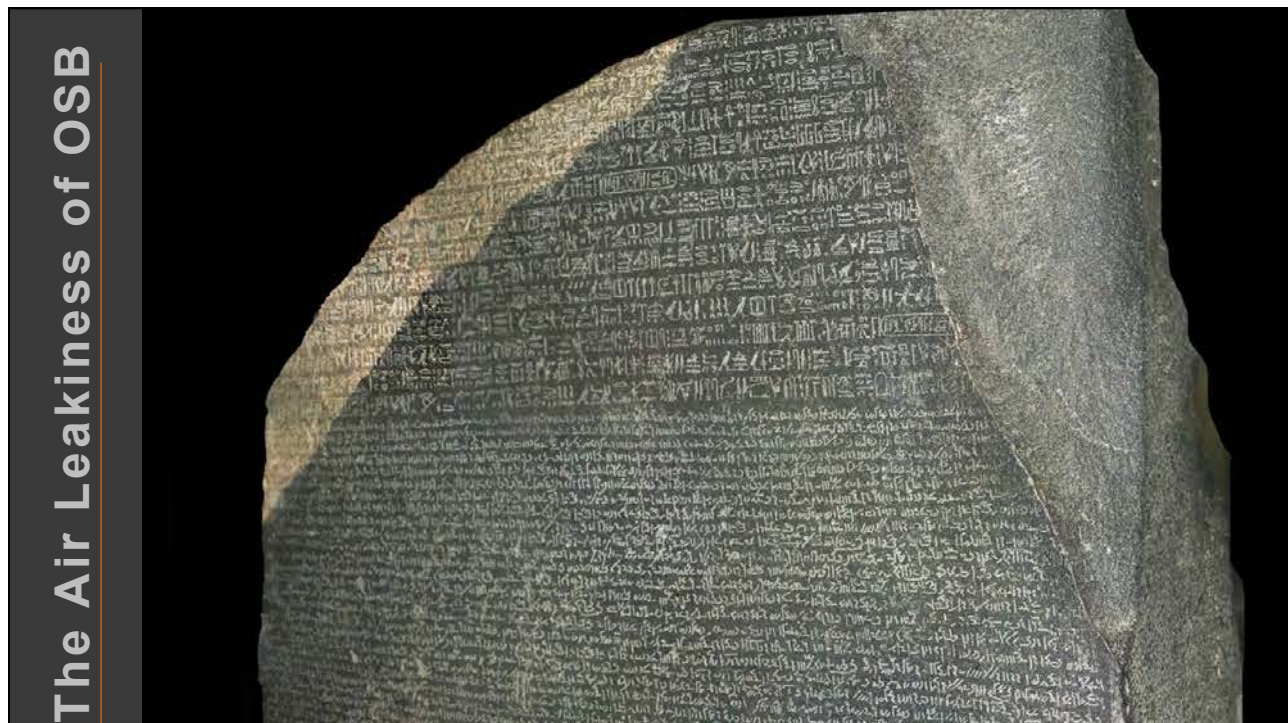
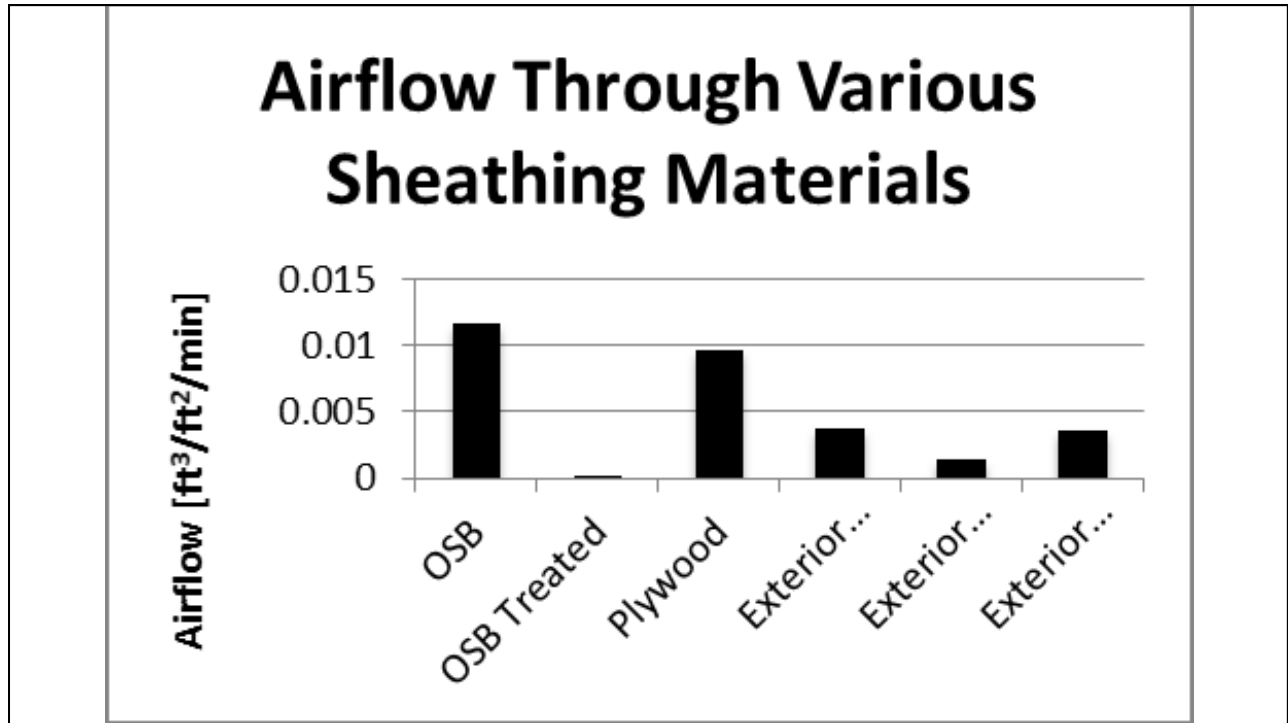

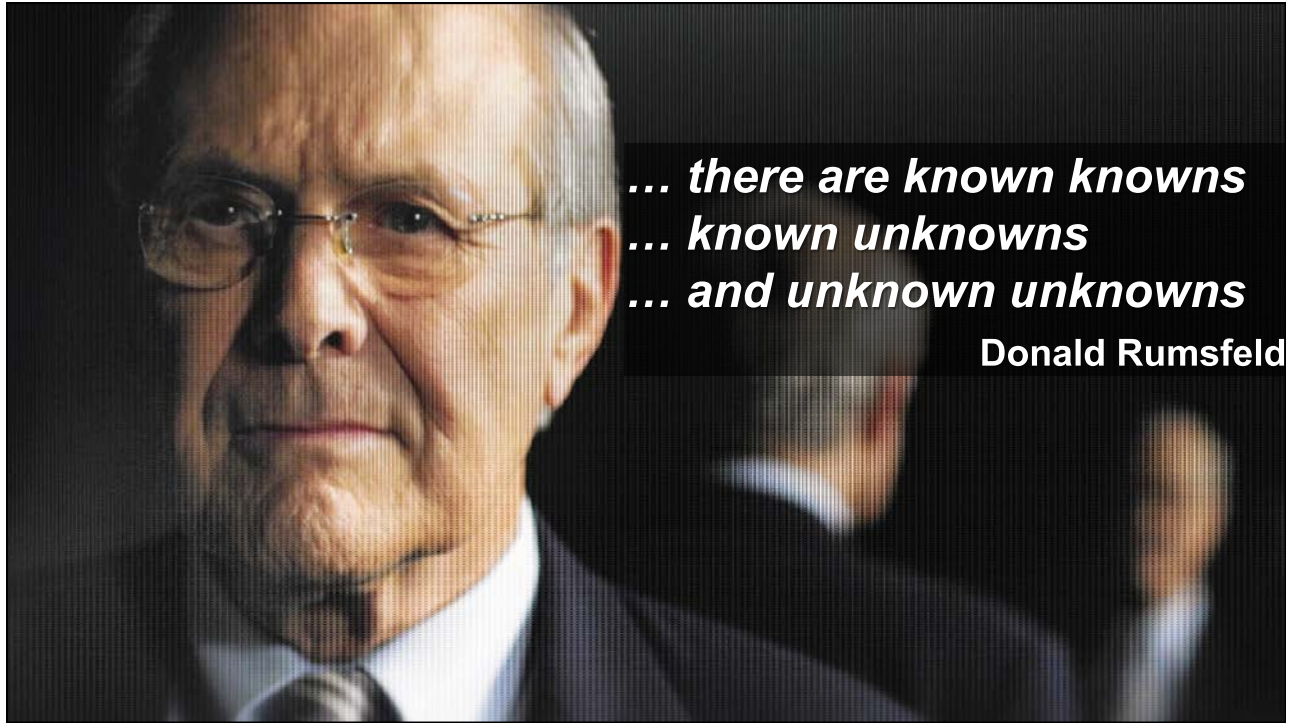





***Airflow?
Not too much ...
Not too little ...***



***Airflow?
Not too much ...
Not too little ...
Just right.***

The Air Leakiness of OSB

Measuring air and moisture flow through building materials and assemblies

David W. Boyer & Tom Schneider

PROSOCO Building Envelope Innovations

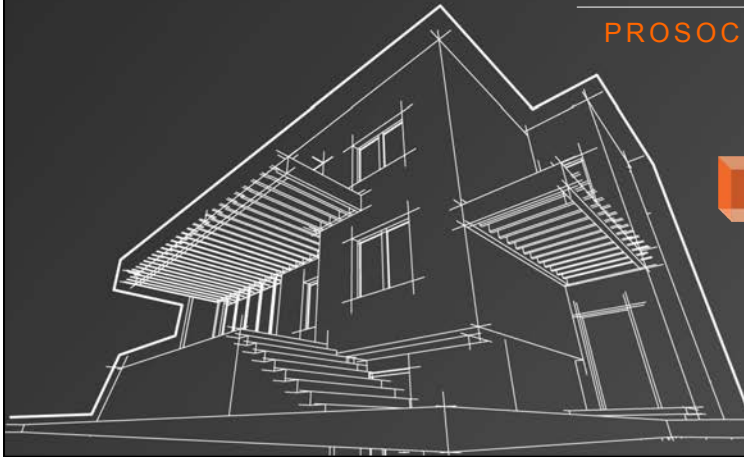

Reduced Airflow: Problems and Opportunities

Measuring air and moisture flow through building materials and assemblies

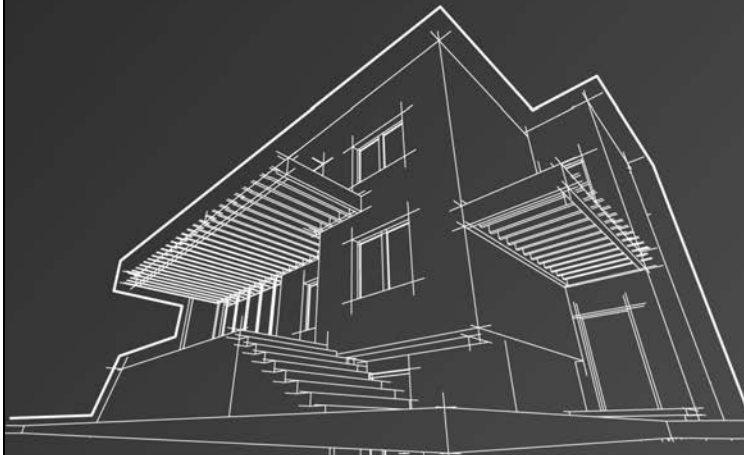

Resiliency – The Biggest Challenge to High Performing Buildings.

Measuring air and moisture flow through building materials and assemblies

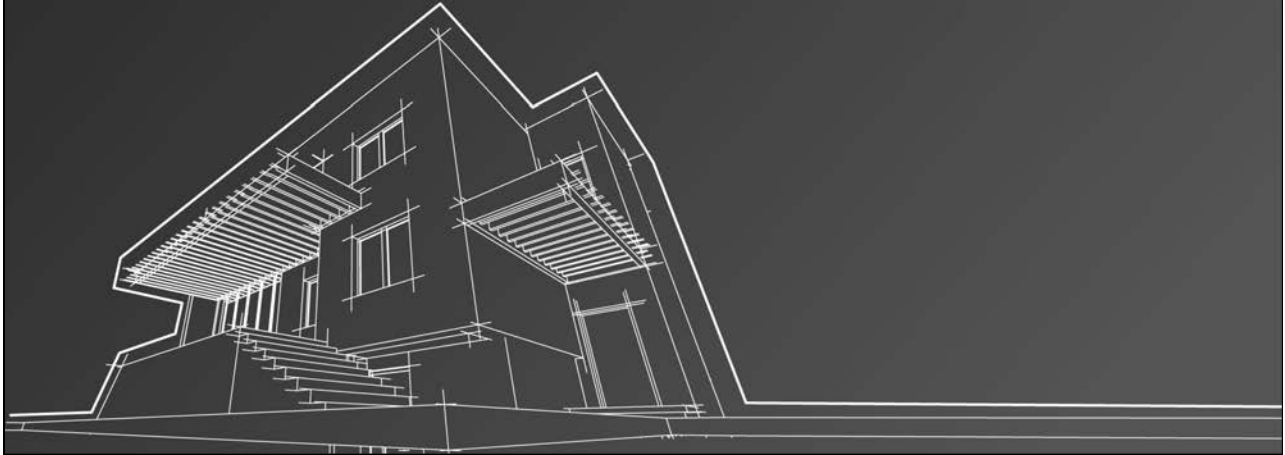

Measuring the Drying Quotient of Building Assemblies

Measuring air and moisture flow through building materials and assemblies

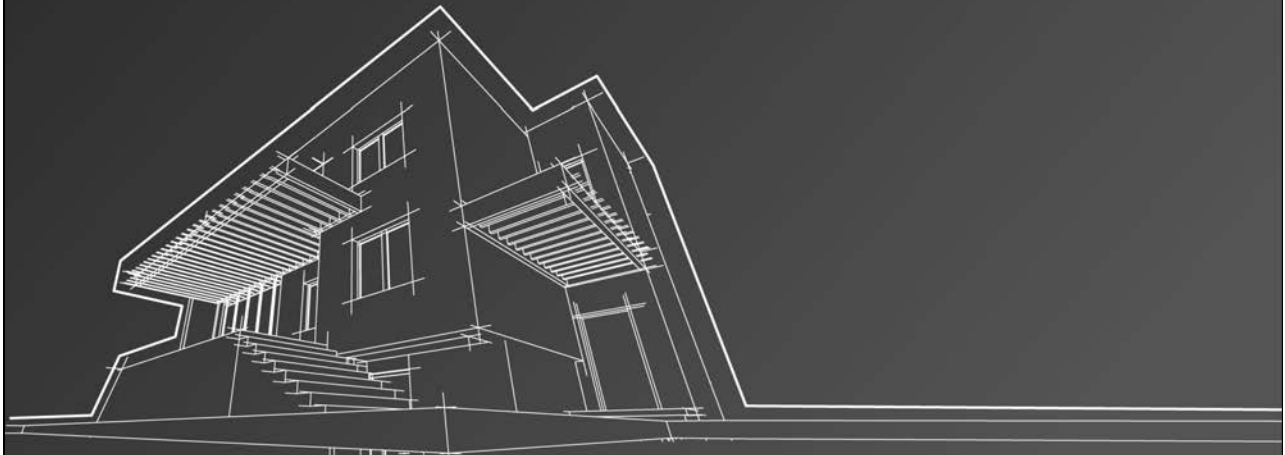

The Air Leakiness of OSB

Measuring air and moisture flow through building materials and assemblies

David W. Boyer & Tom Schneider

PROSOCO Building Envelope Innovations

