

Joseph Lstiburek, Ph.D., P.Eng, ASHRAE Fellow

Building Science

Made In Canada, Eh?

www.buildingscience.com

Actually, not really, we copied the wrong idea.

Actually, not really, we copied the wrong idea.
We should have copied the Canadian idea not the Danish idea.

Arkansas Project - USA - 1974
Harry Tschumi
Les Blades
Frank Holtzclaw

Lyngby House - Denmark - 1975



Lyngby House - Denmark – 1975
Van Korsgaard – Technical University of
Denmark
R-40 walls, R-60 roof
Air to air heat exchanger
Double walls
Double glazed windows with insulating shutters
Solar thermal – 8,000 gal storage tank

Lo Cal House - USA - 1976



Lo Cal House - USA – 1976
Wayne Shick and Bud Konzo
R-30 double stud walls
R-30 vented roof
Triple glazed windows
Air to air heat exchanger

Double Wall Patented in US - 1976
Richard Bentley patent discusses
airtightness and air-to-air heat exchangers

Saskatchewan Conservation House - 1977



Saskatchewan Conservation House – 1977
R-40 double stud walls
R-60 ceiling
Triple glazed windows
Air to air heat exchanger
0.8 ach@50 Pa

Leger House - USA - 1977



Parade of Homes - Saskatoon - 1980

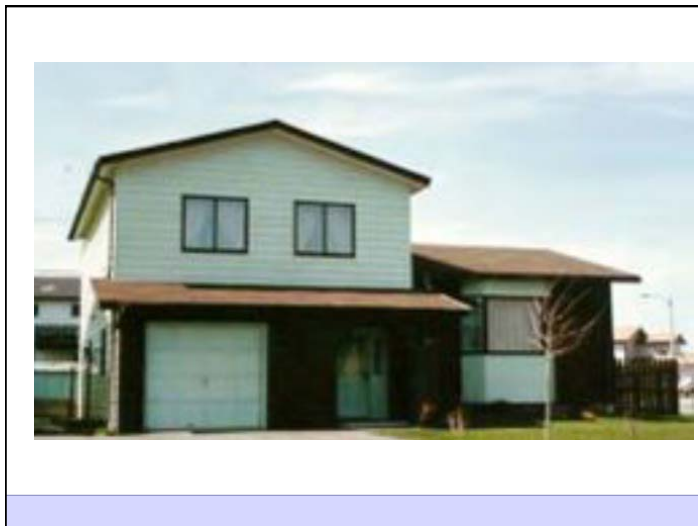

Buffalo Homes - Montana - 1985



Dumont House - Saskatoon - 1990

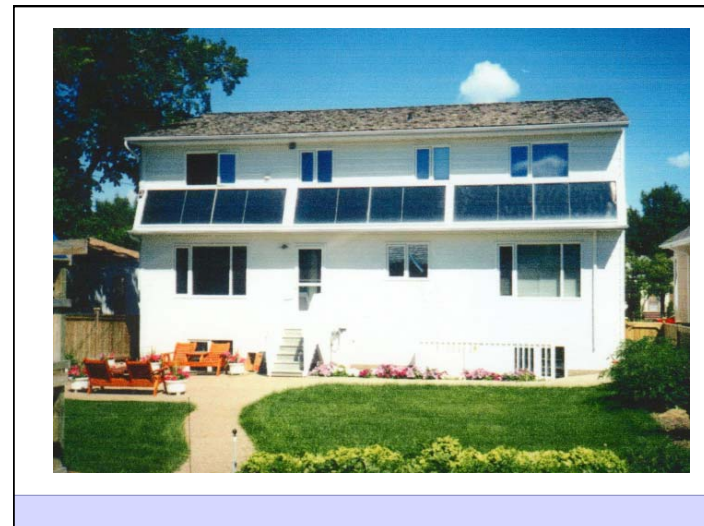

Another point of view.....

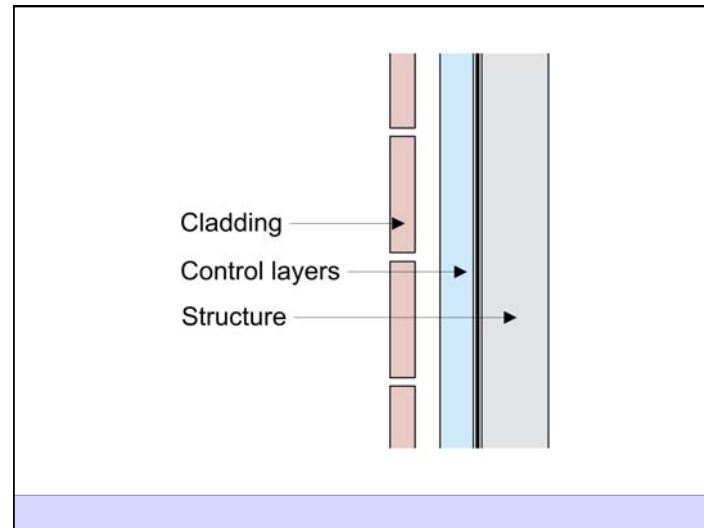
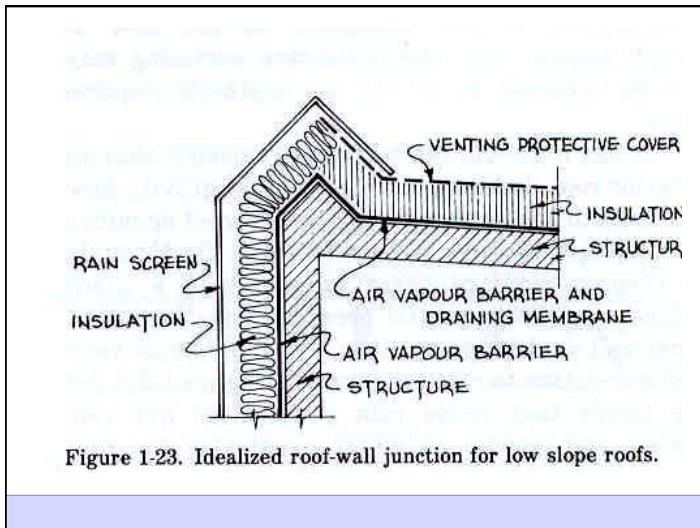
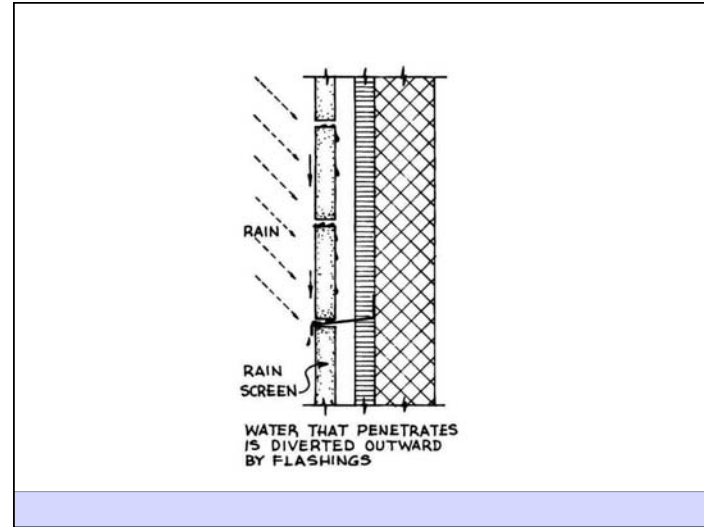

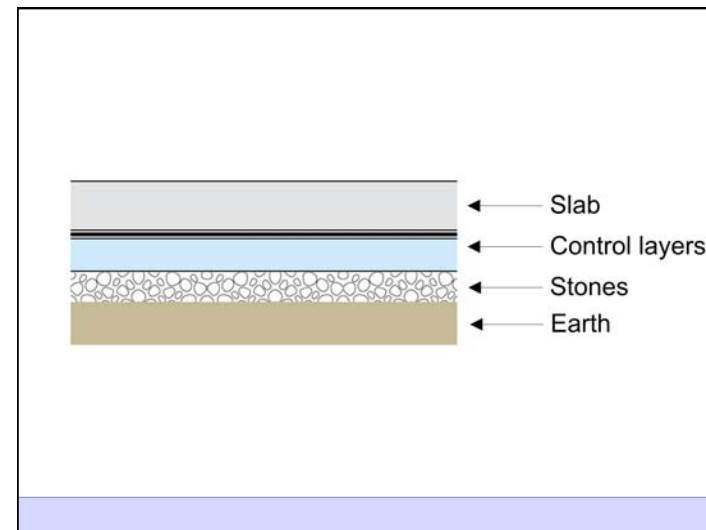
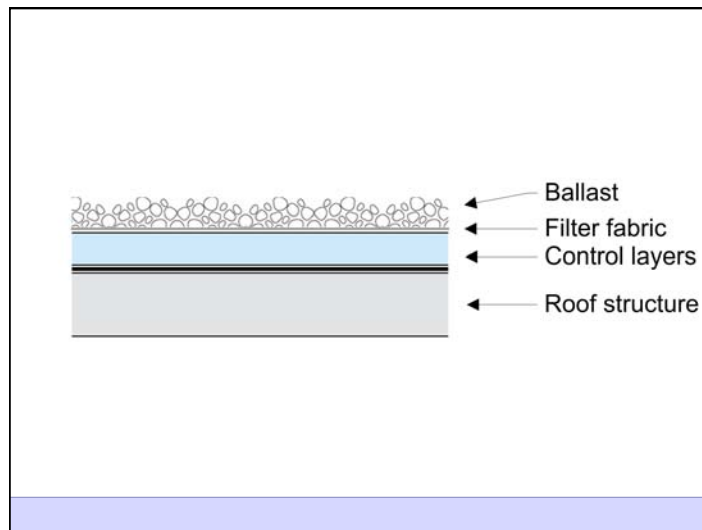
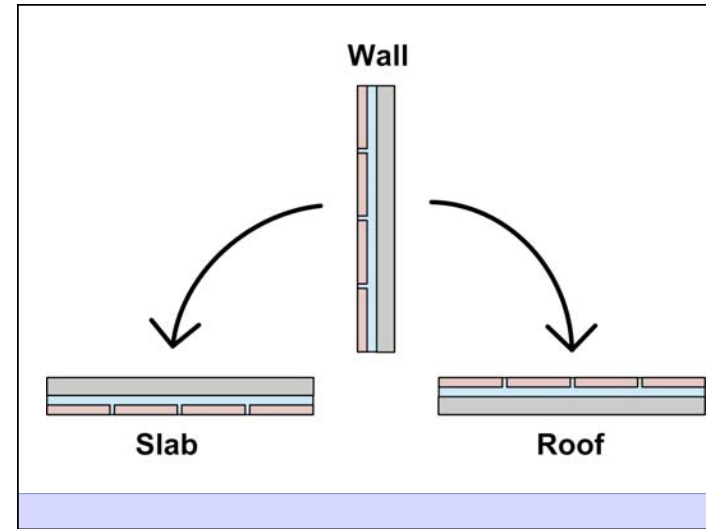
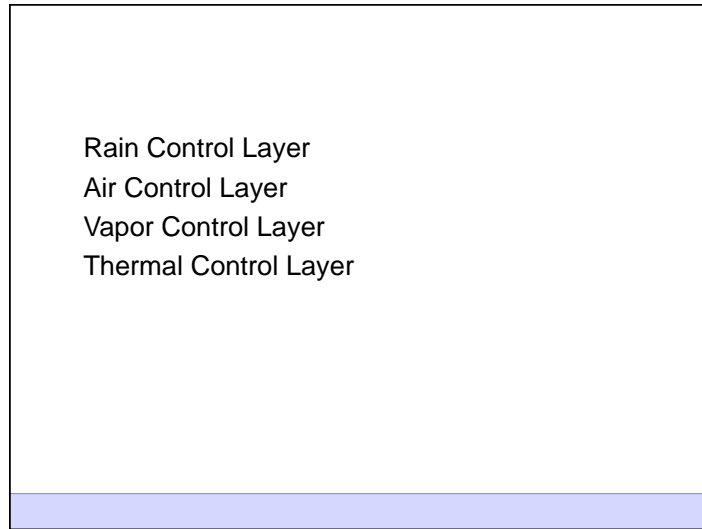

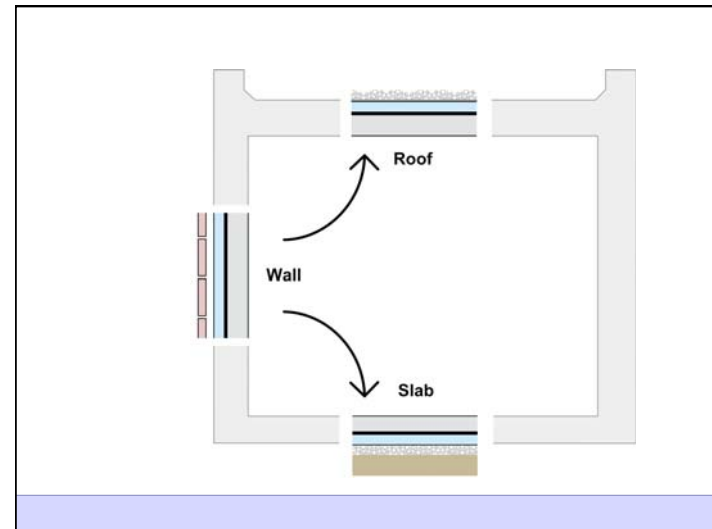
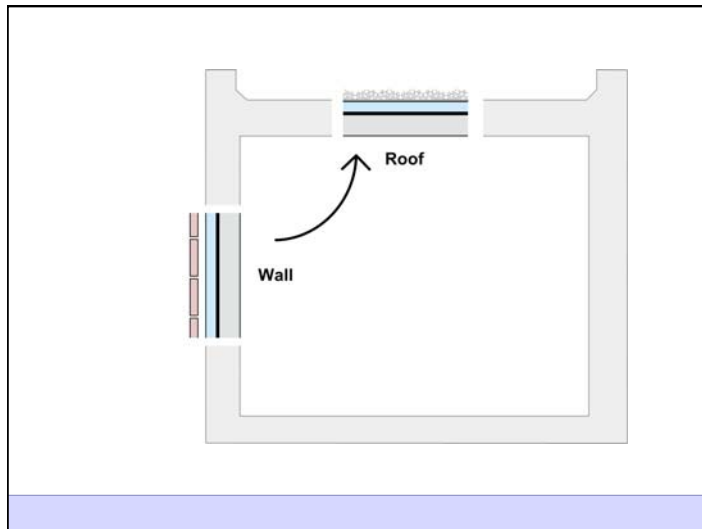
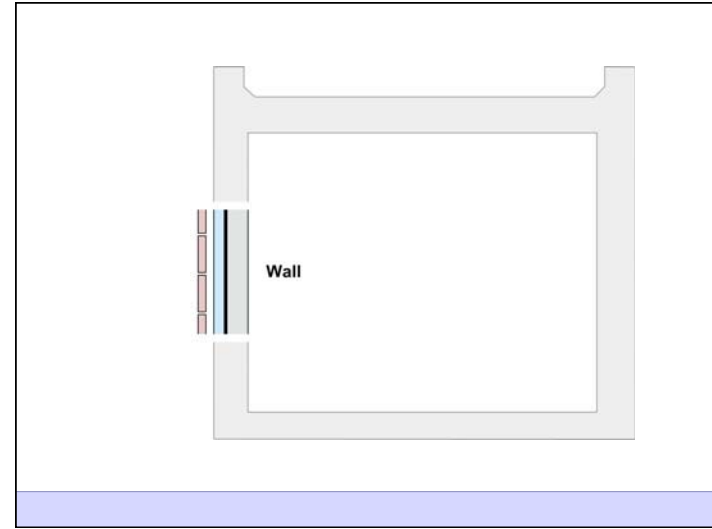
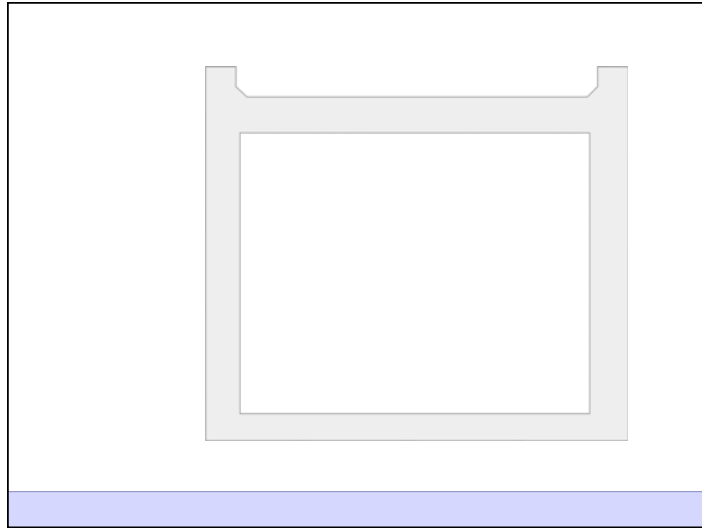

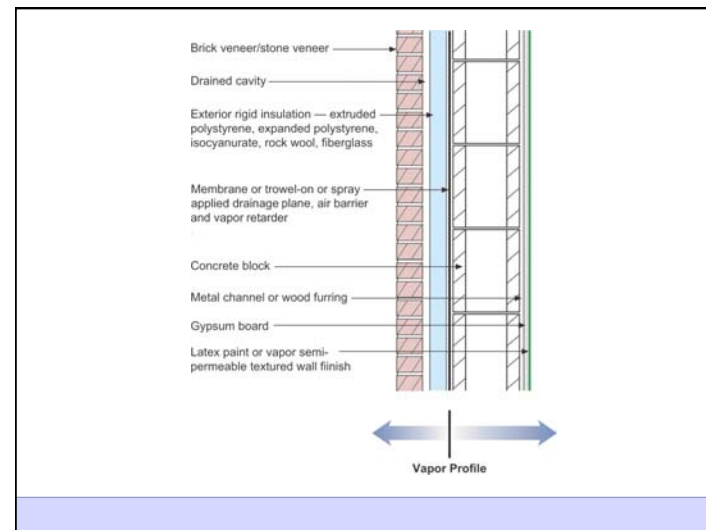
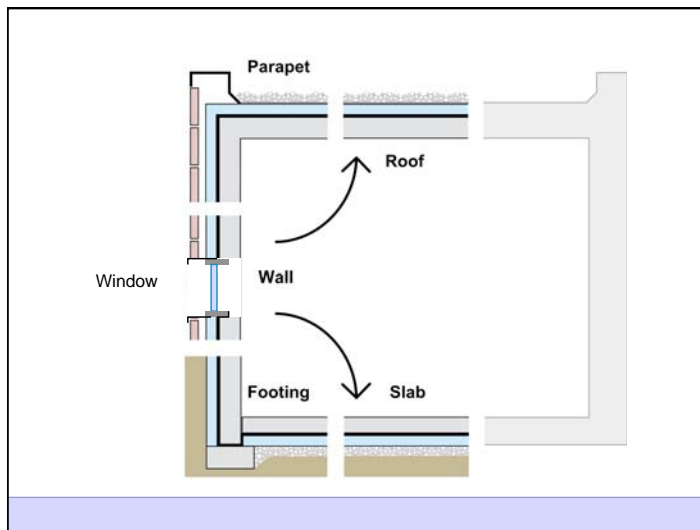
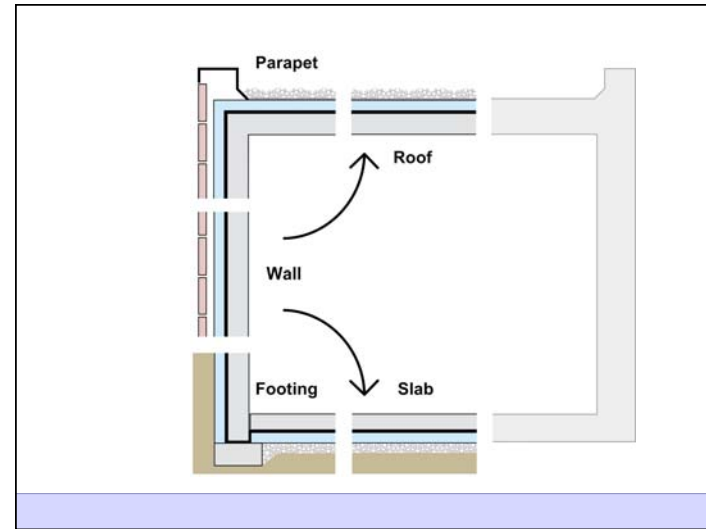
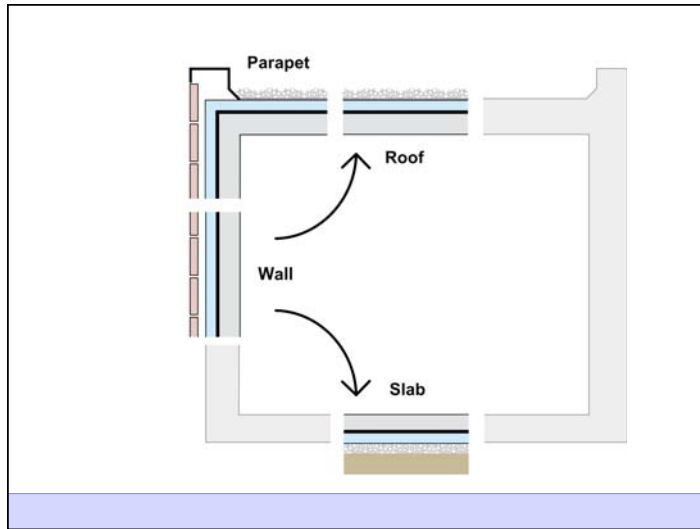

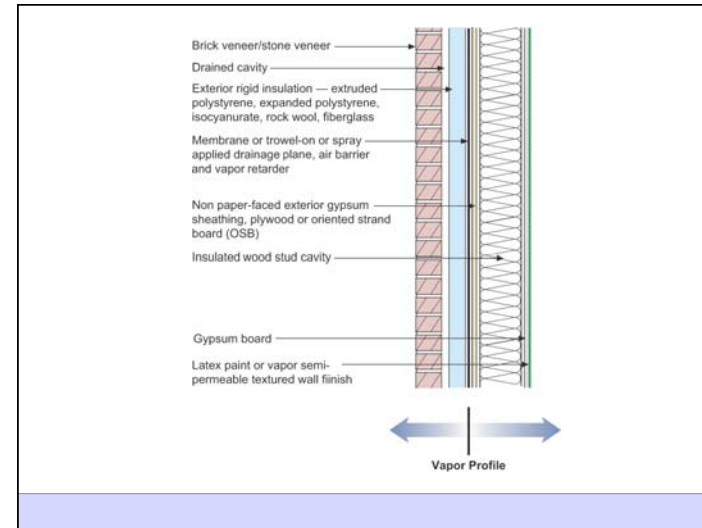
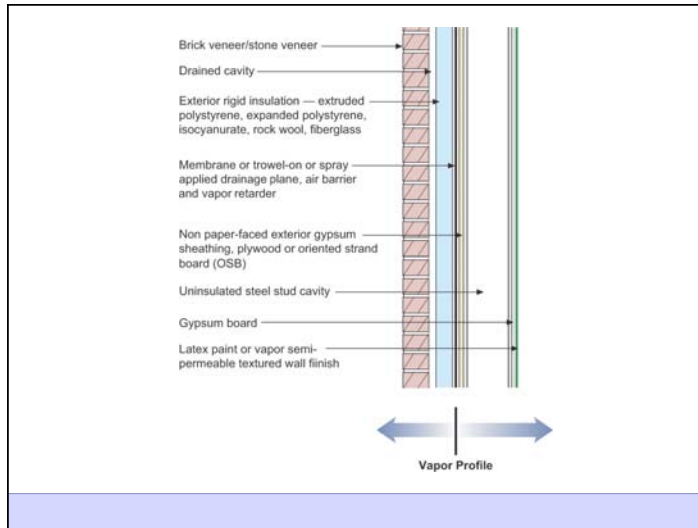

How I Spent 1979, 1980 and 1981

Carnarvon

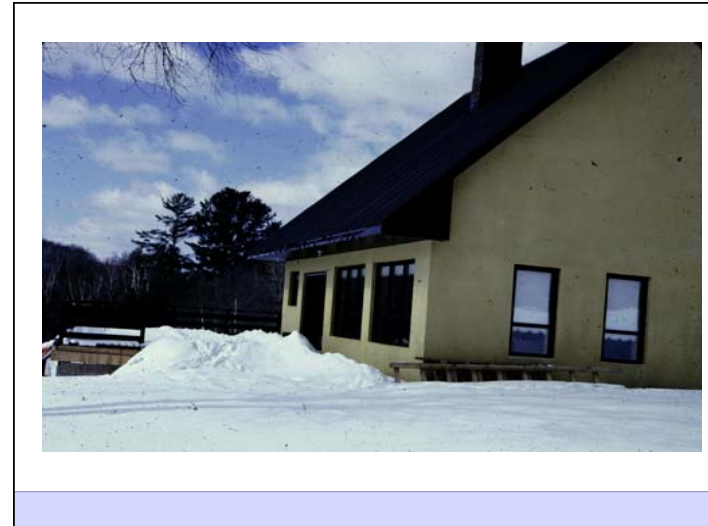

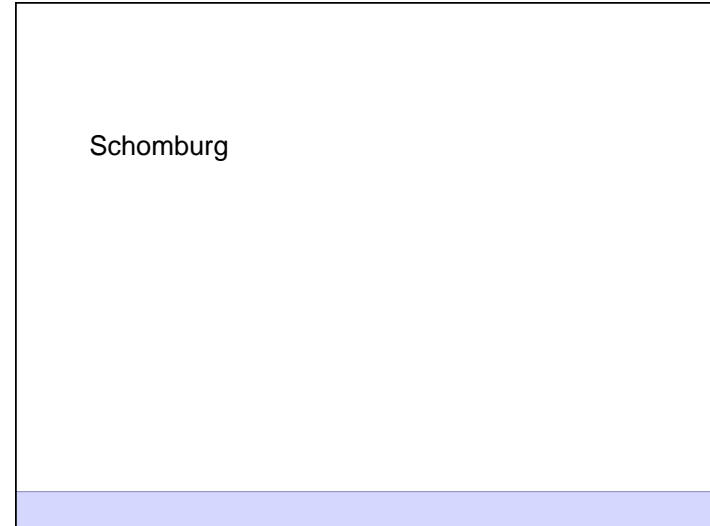

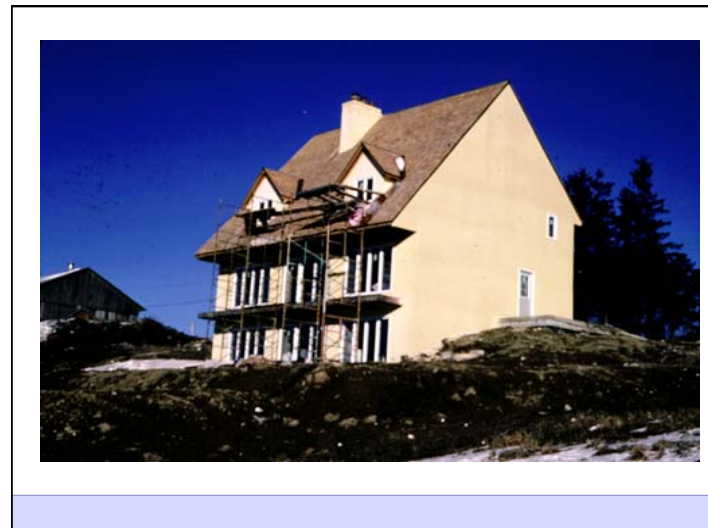
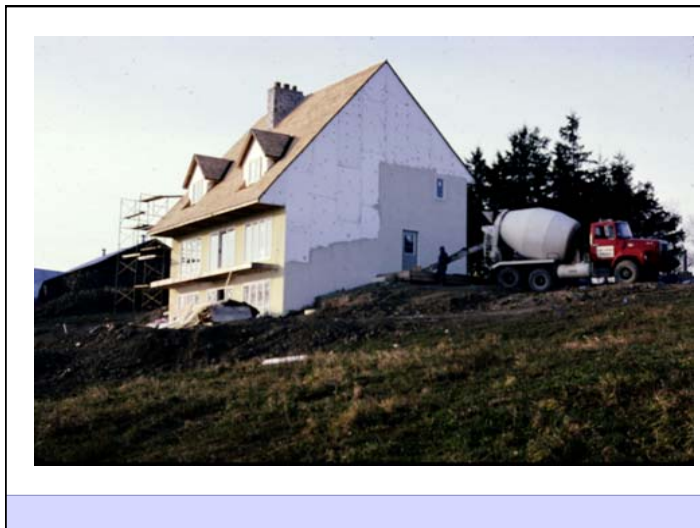
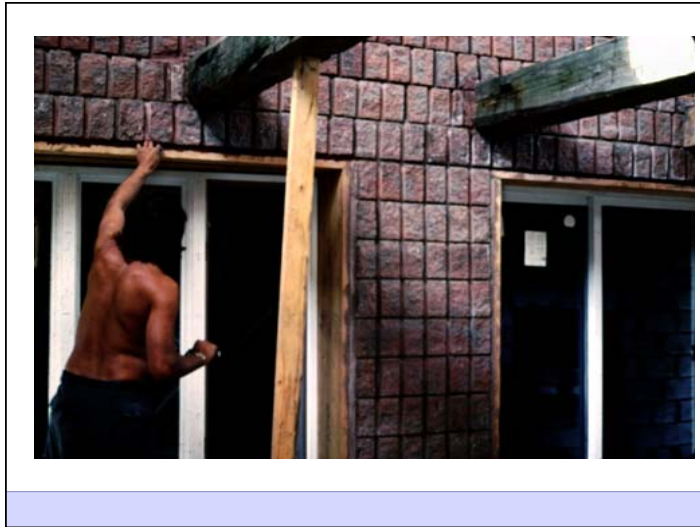

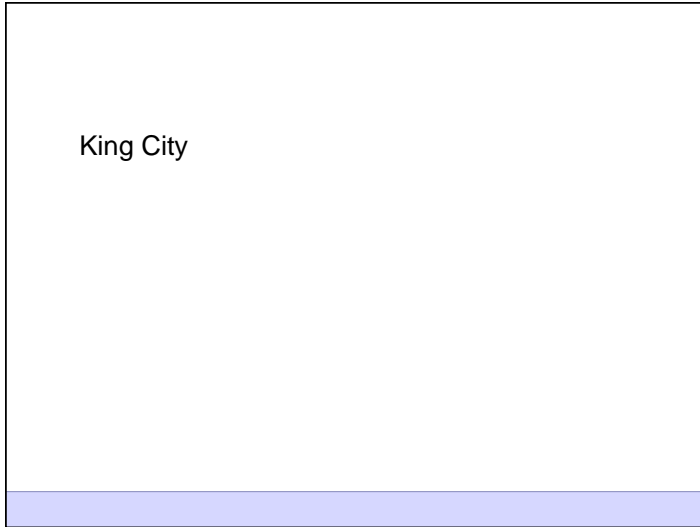

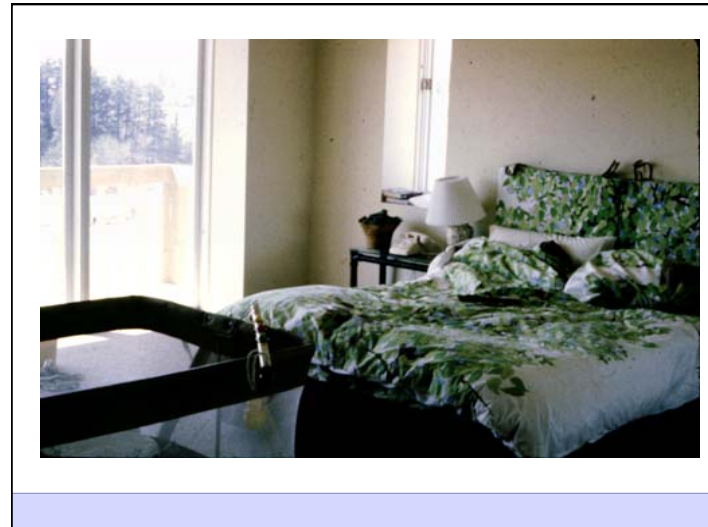
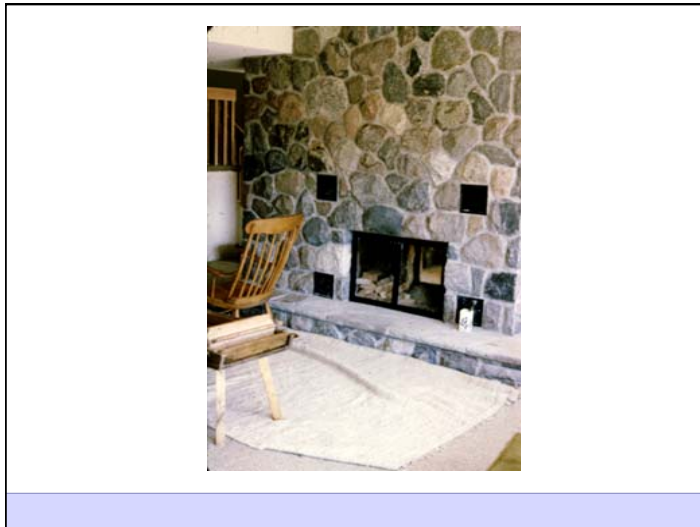
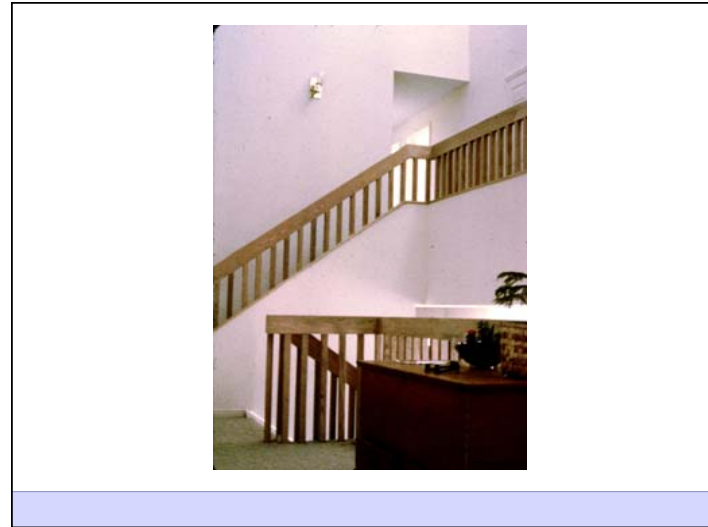

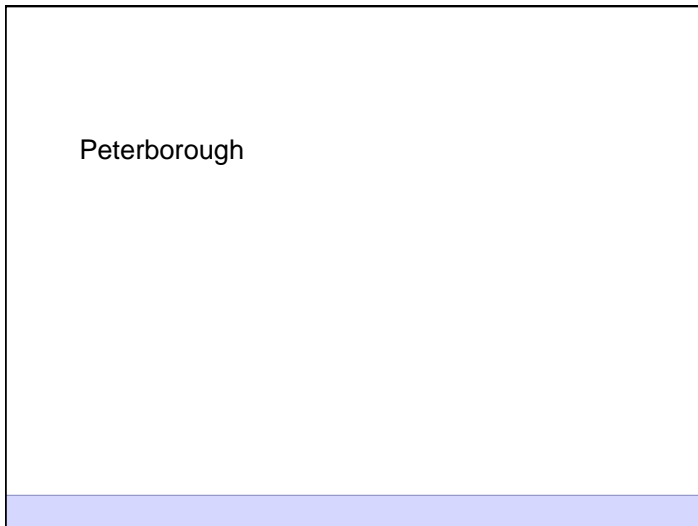





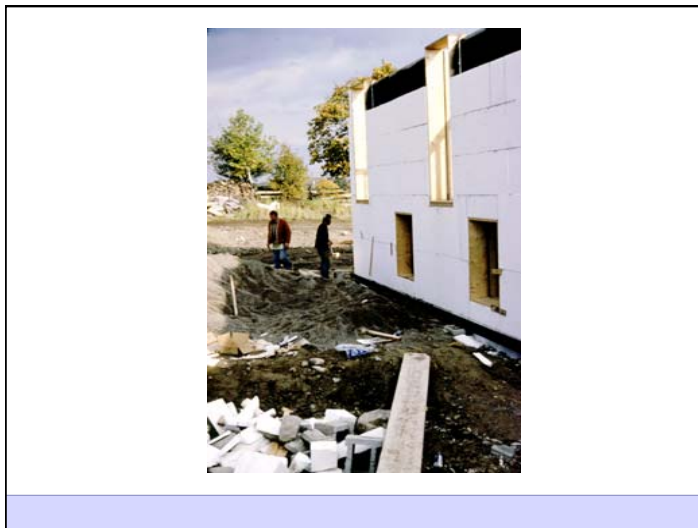

Collingwood

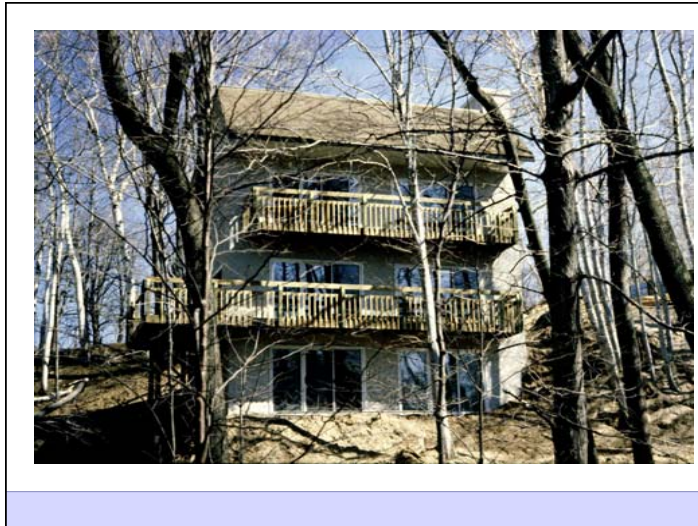

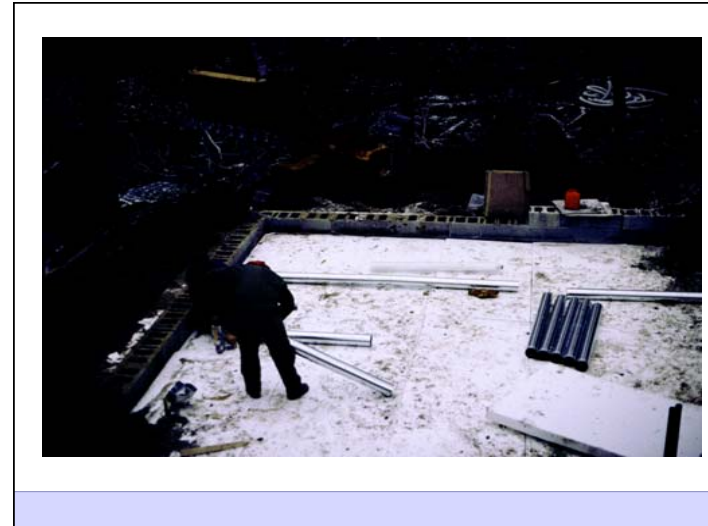
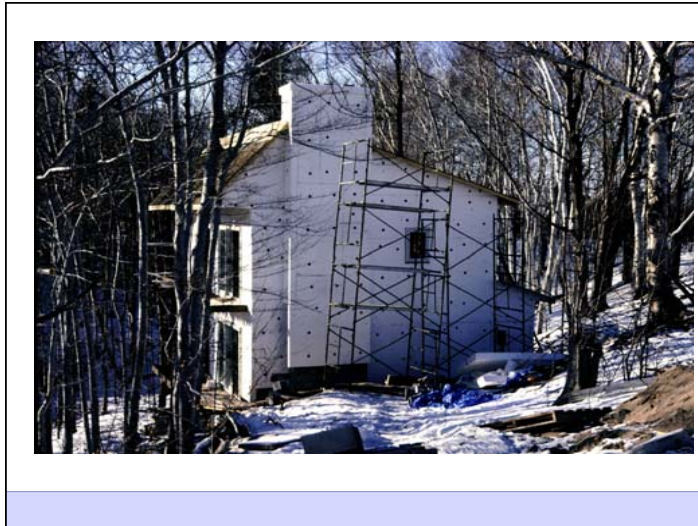

Newmarket









Liverpool, NS

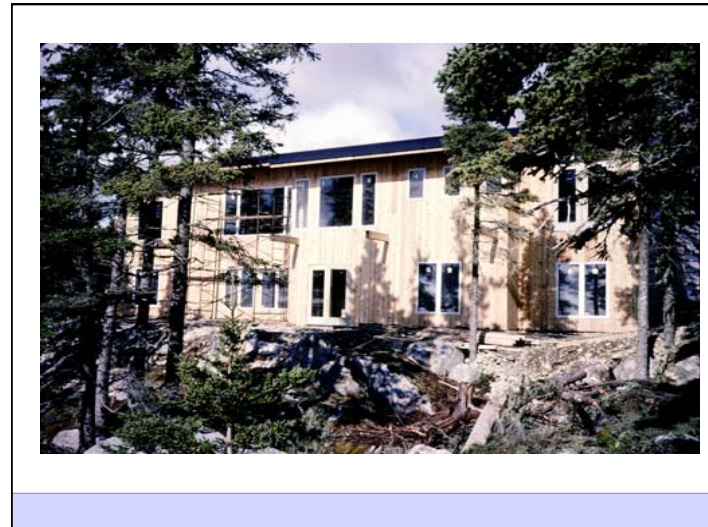
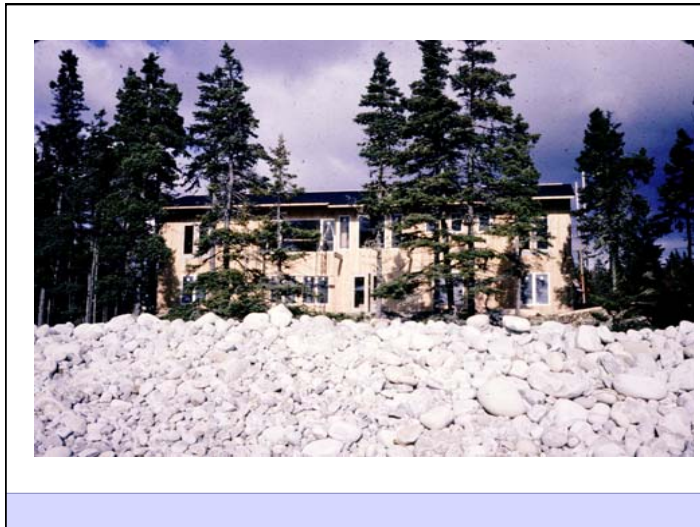



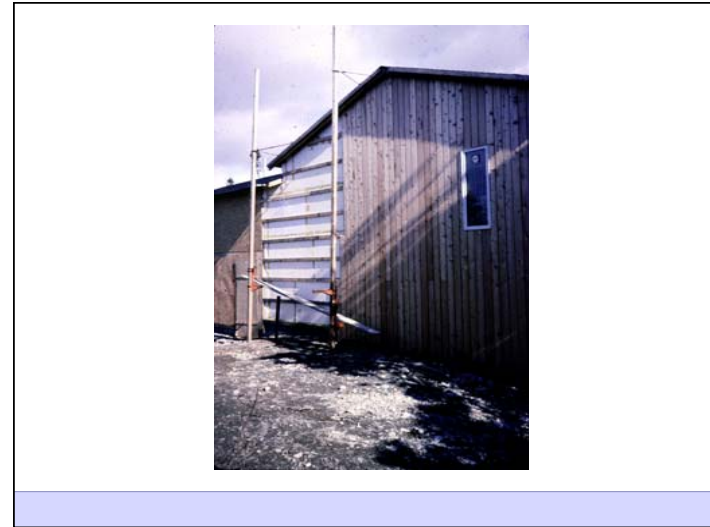

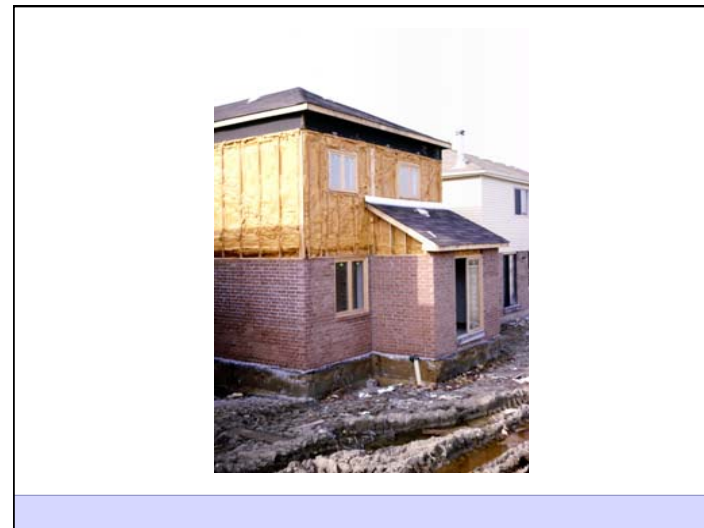
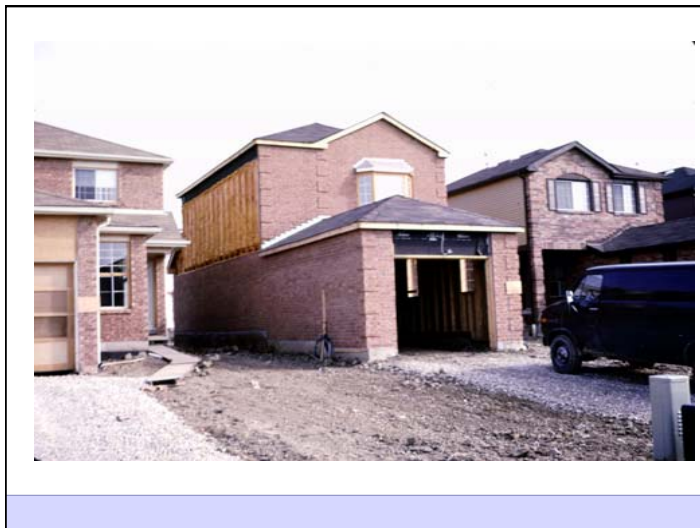

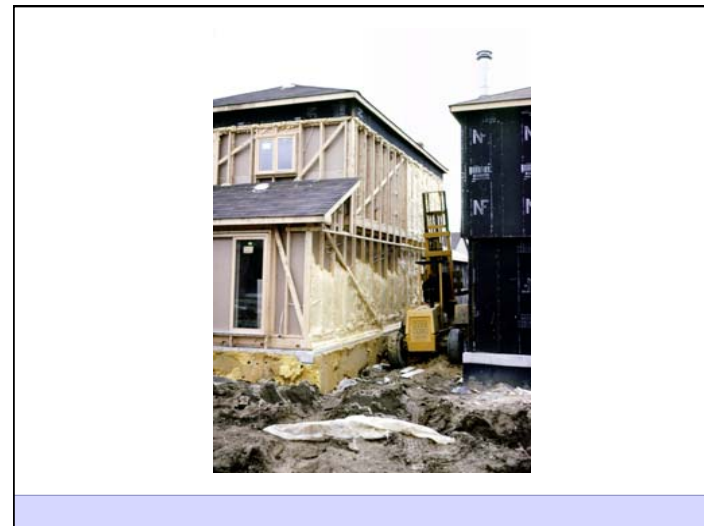
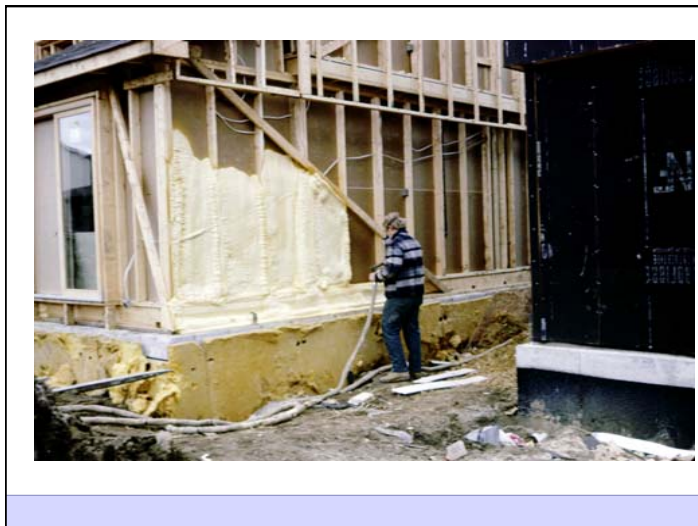

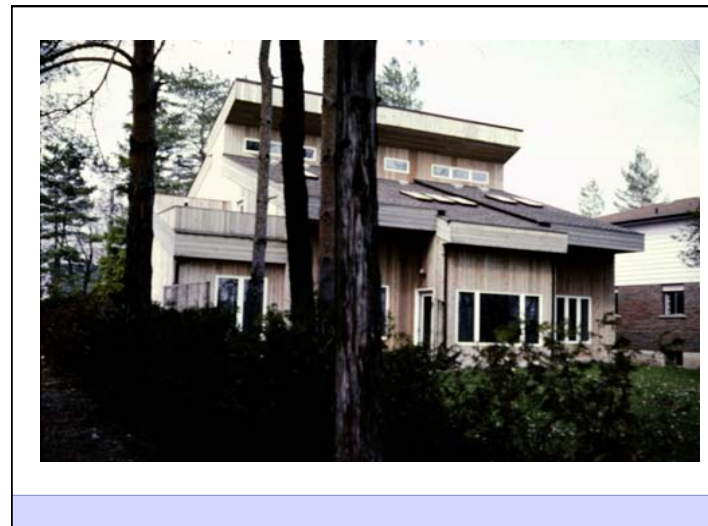
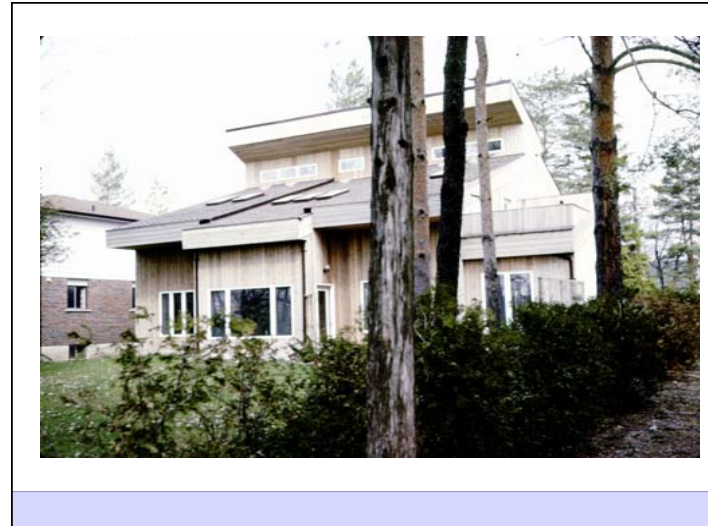
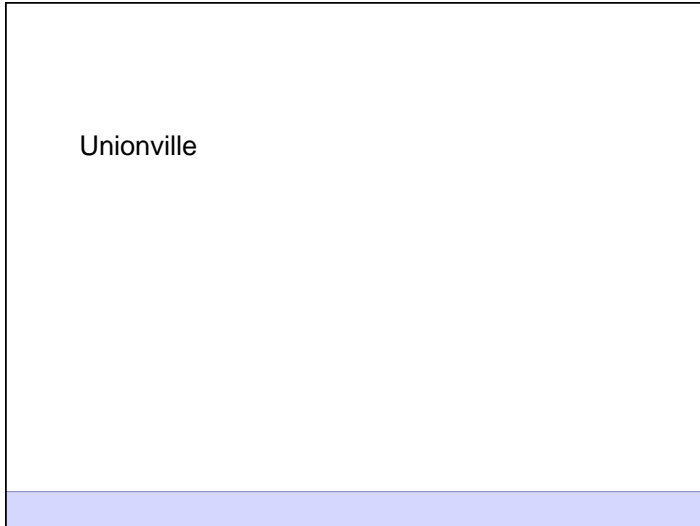

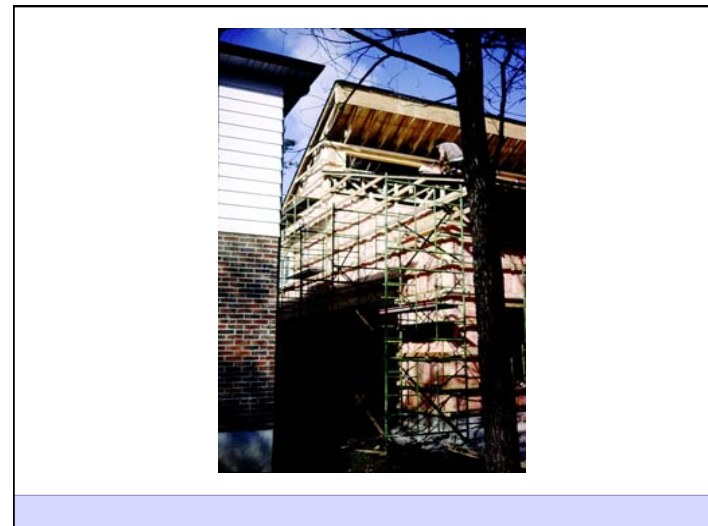
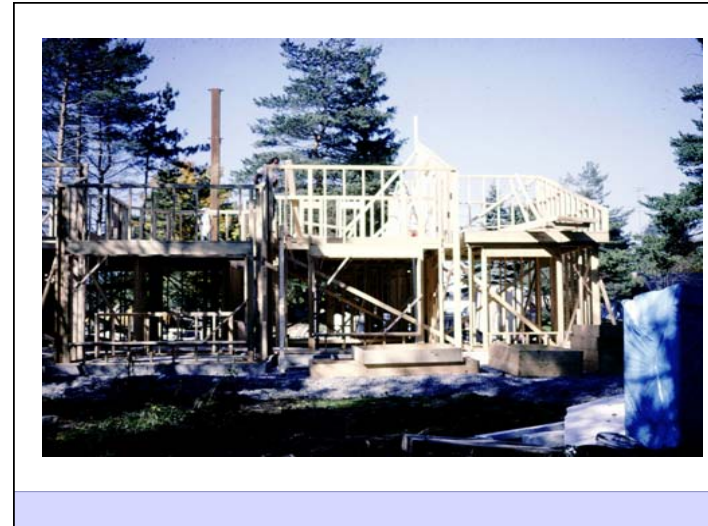

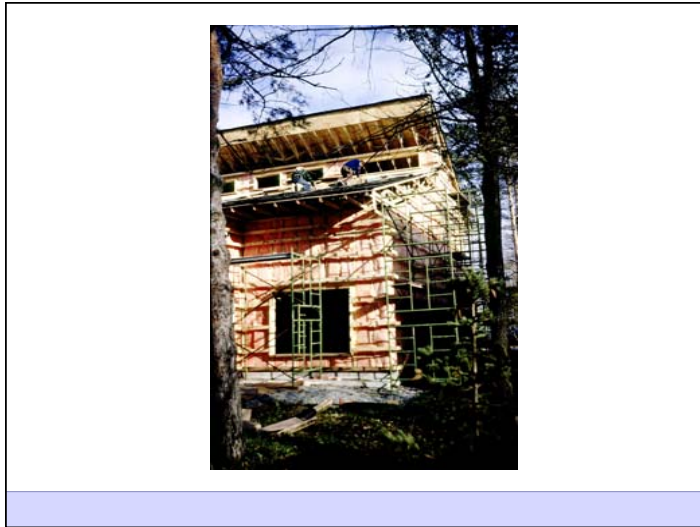

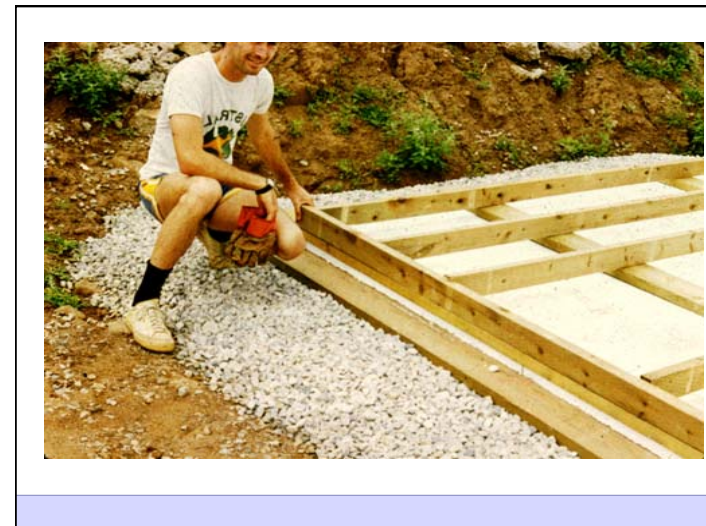
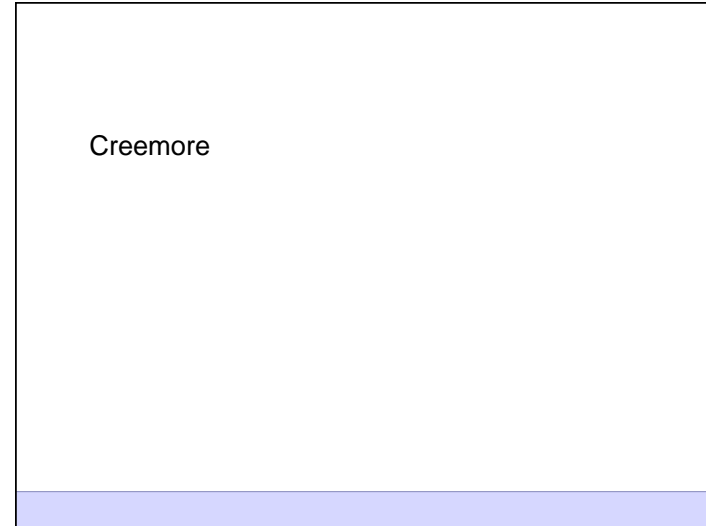

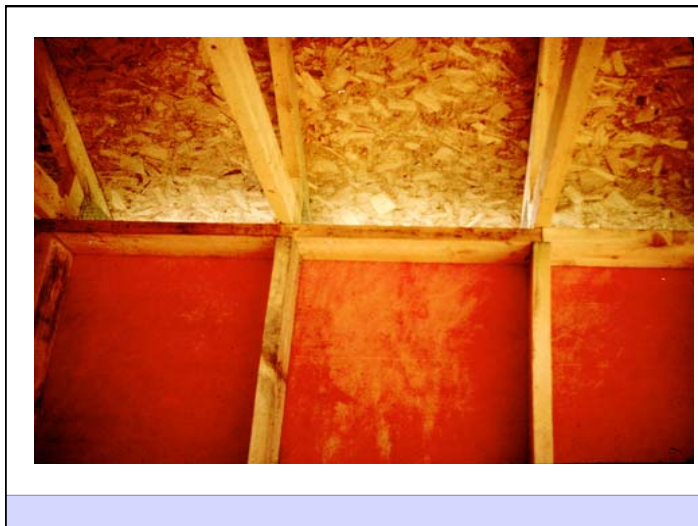

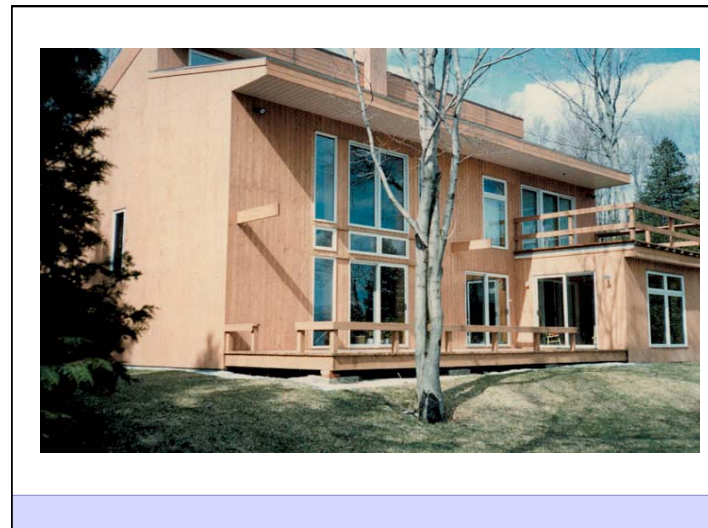
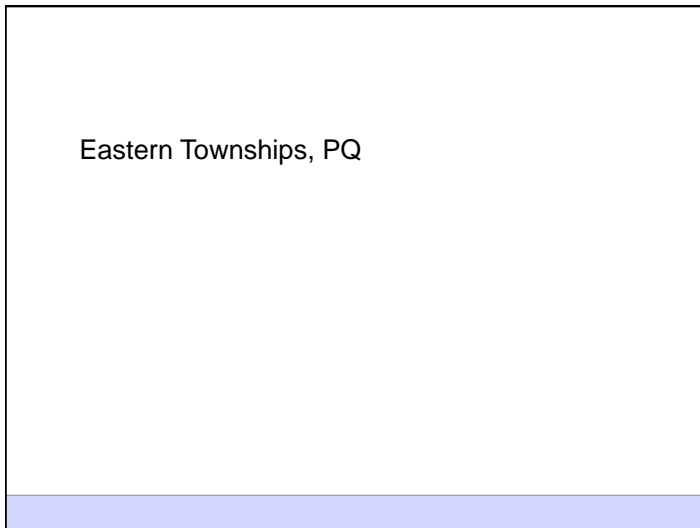
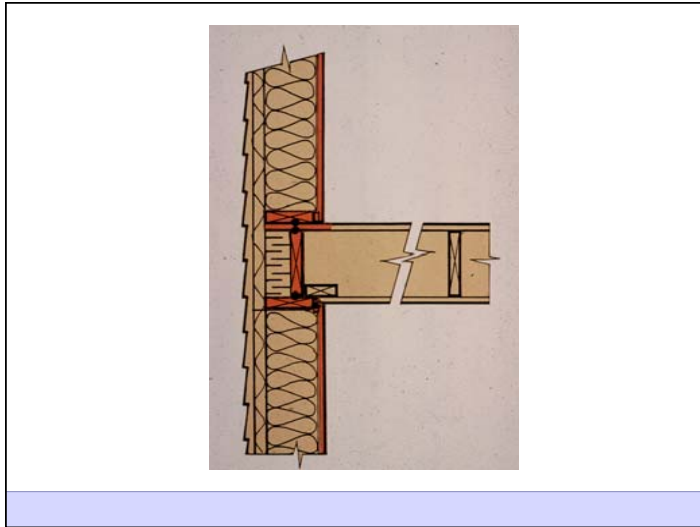

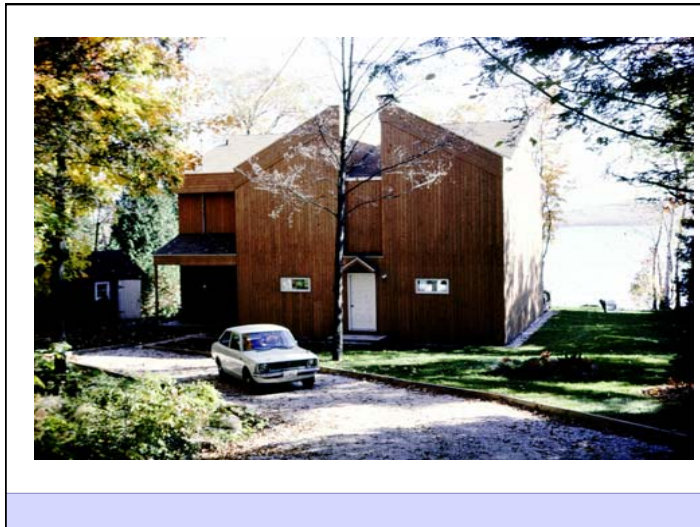
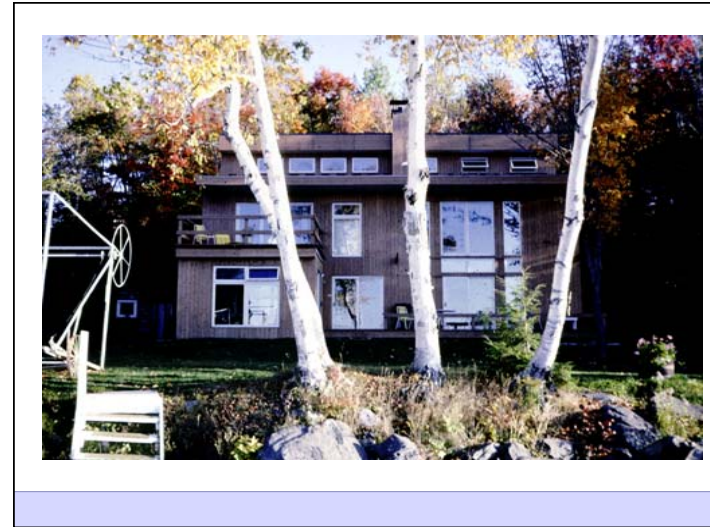
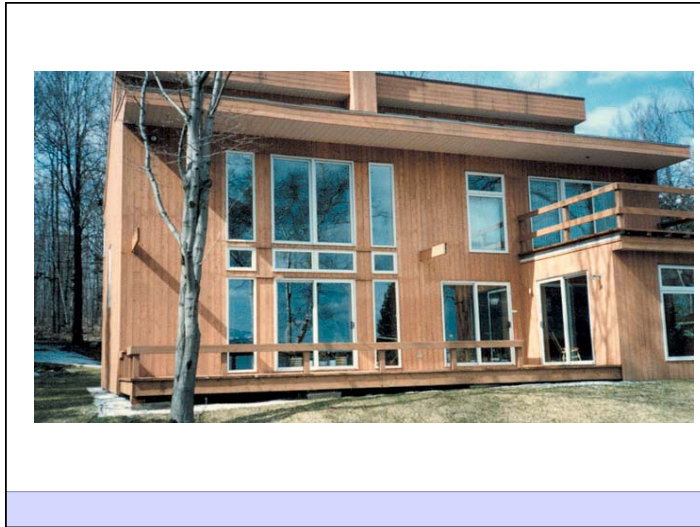



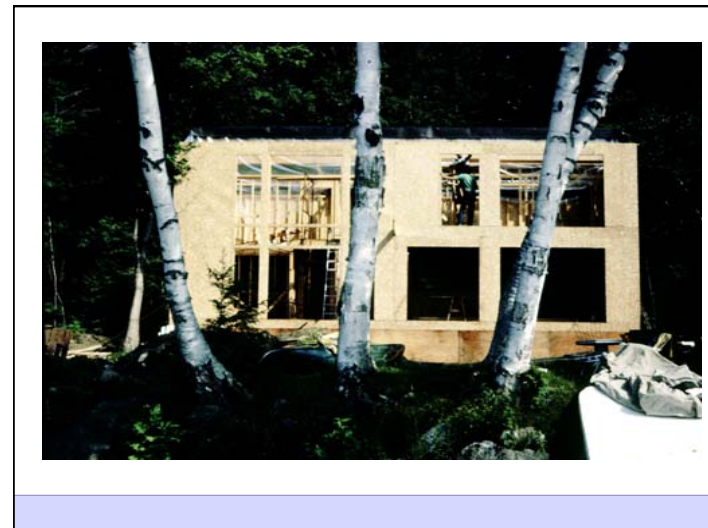

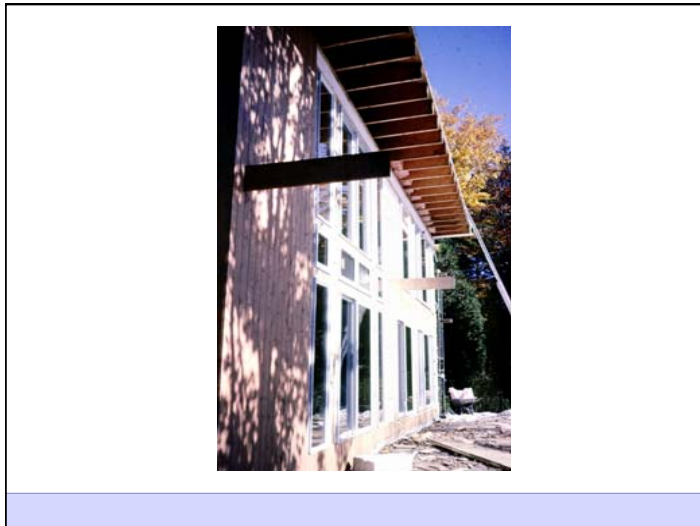



Twenty Five Years Later.....

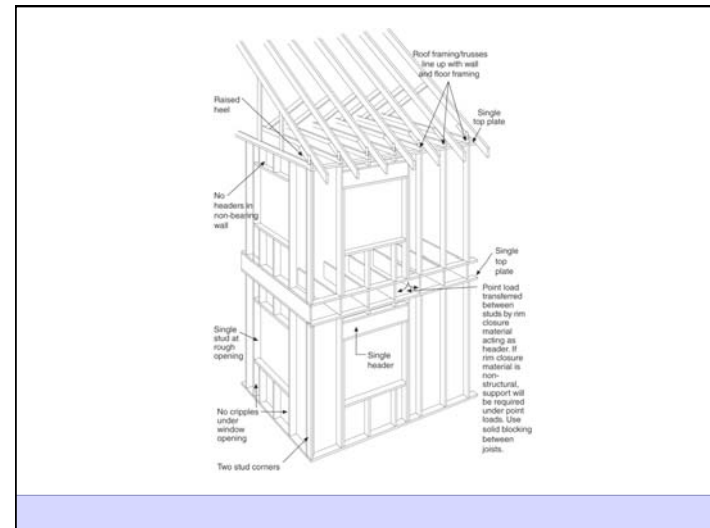
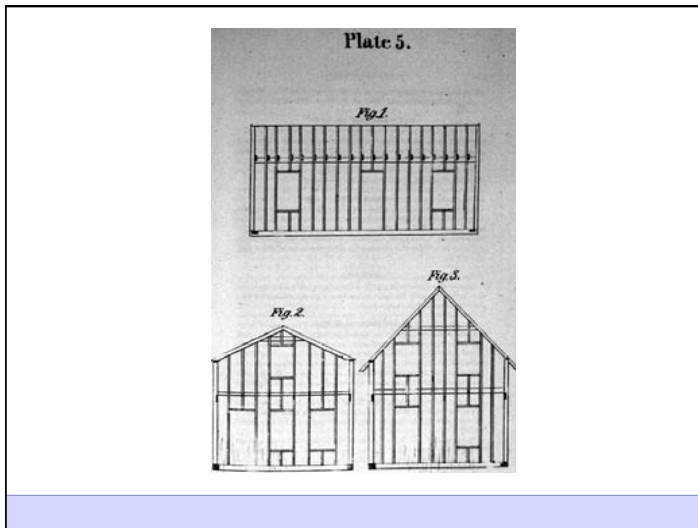



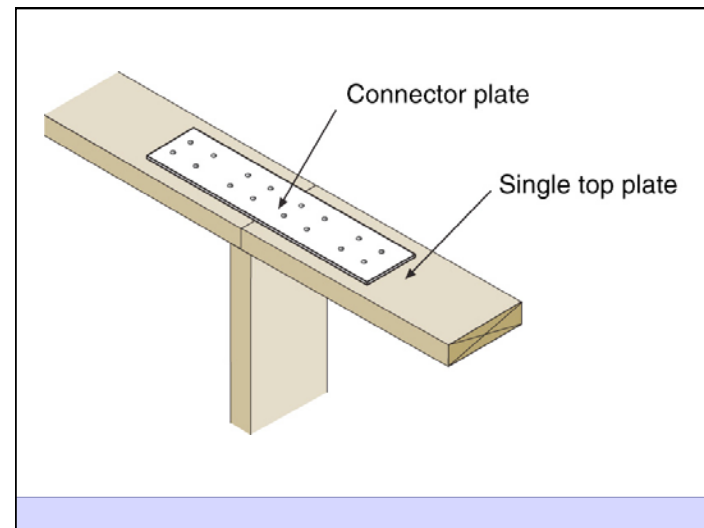
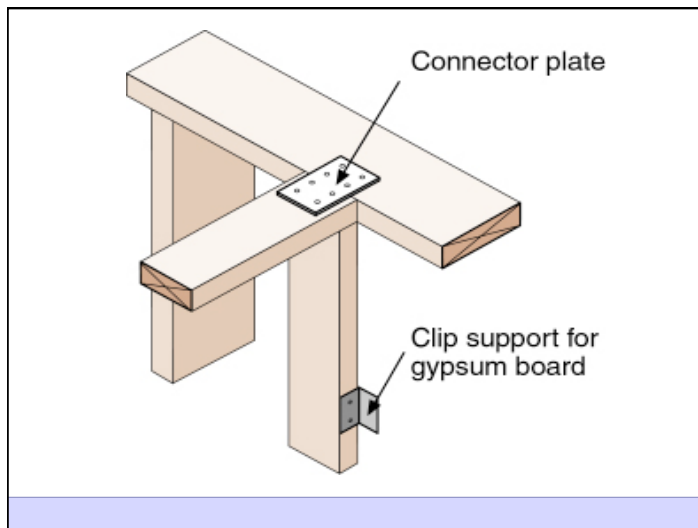
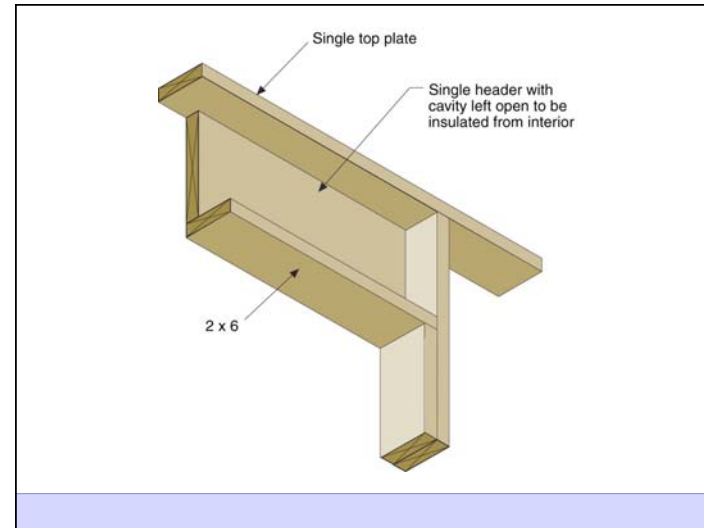

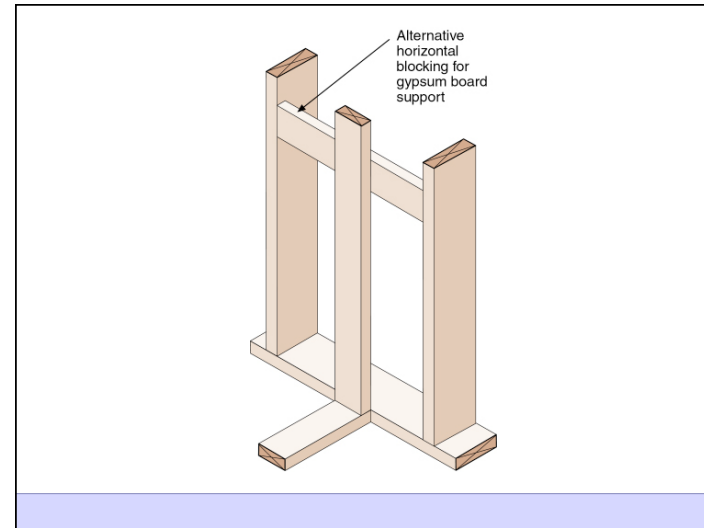
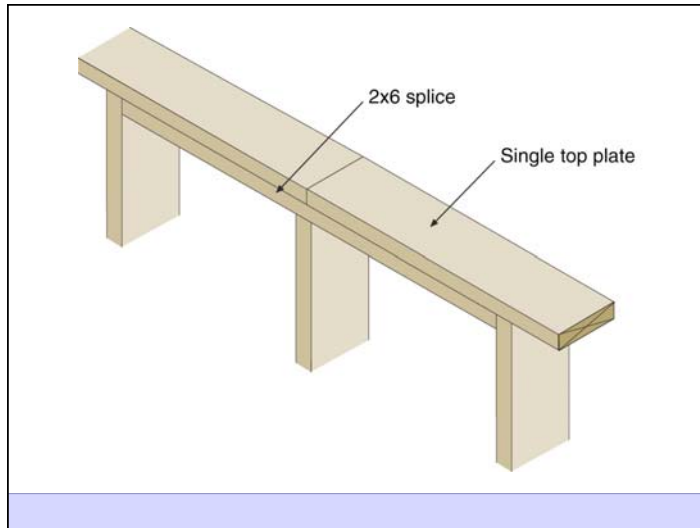



Westford House.....



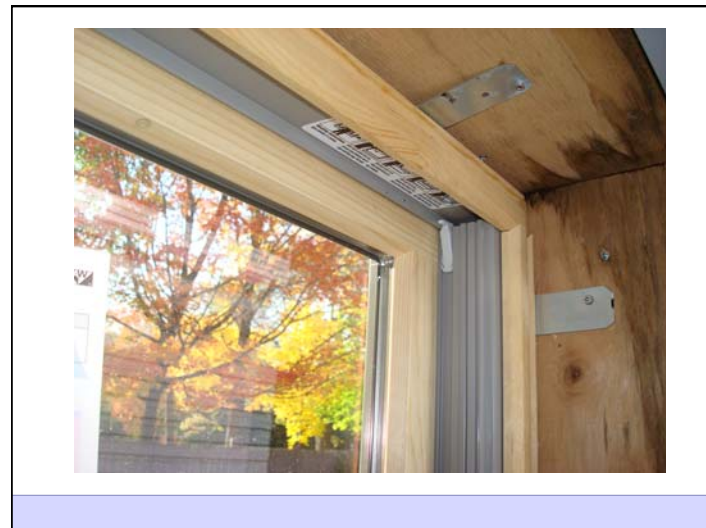
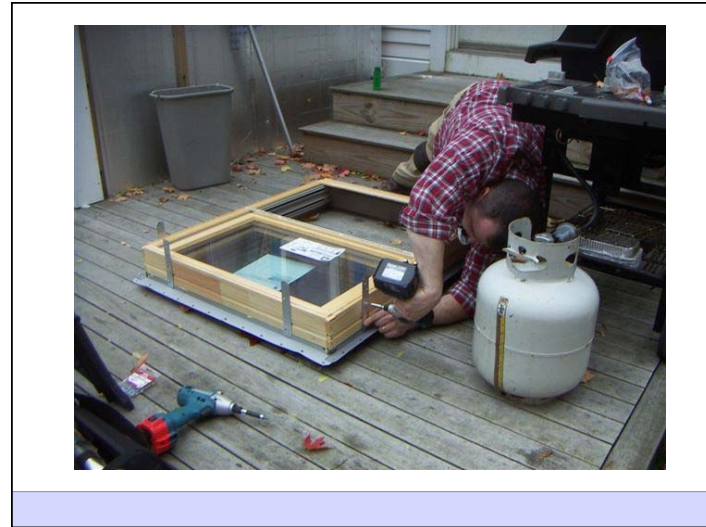





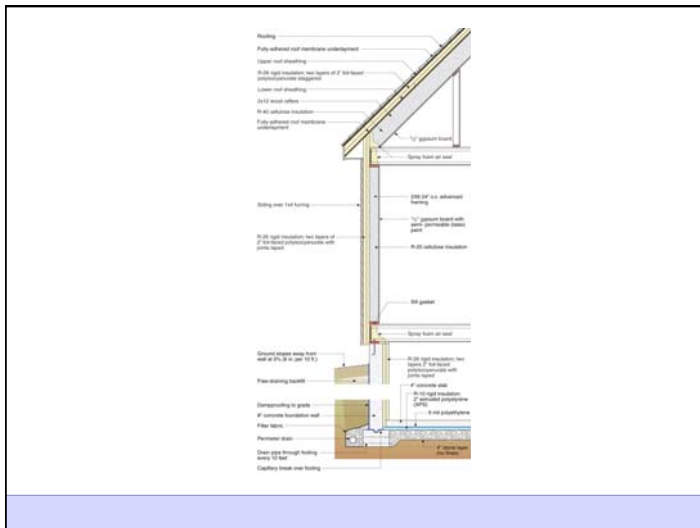
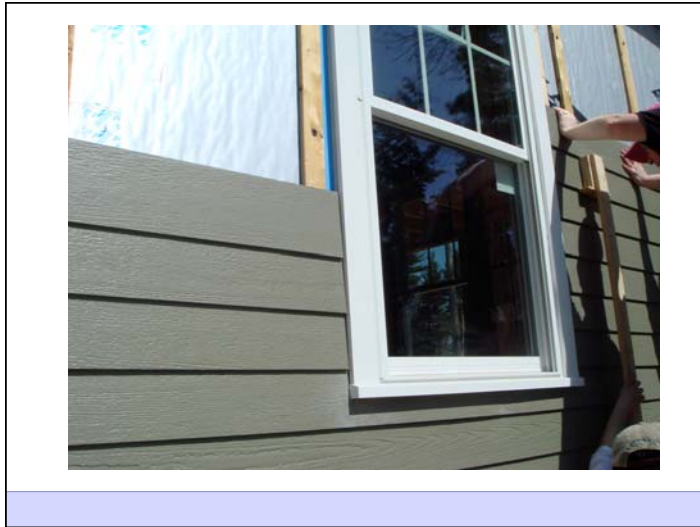

Net Zero Retrofit.....

