

Joseph Lstiburek, Ph.D., P.Eng, ASHRAE Fellow

Building Science

Adventures In Building Science

www.buildingscience.com



Building Science Corporation

Joseph Lstiburek – Rain Control 2



Building Science

Joseph Lstiburek 3



Building Science

Joseph Lstiburek 4



Building Science

Joseph Lstiburek 5



Building Science

Joseph Lstiburek 6



Building Science

Joseph Lstiburek 7



Building Science

Joseph Lstiburek 8

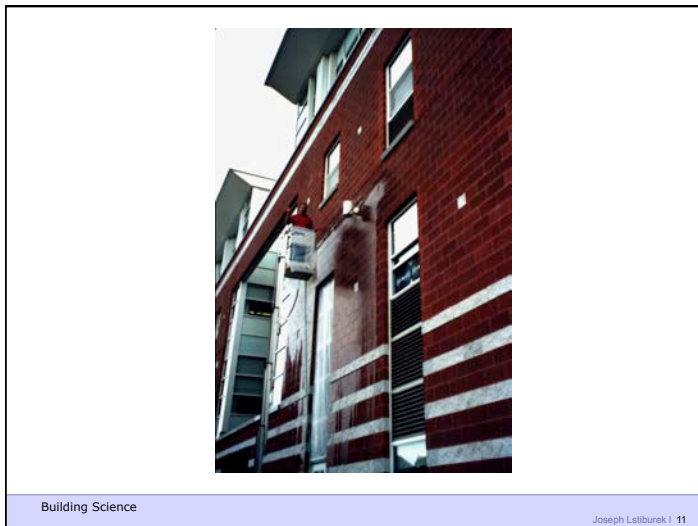
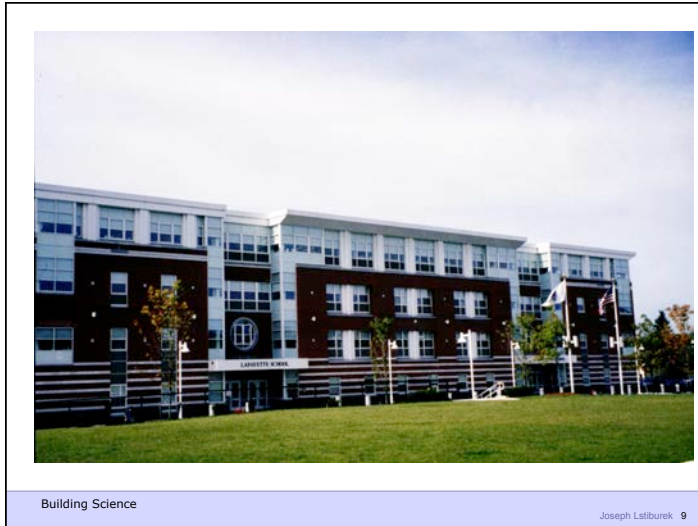

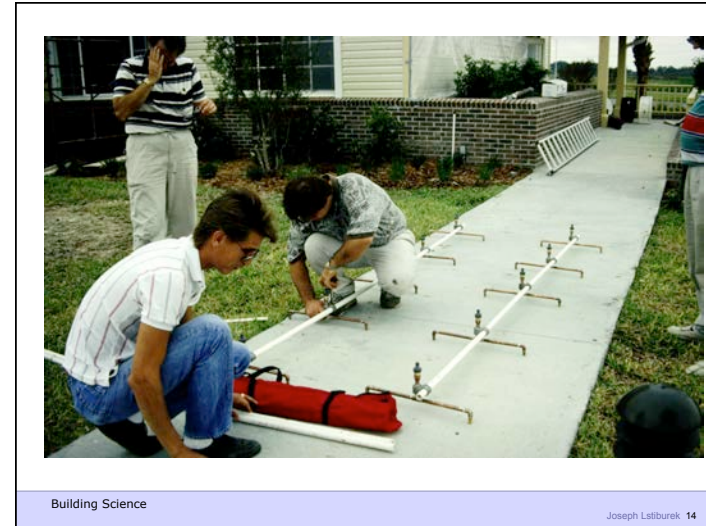

Damage Functions

Building Science Corporation Joseph Lstiburek 17

Damage Functions
Water
Heat
Ultra Violet Radiation

Building Science Corporation Joseph Lstiburek 18

The Three Biggest Problems In Buildings Are
Water, Water and Water...

Building Science Corporation Joseph Lstiburek 19

80 Percent of all Construction Problems are
Related to Water

Building Science Corporation Joseph Lstiburek 20

Most Are Related to Rainwater

Building Science Corporation Joseph Lstiburek 21

Rain	Gravitational Flow Surface Tension Momentum Convective Flow	Height Surface Energy Kinetic Energy Air Pressure
------	--	--

Building Science Corporation Joseph Lstiburek 22

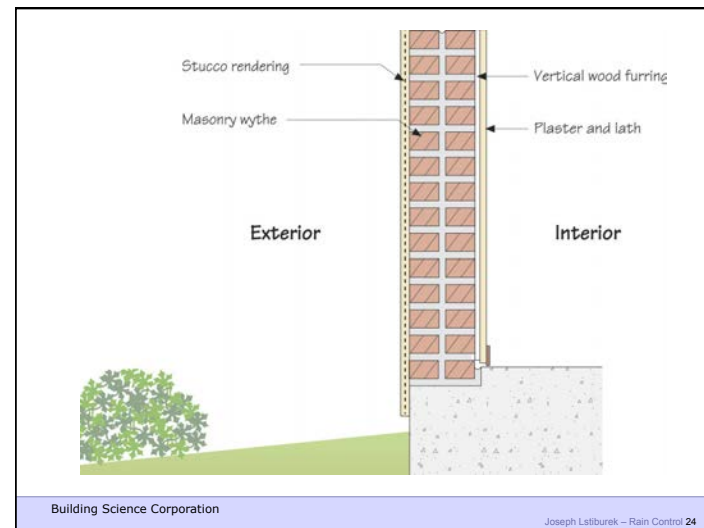
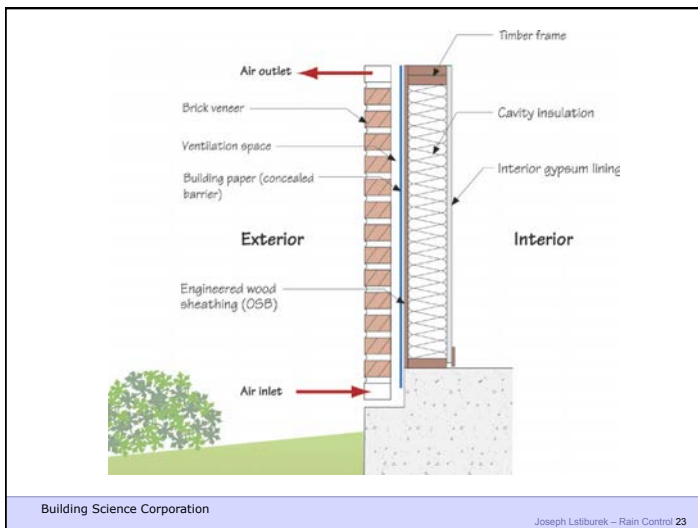

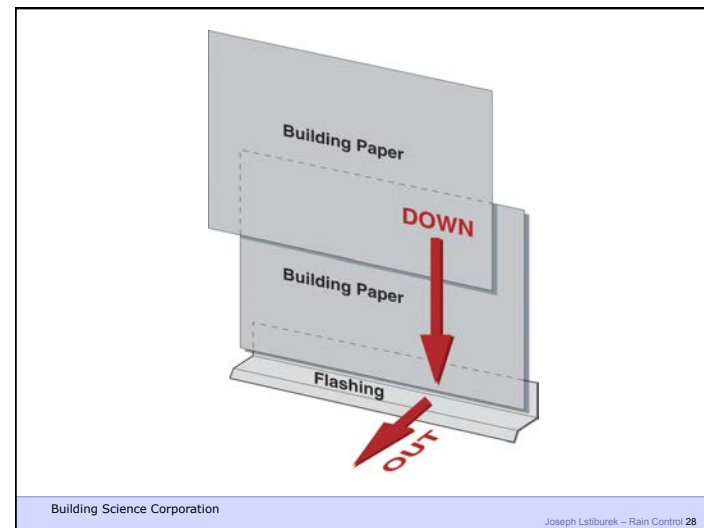
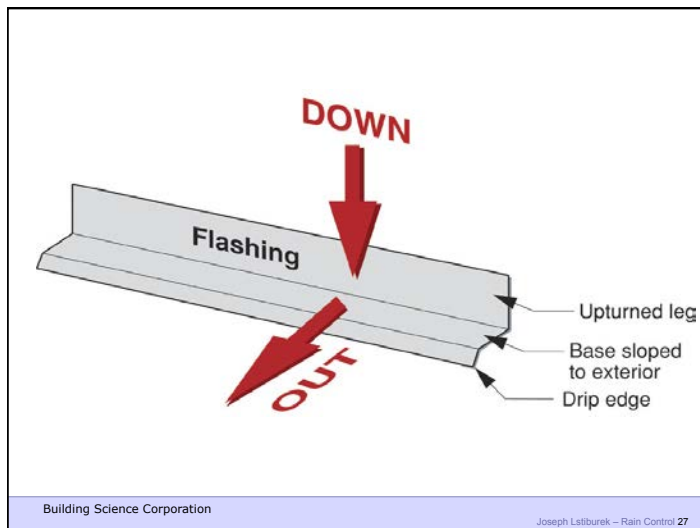

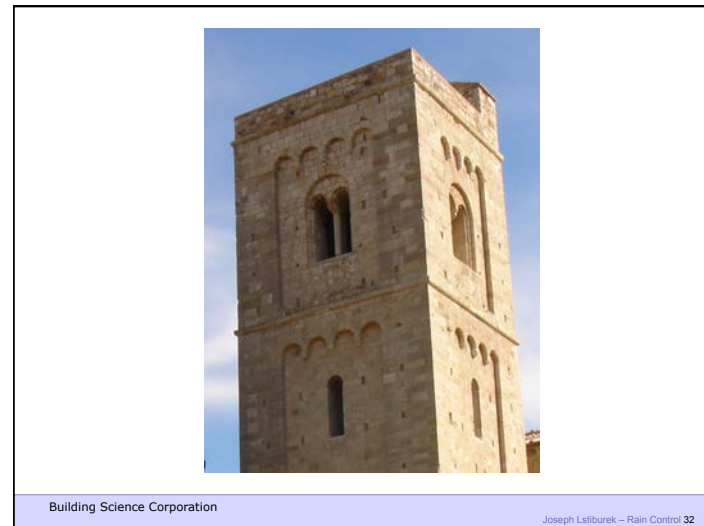
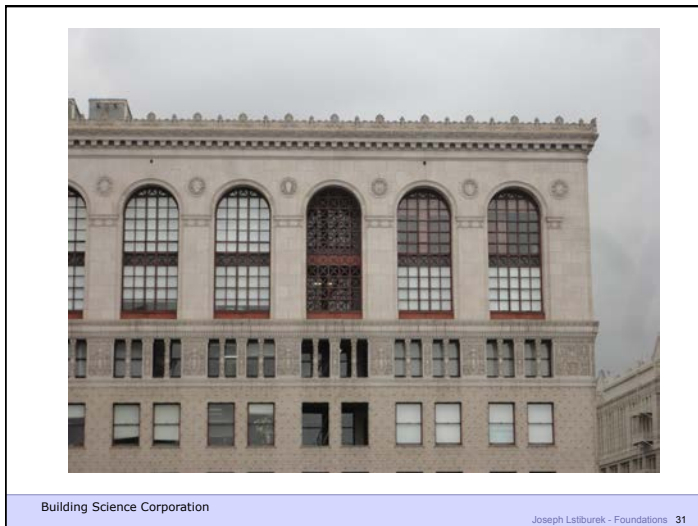
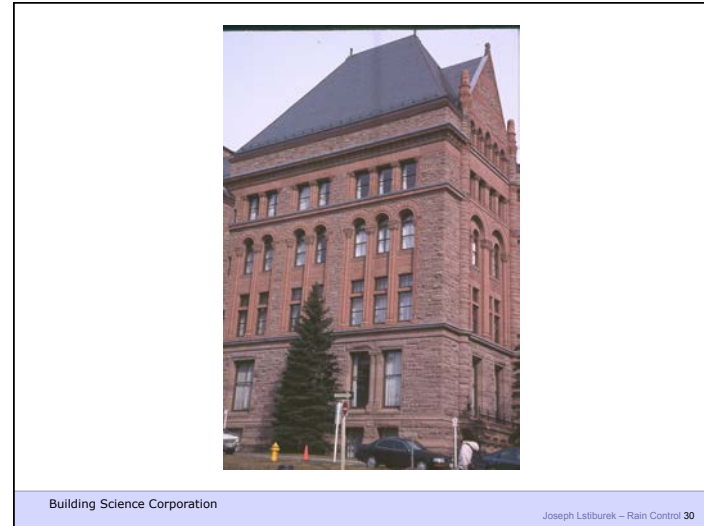

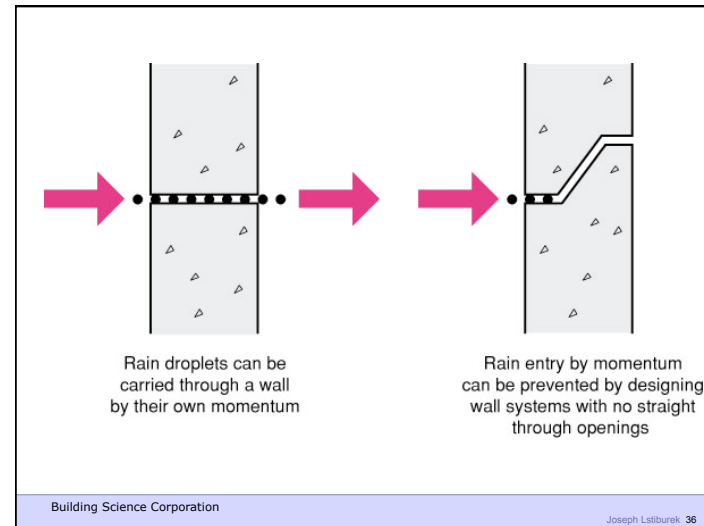
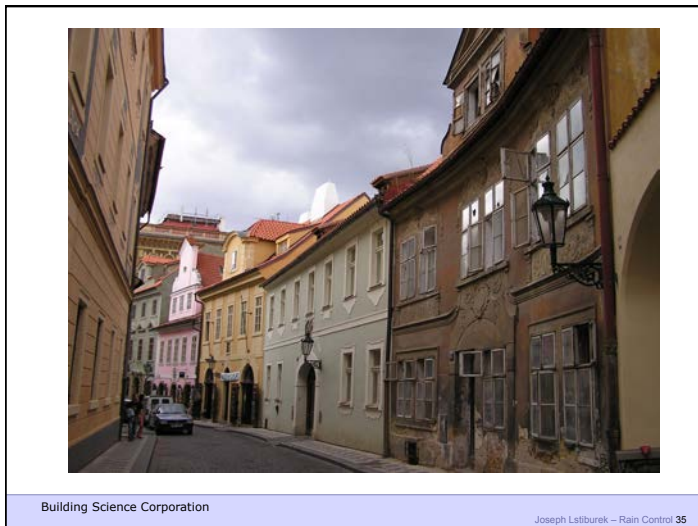
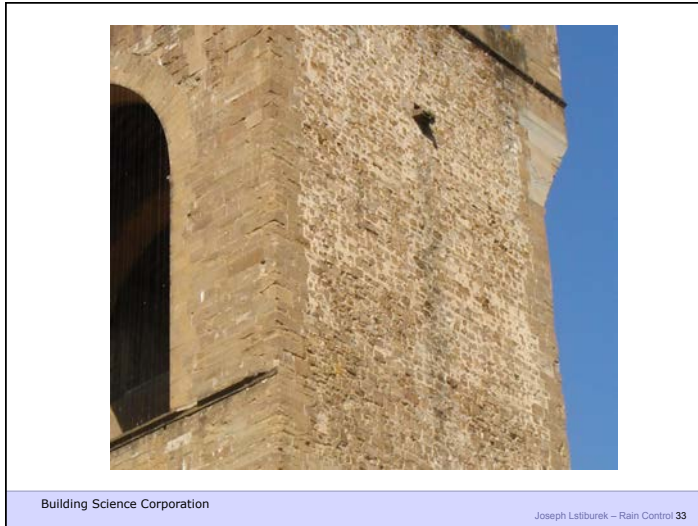

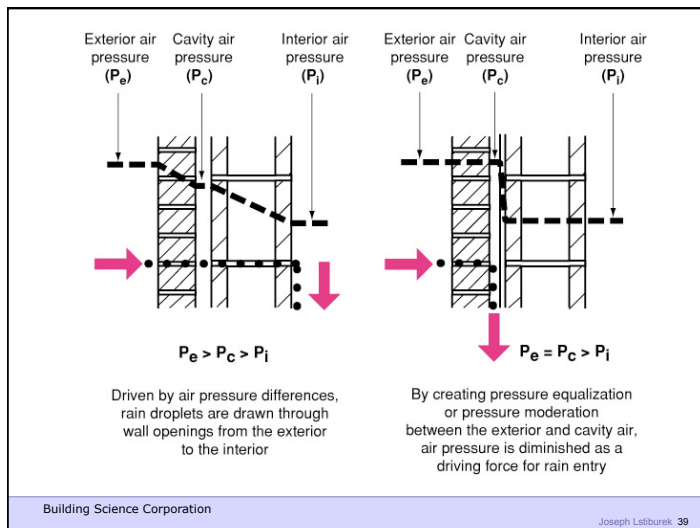
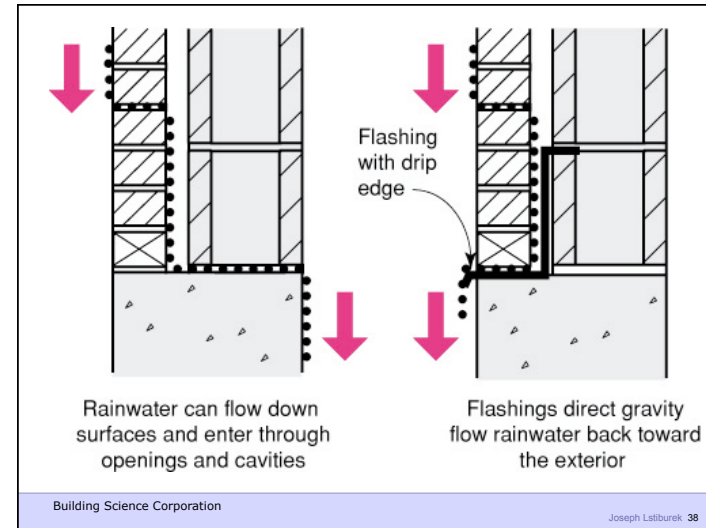
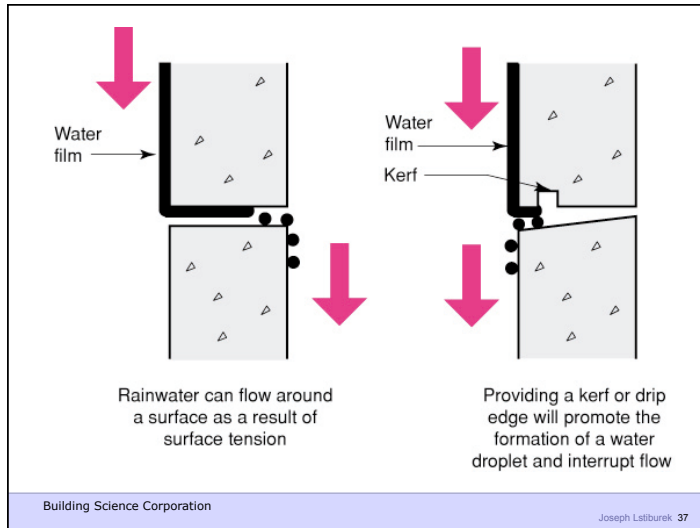

When We Talk About Rain We Also Include Capillary Flow

Building Science Corporation
Joseph Lstiburek 40

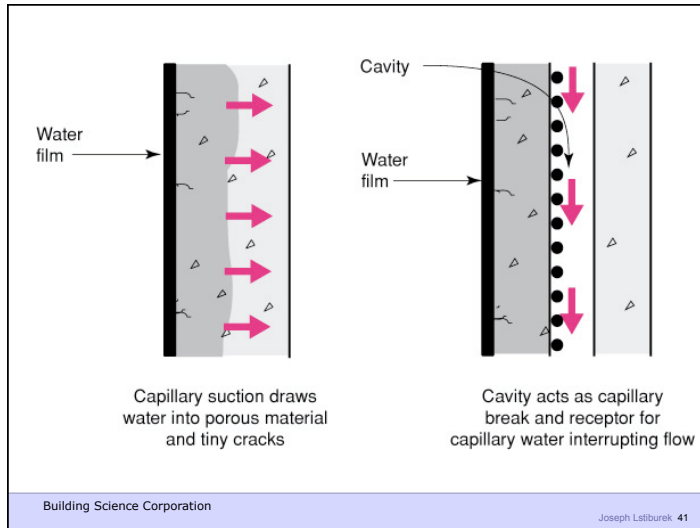

All We Have To Figure Out Is How Much Hits The Wall

Building Science Corporation

Joseph Lstiburek 42

All We Have To Figure Out Is How Much Hits The Wall

We Need Straube and Kuenzel

Building Science Corporation

Joseph Lstiburek 43

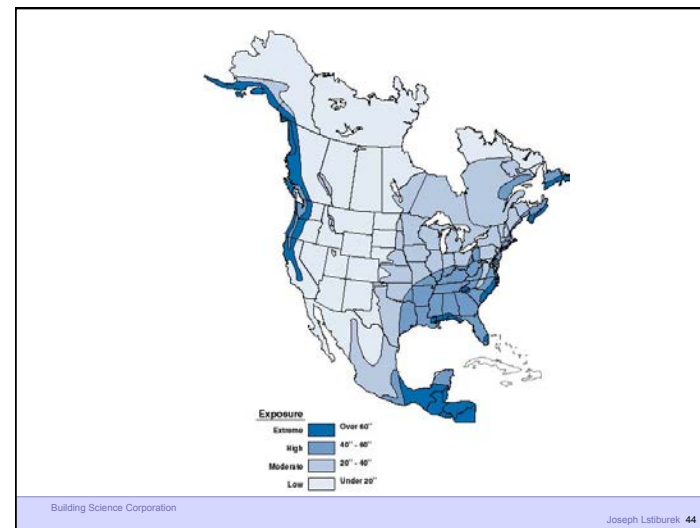

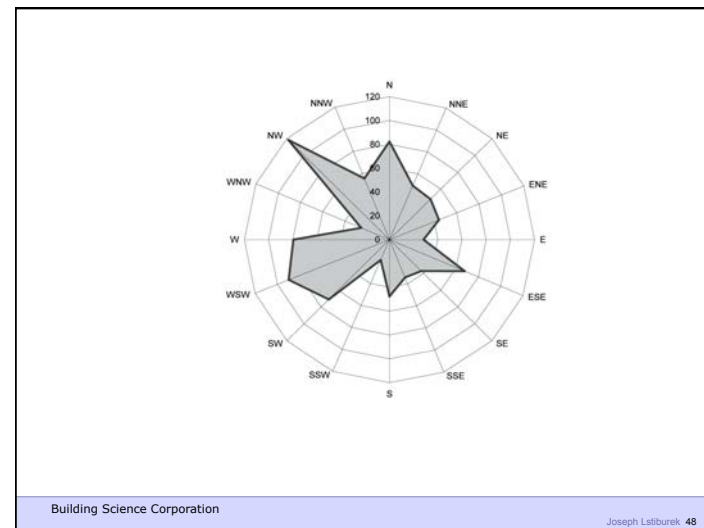
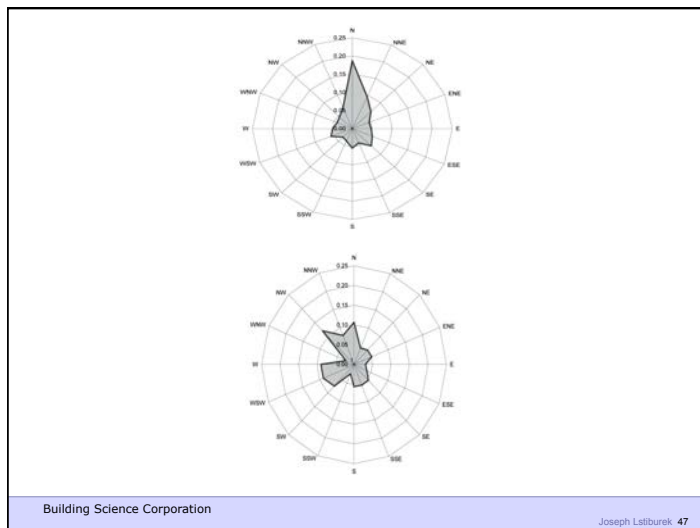
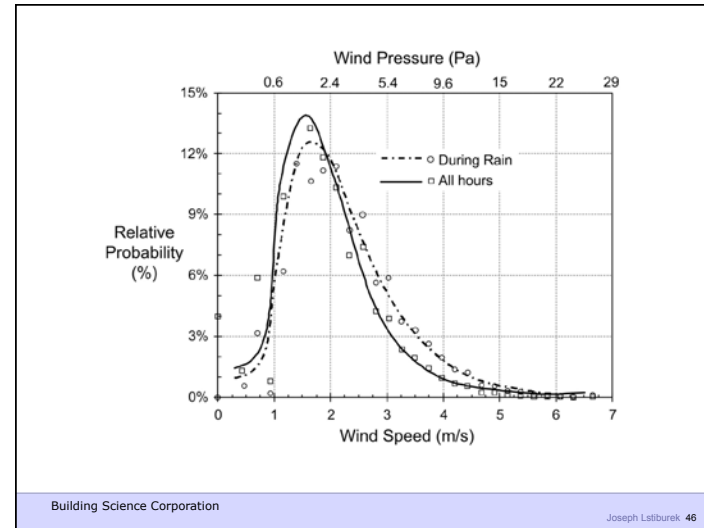
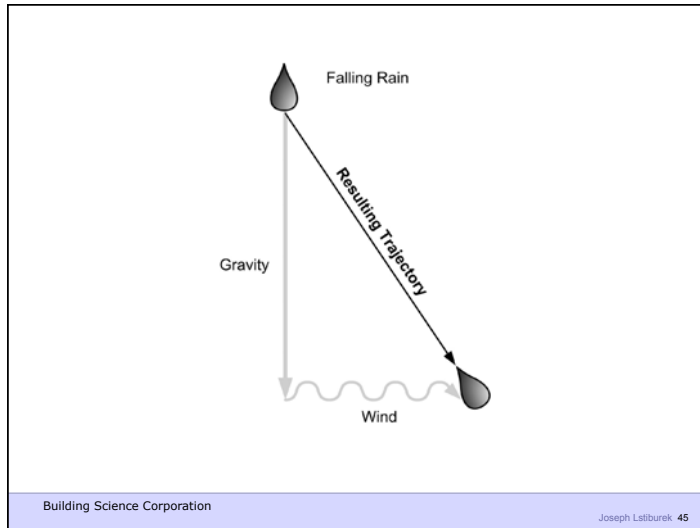

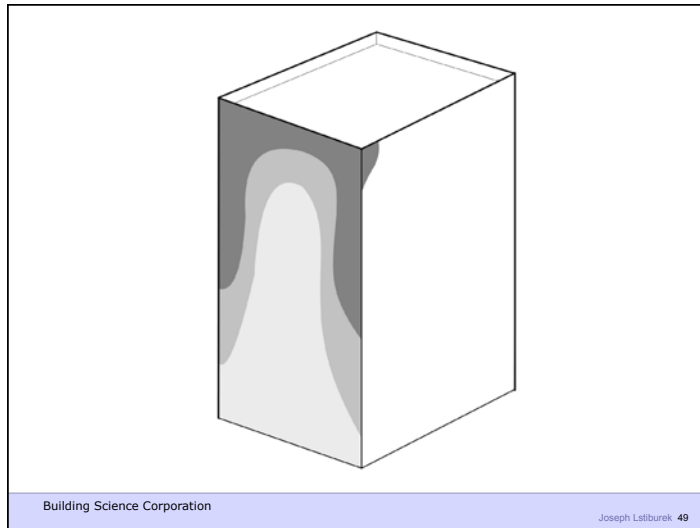

Building Science Corporation

Joseph Lstiburek 49

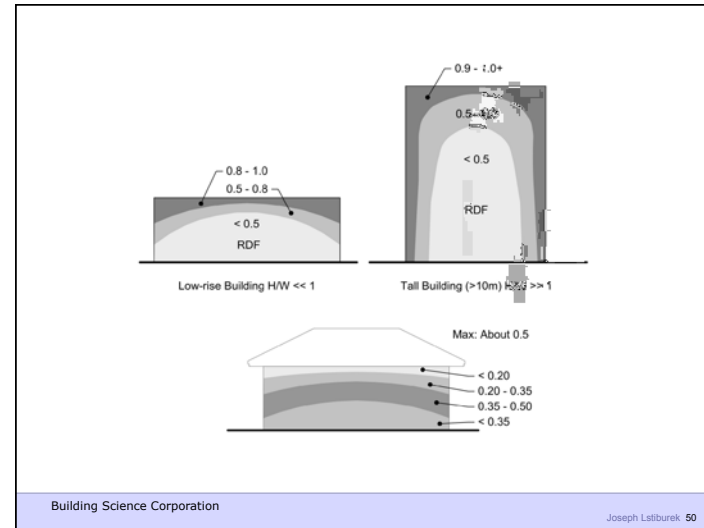

Building Science Corporation

Joseph Lstiburek 50

Bernoulli

$$P = \frac{1}{2} \rho V^2$$

P = stagnation pressure (Pa)
 ρ = air density (kg/m³)
 V = air velocity (m/s)

Code Design Pressure q

$$q = 0.647 \cdot V_{10}^2 \text{ (Pa)}$$

V₁₀ = design hourly mean wind speed 10 m above grade (m/s)

Building Science Corporation

Joseph Lstiburek 51

$$\Delta P = P_e - P_i$$

$$P_e = q \cdot C_e \cdot C_g \cdot C_{pe}$$

C_e = exposure factor
 C_g = gust factor
 C_{pe} = building specific pressure coefficient
 P_e is evaluated mid height.

$$P_i = q \cdot C_e \cdot C_{pi}$$

Note that C_{pi} is "negative"
 -0.3 for tall buildings
 -0.2 for low rise buildings

Building Science Corporation

Joseph Lstiburek 52

For a laboratory test, we take 20% of P_e .
For a field test, we take 2/3 of 20% of P_e which is equal to 13% of P_e .

ΔP is a very big number.
1 in 10 year pressure is the hourly average pressure likely to occur for one hour in 10 years.
Applying a gust factor of 2.5, the resultant pressure is likely to occur for one second every 10 years.

Rainfall intensity is less than 5 mm/hour (0.2 inches/hour) for more than 90% of the rain events (Kuenzel, 1994).

ASTM E1105 calls for 200 m/hour (8.0 inches/hour).
"Greatest recorded rainfall for a 1-hour period recorded in the contiguous 48 United States is 125 mm/hour (5.0 inches/hour)."

Wind speeds at the top of a 10-storey building will be about twice that of a 2-storey house.

The key is not wind speed (air pressure) but rain deposition.

99% of all rain events are lower than 20 Pa (13mph).

Most of North America has an average wind speed of 3.0 to 4.0 m/s at 10m above grade (less than 10 mph @ 30 ft).

Straube and Burnett, 2005

Building Science Corporation Joseph Lstiburek 57

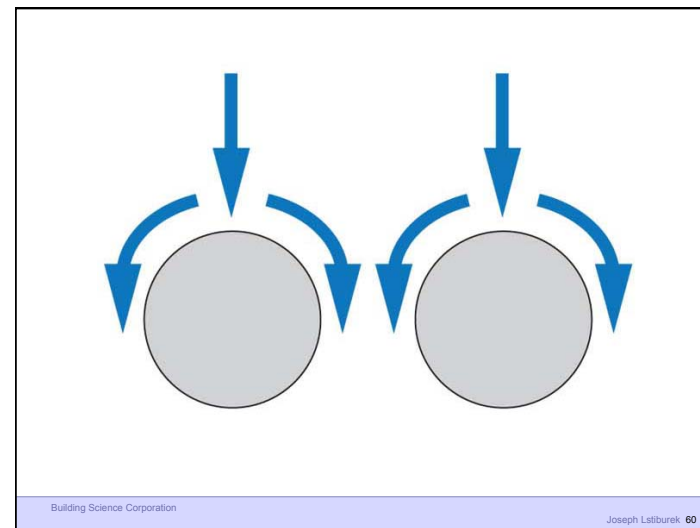
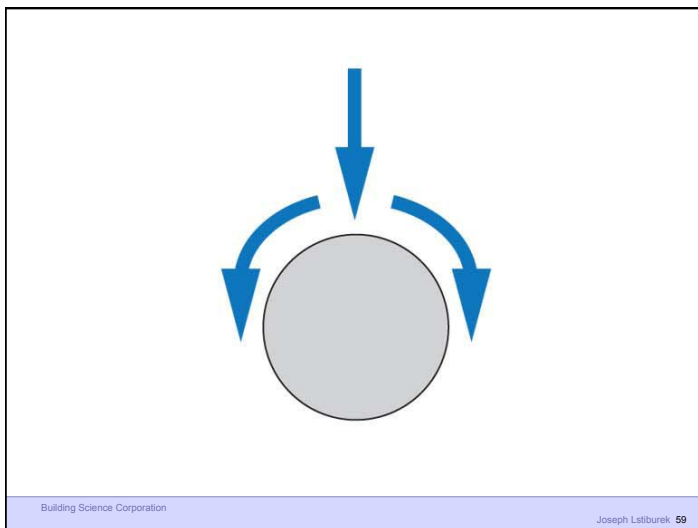
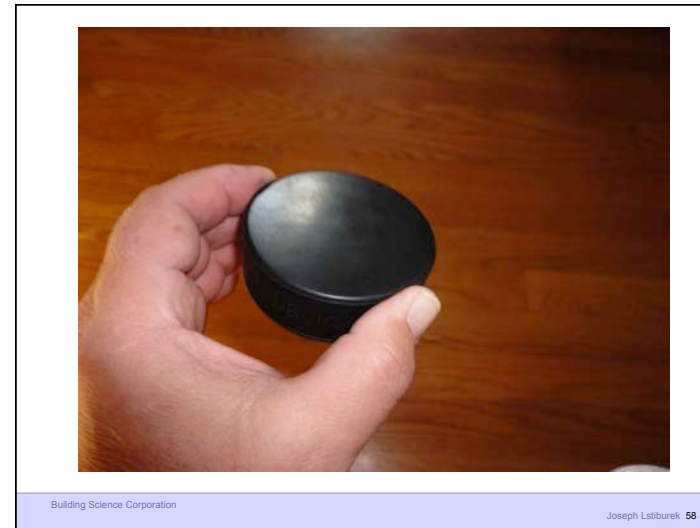

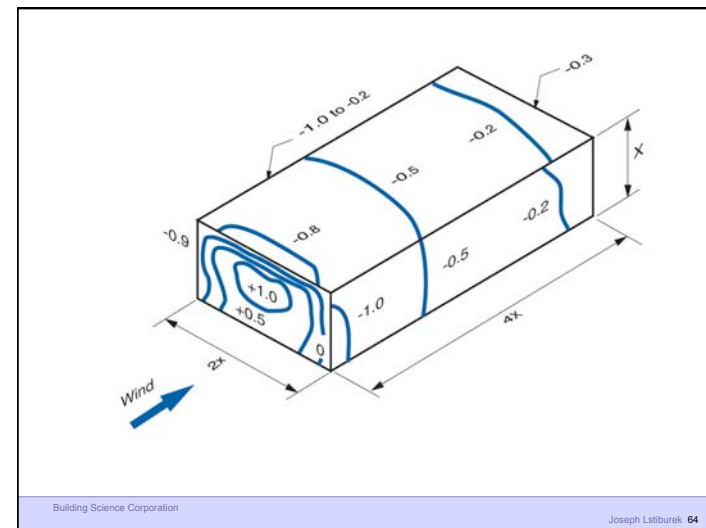
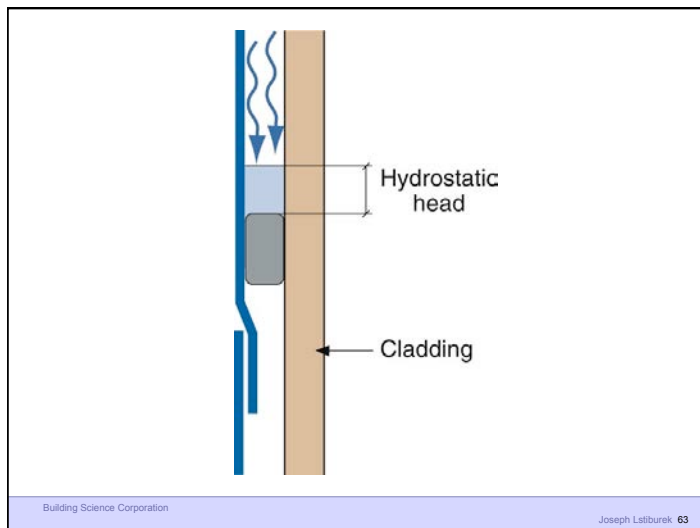
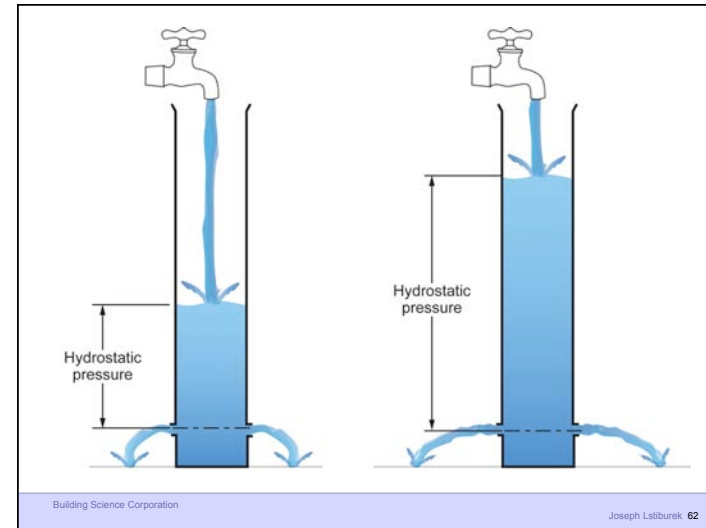
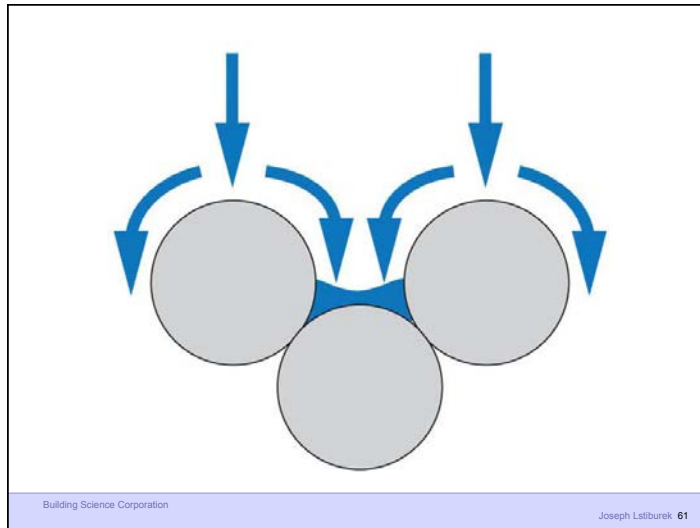

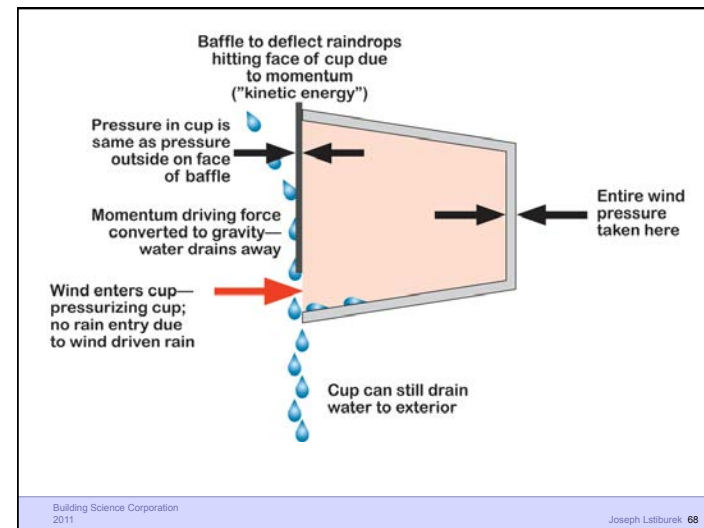
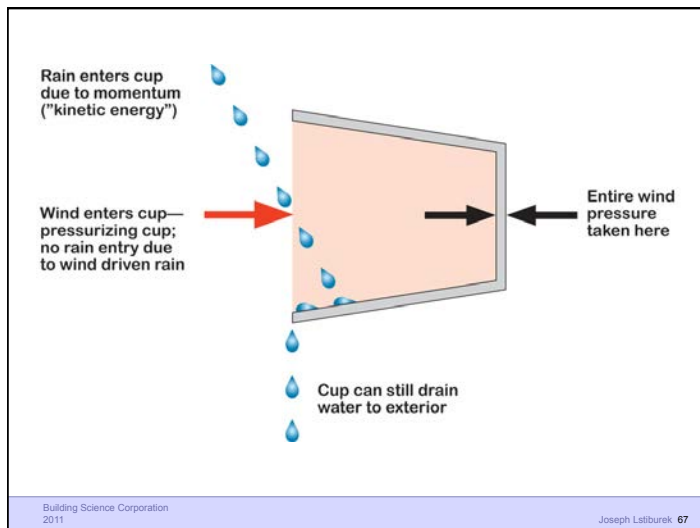
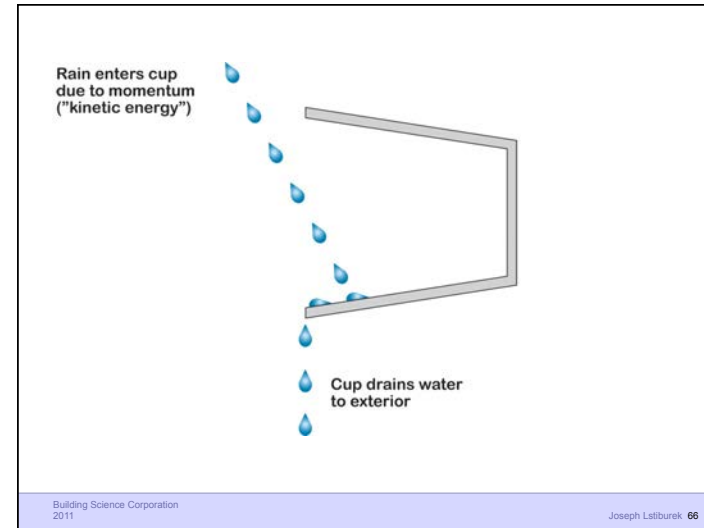
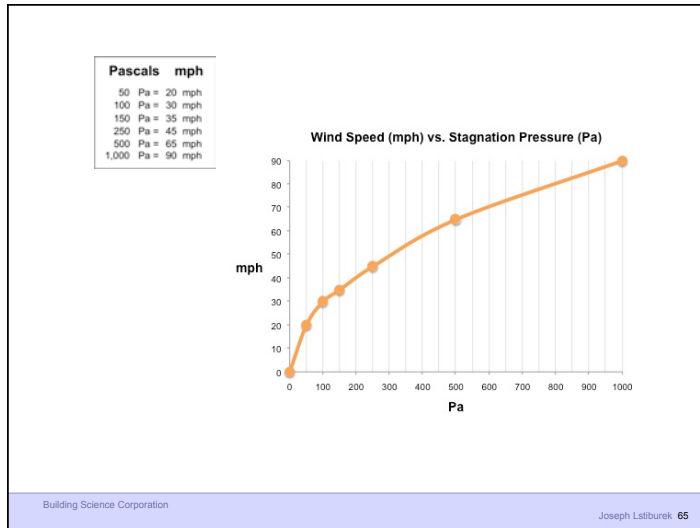

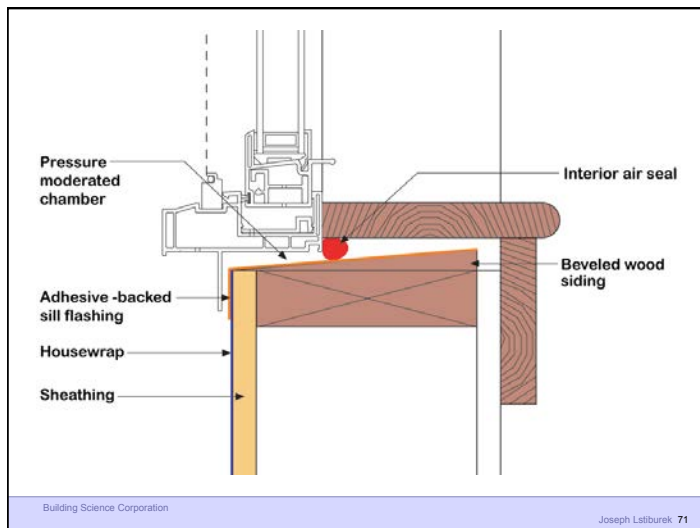
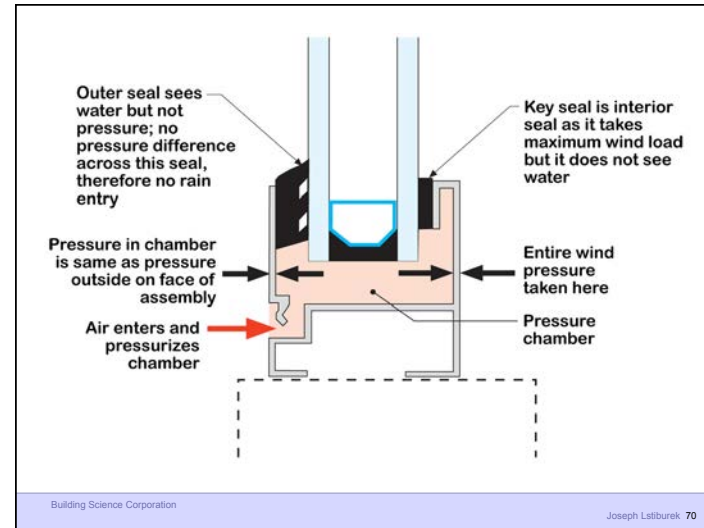
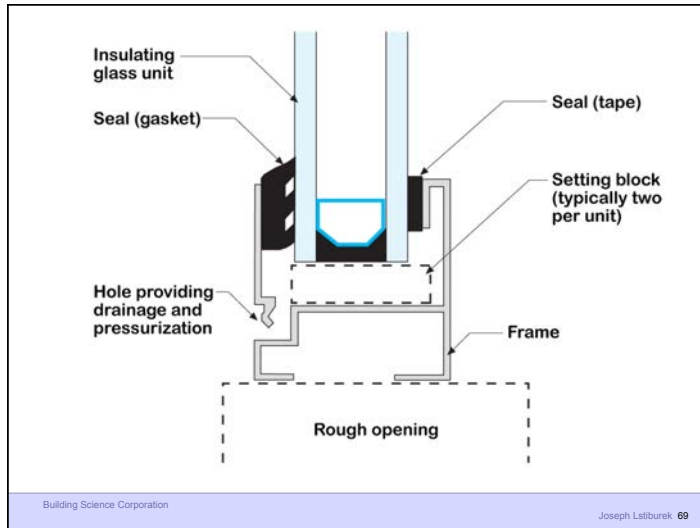

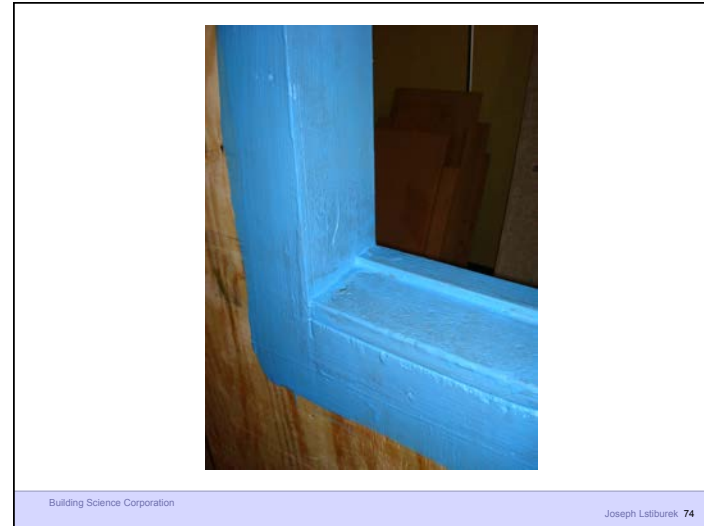

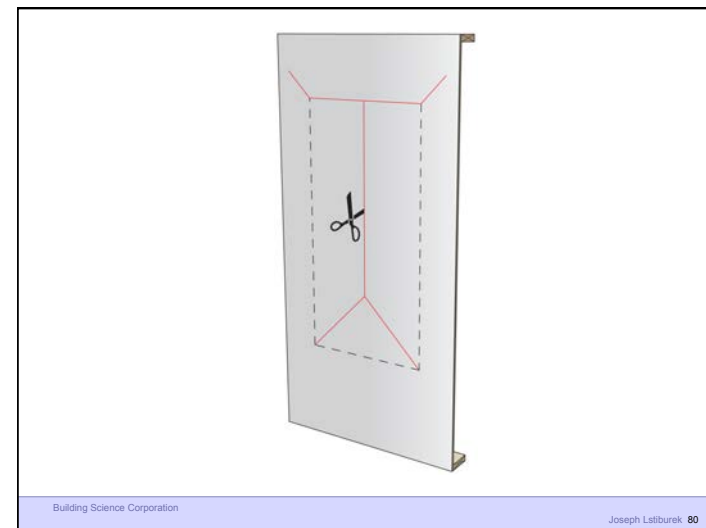
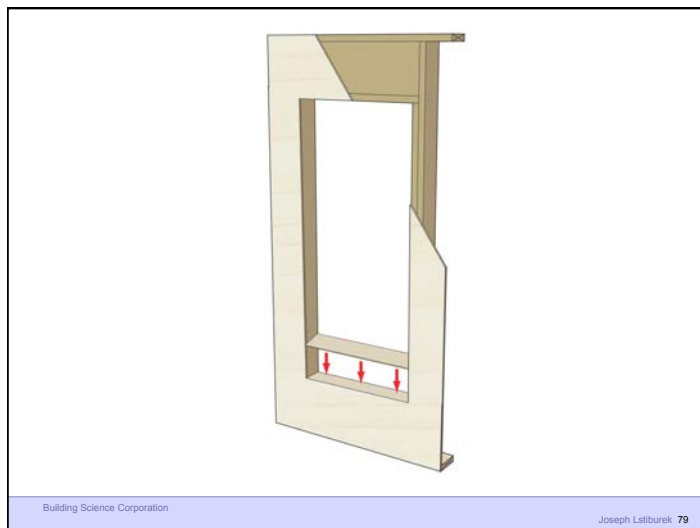
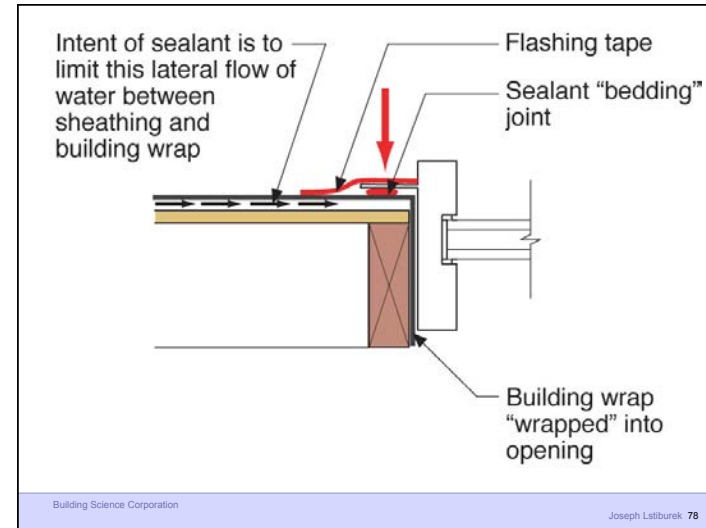

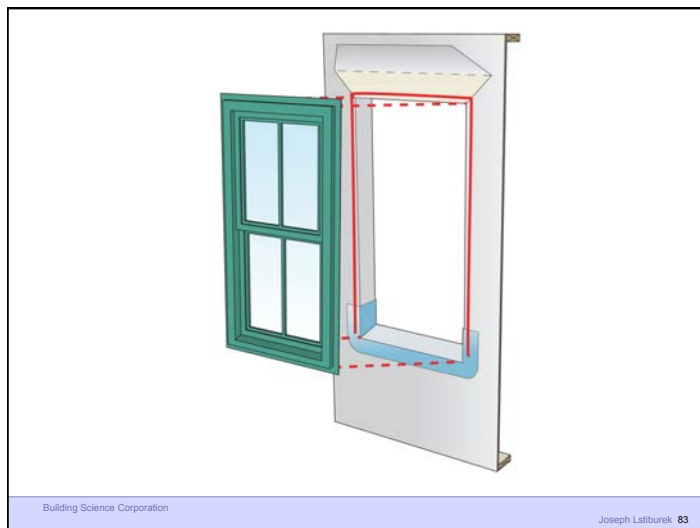
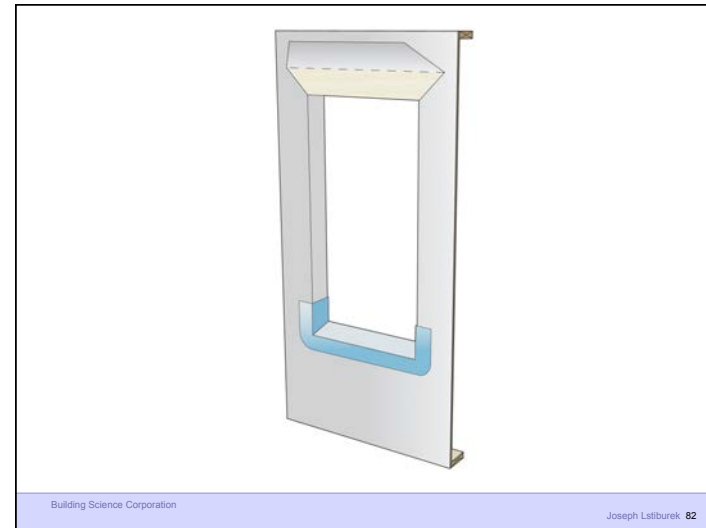
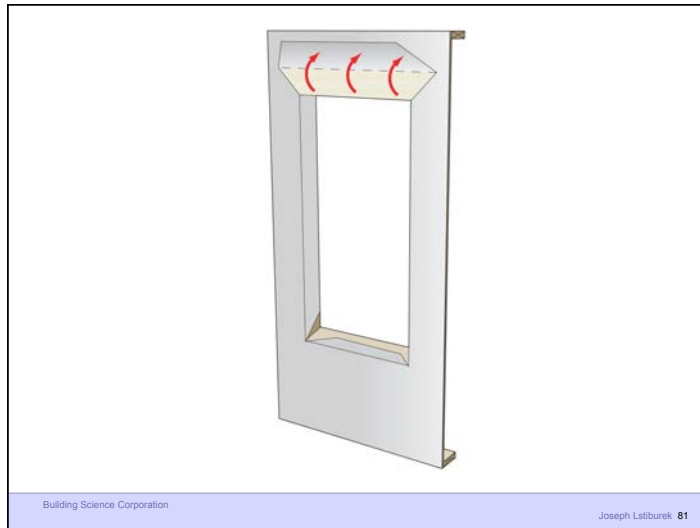



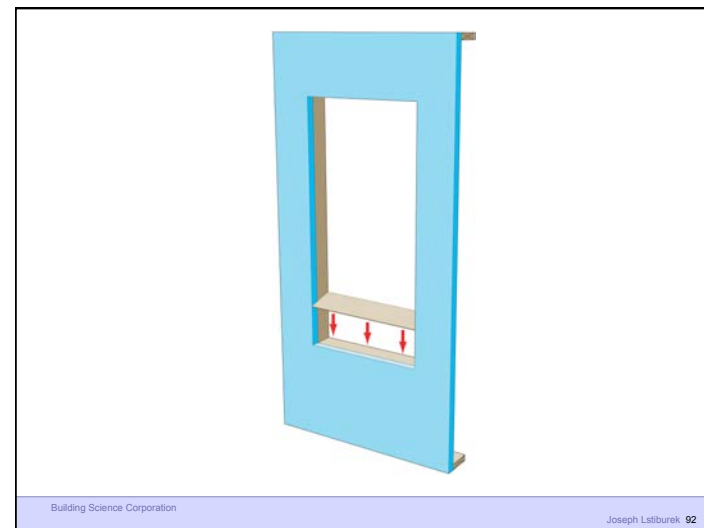
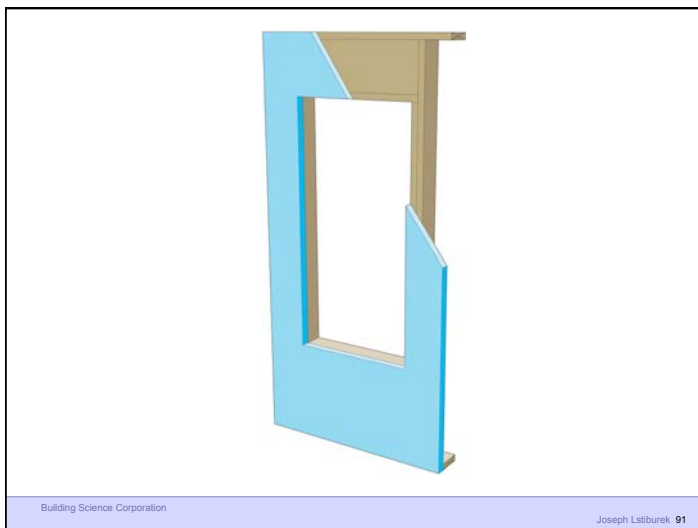

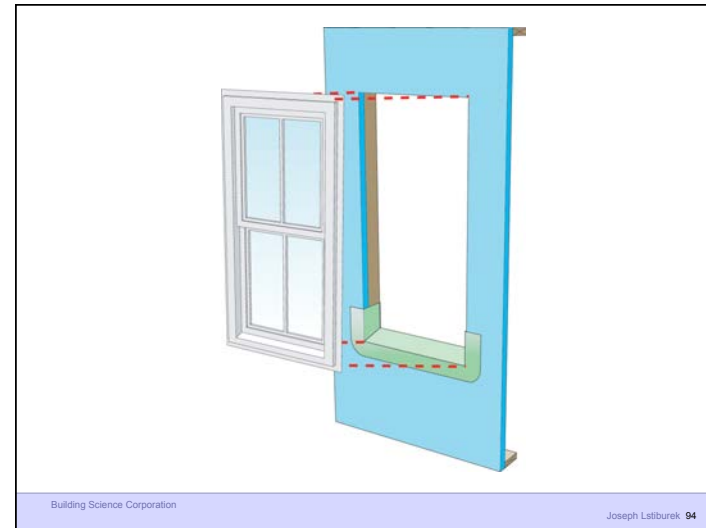
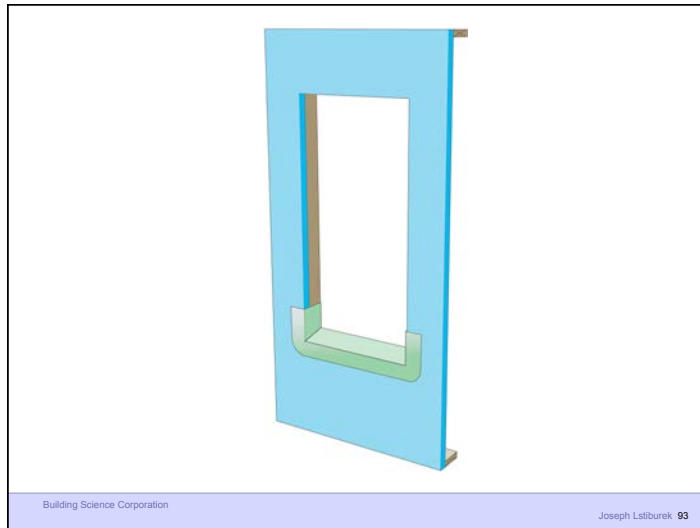

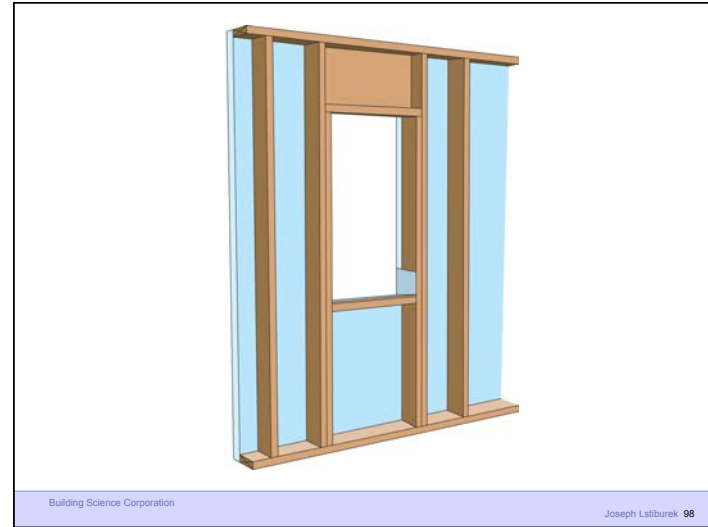
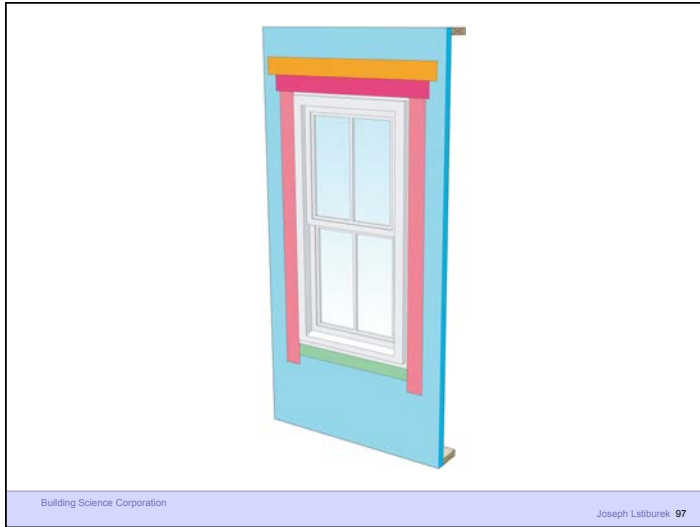

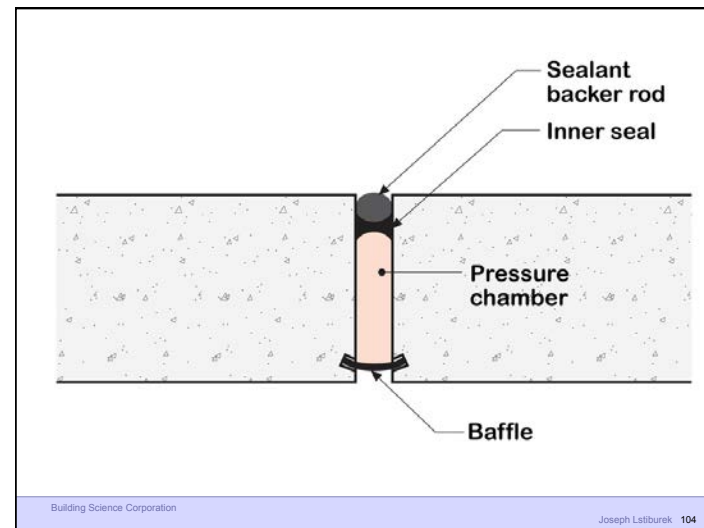
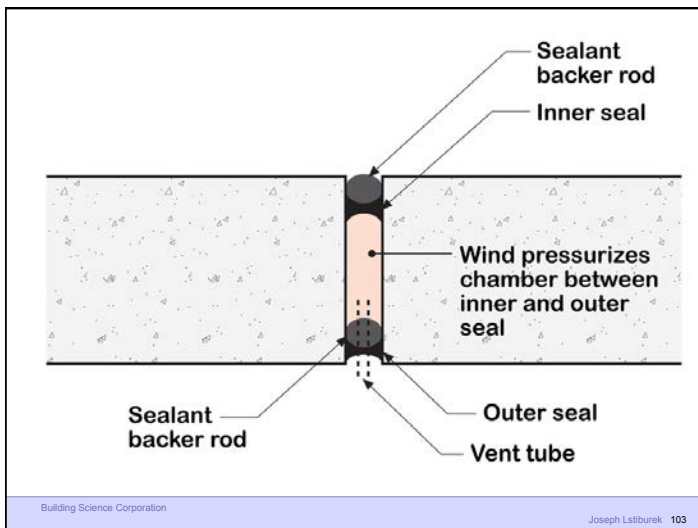
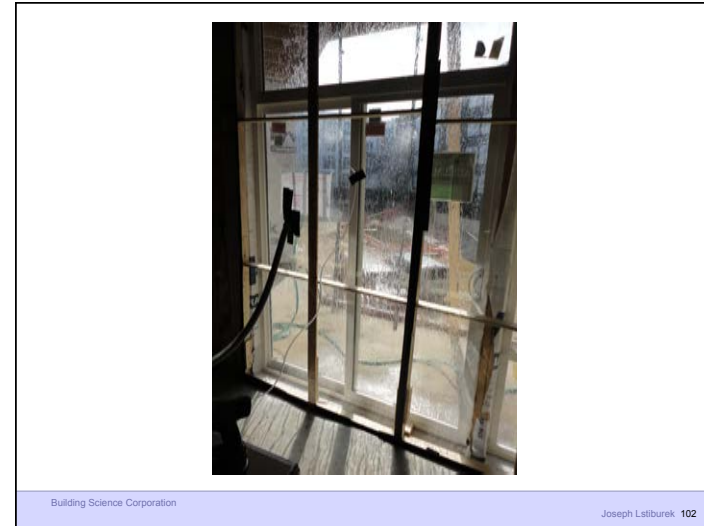

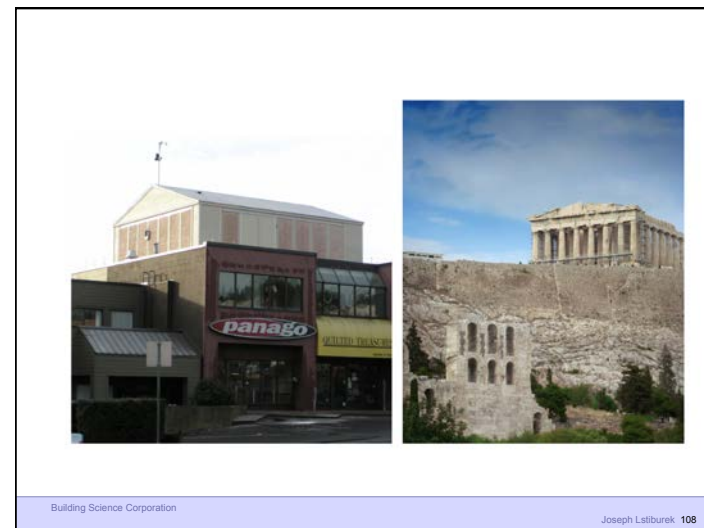
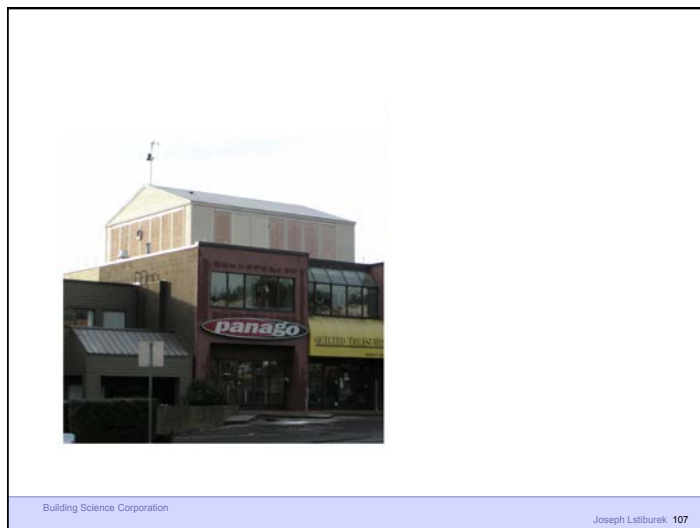
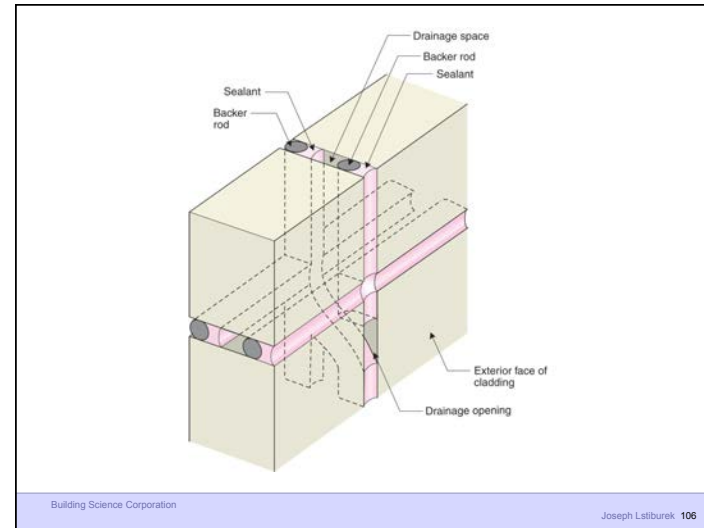
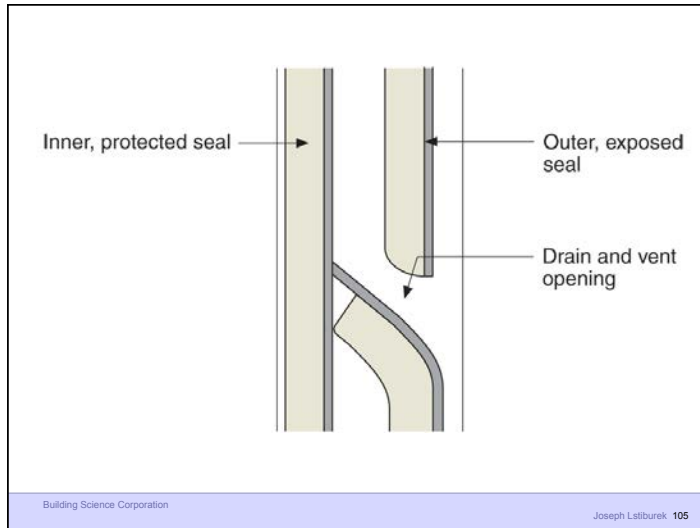

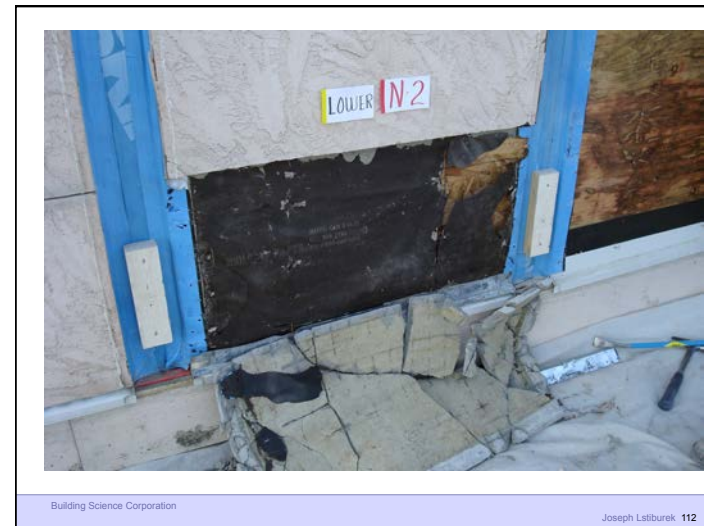
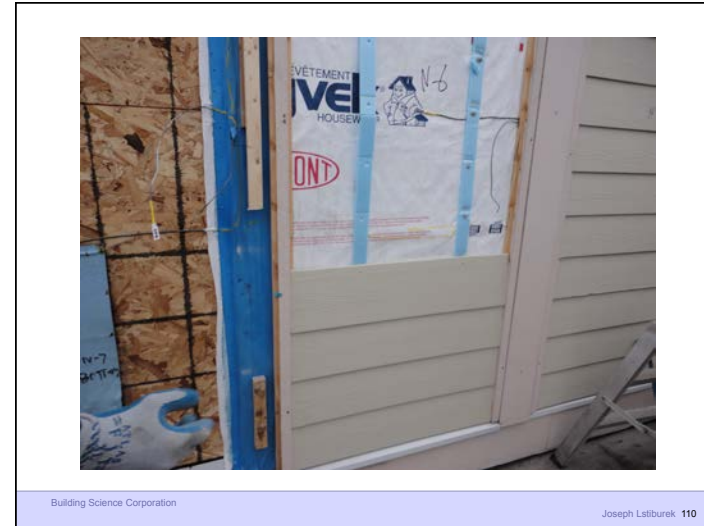



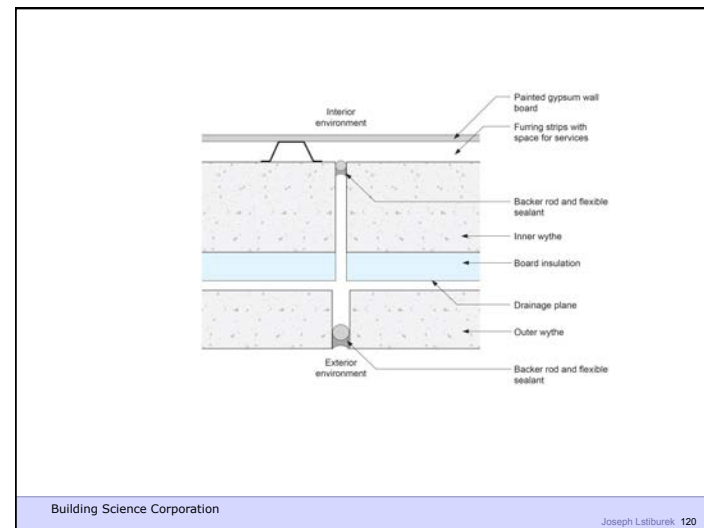

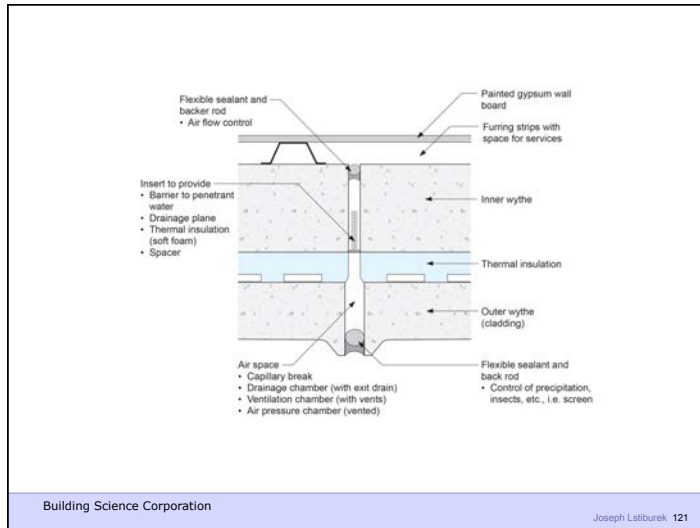

Building Science Corporation

Joseph Lstiburek 121

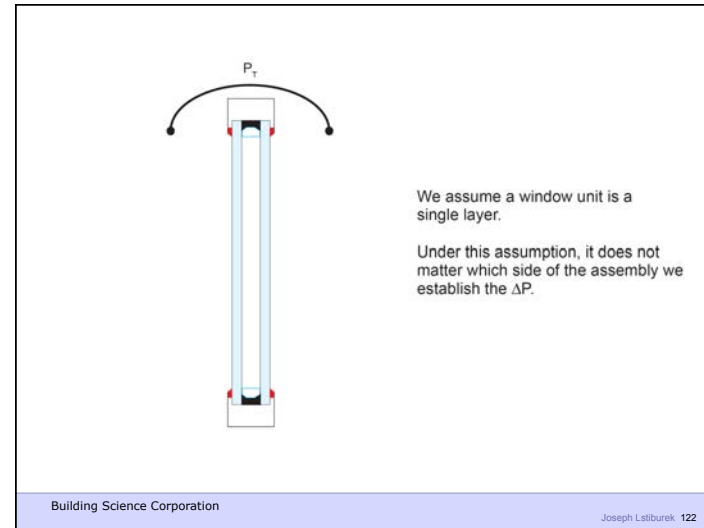

Building Science Corporation

Joseph Lstiburek 122

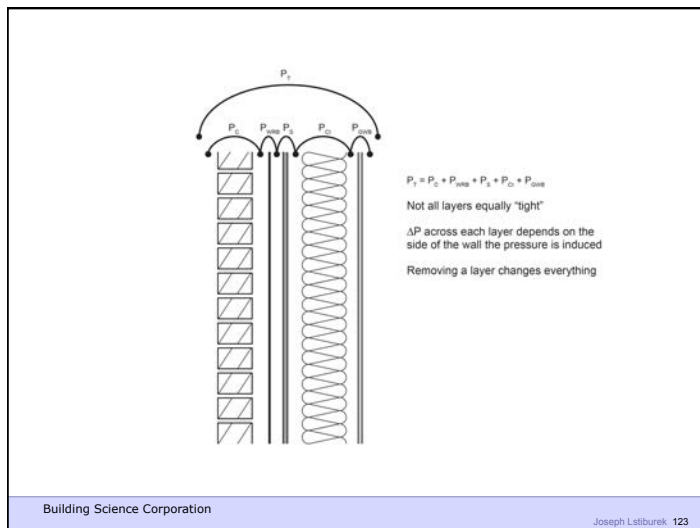

Building Science Corporation

Joseph Lstiburek 123

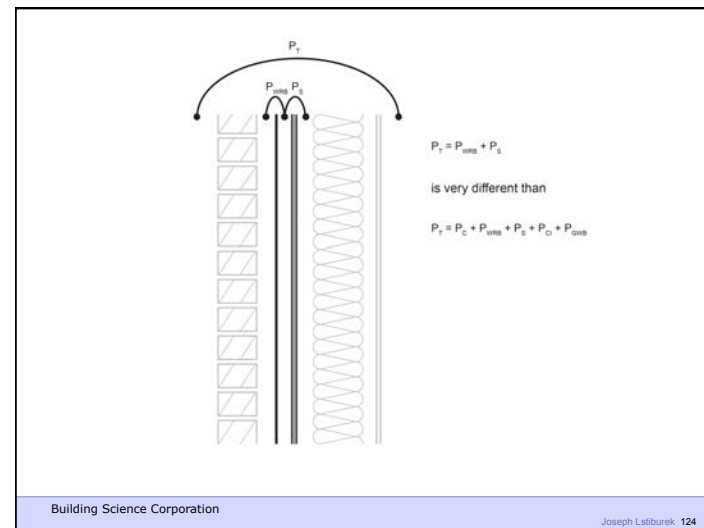

Building Science Corporation

Joseph Lstiburek 124

