

Joseph Lstiburek, Ph.D., P.Eng, ASHRAE Fellow

Building Science

Roofs

presented by www.buildingscience.com

Water Control Layer
Air Control Layer
Vapor Control Layer
Thermal Control Layer

Building Science Corporation

Joseph Lstiburek 2

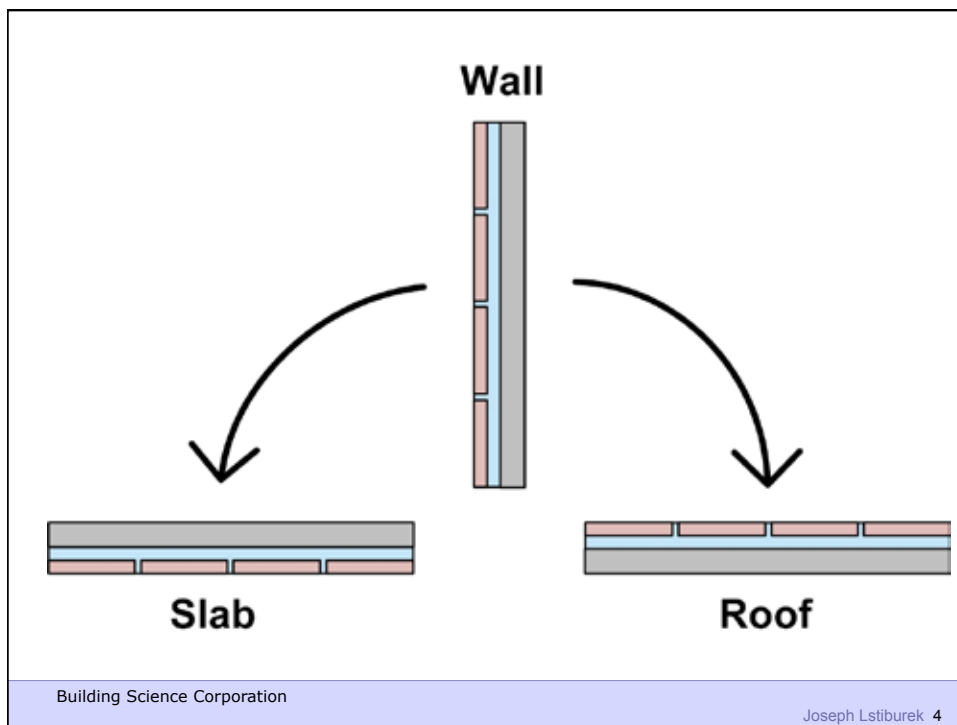
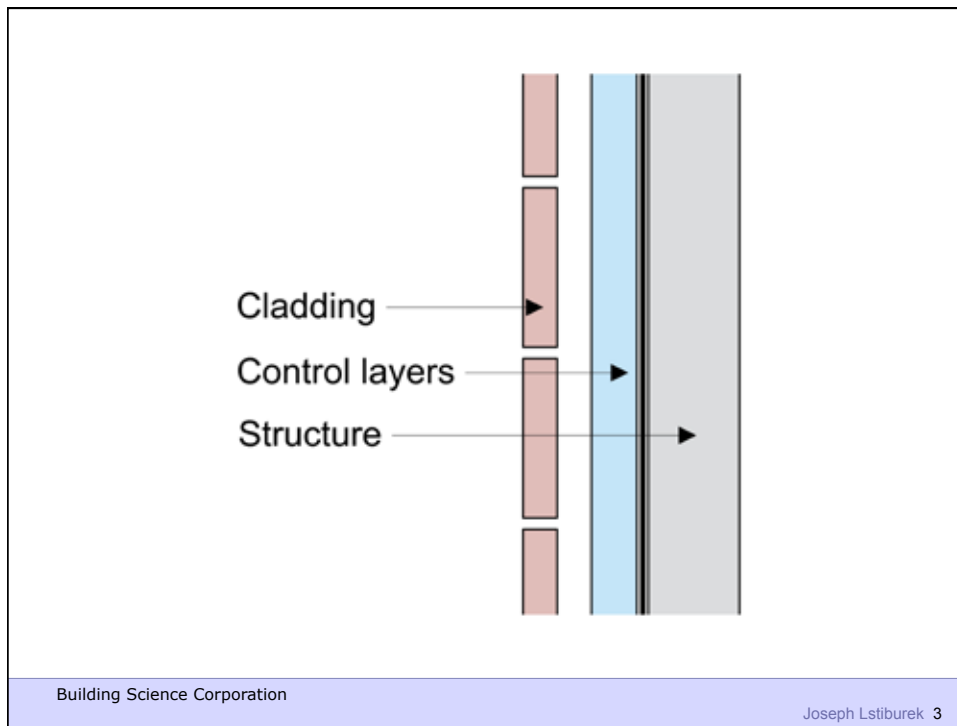

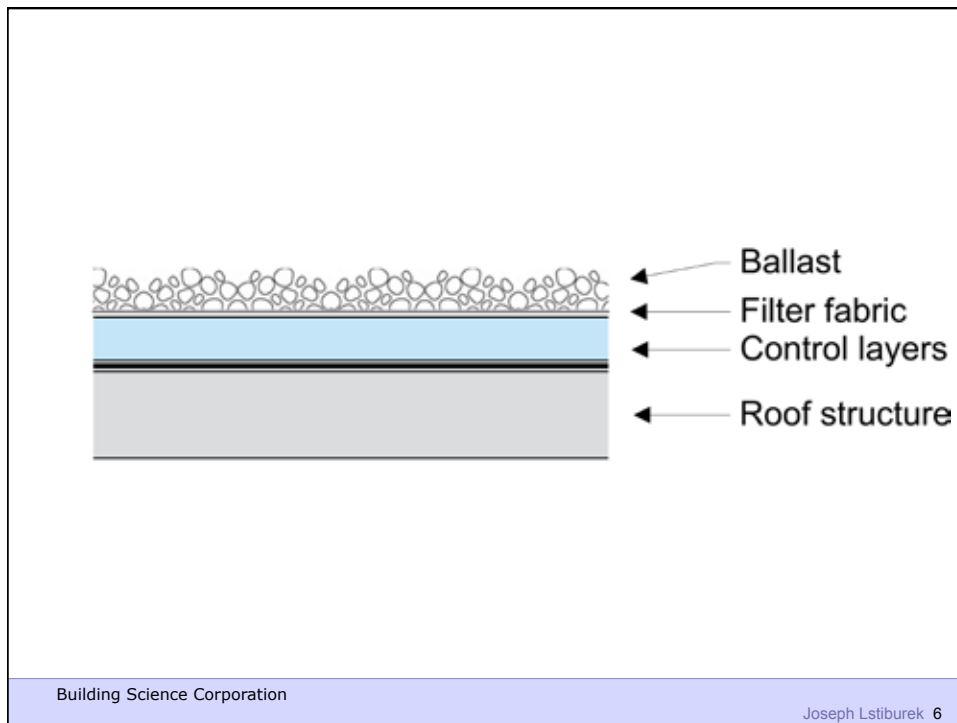
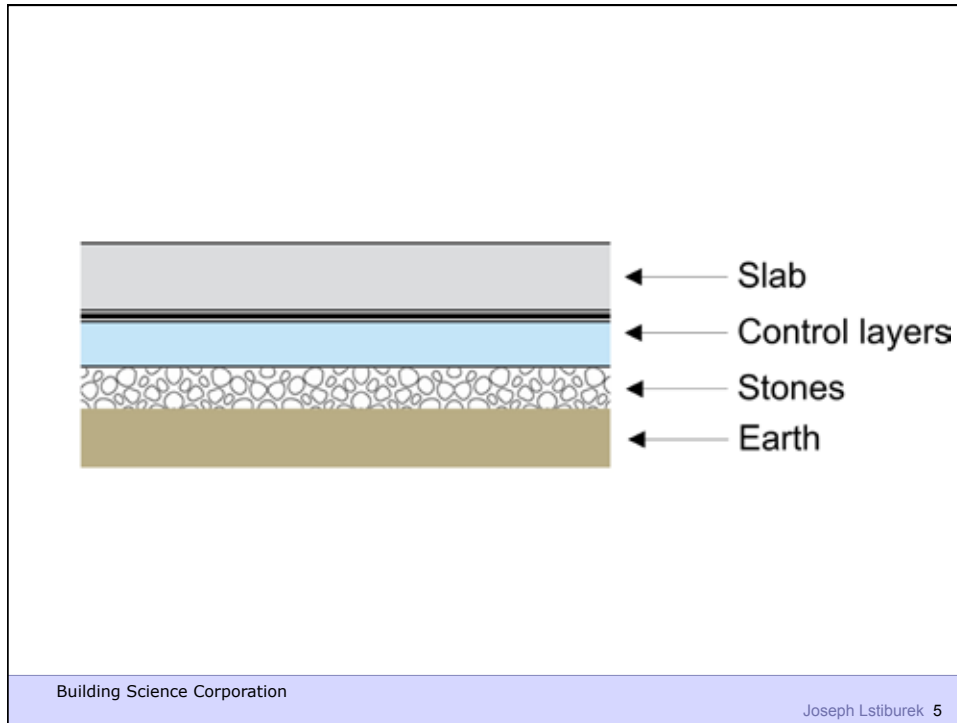

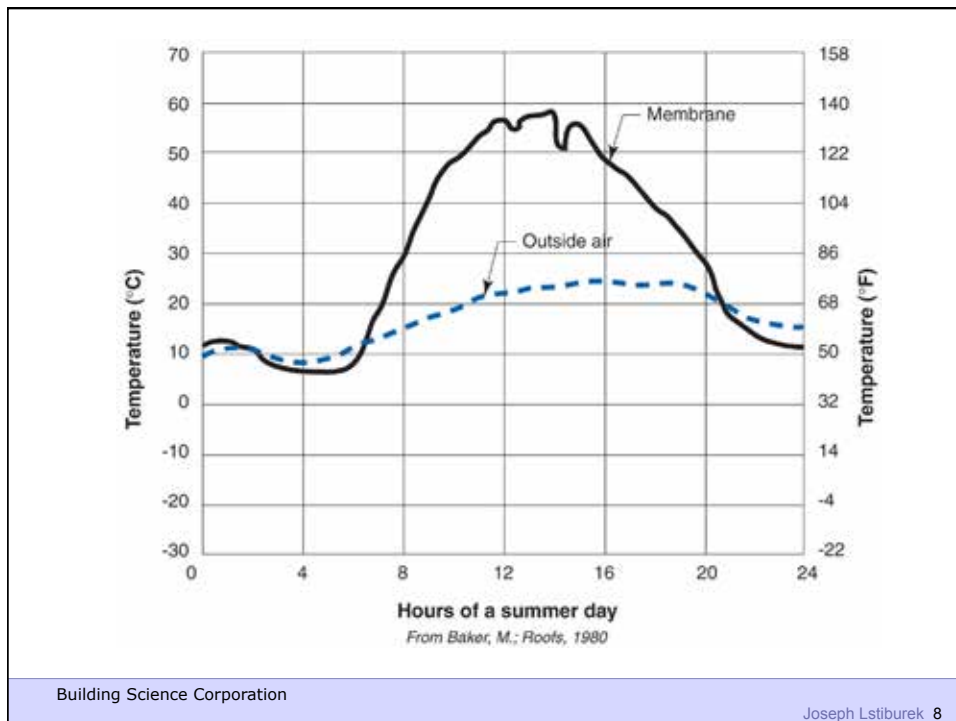
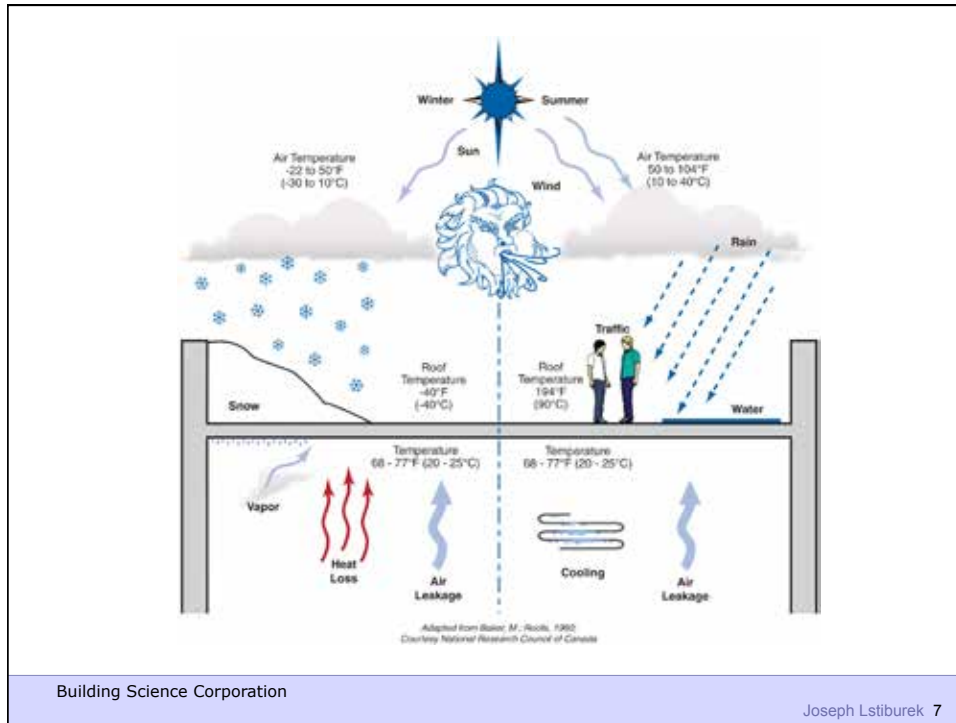

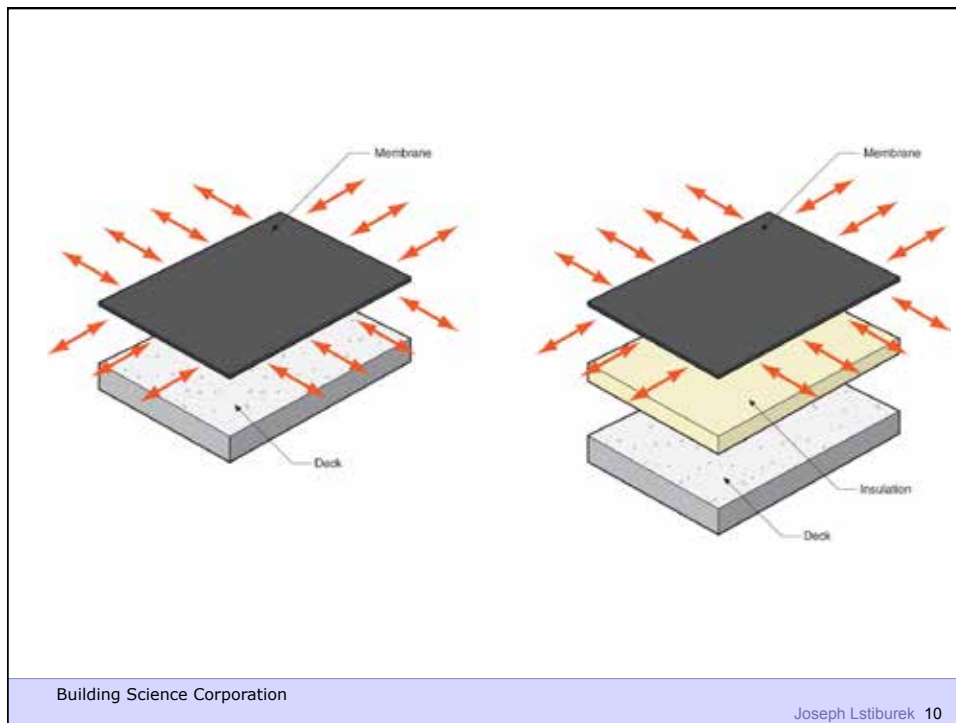
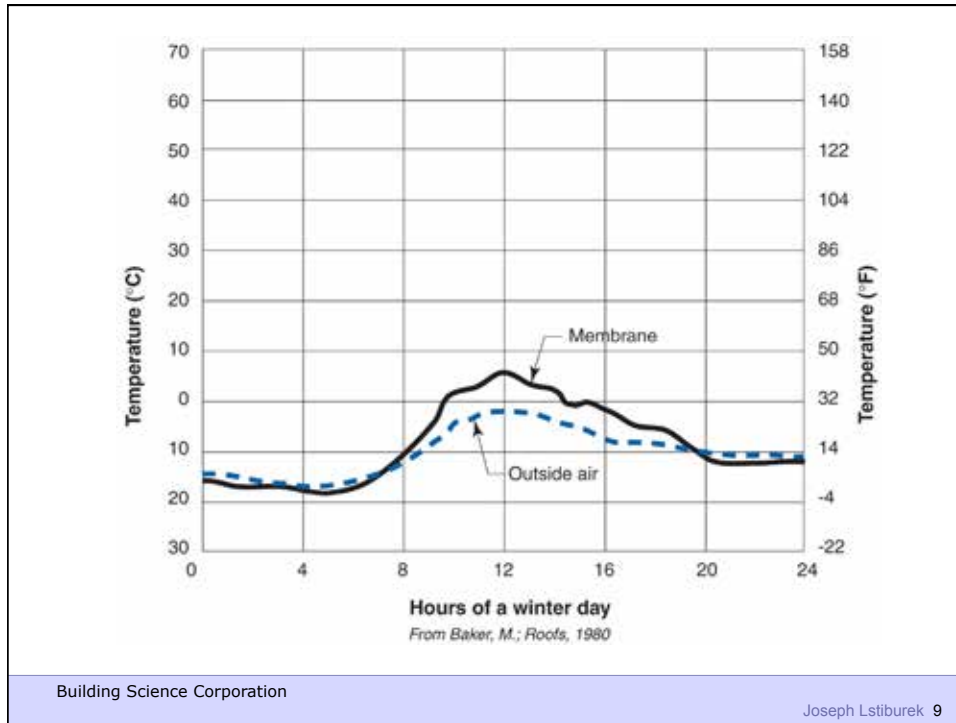

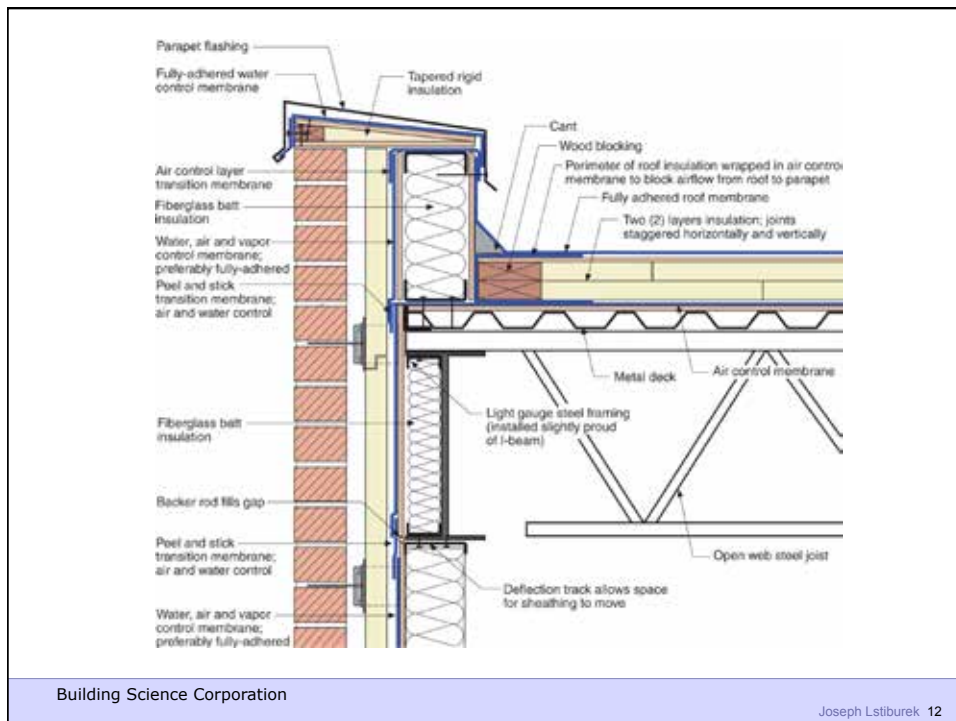
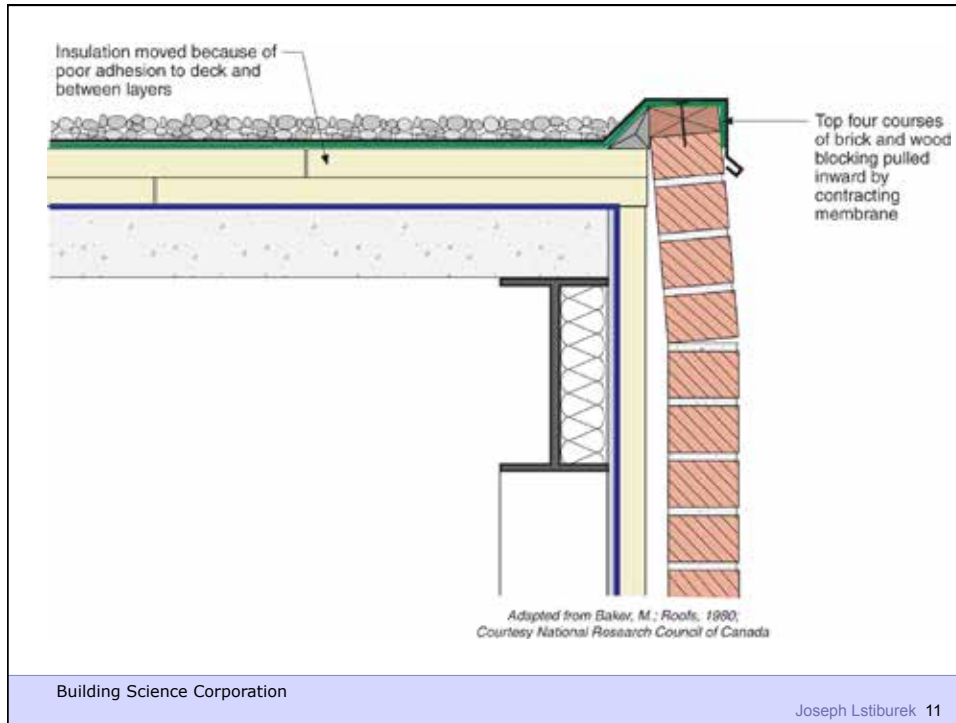

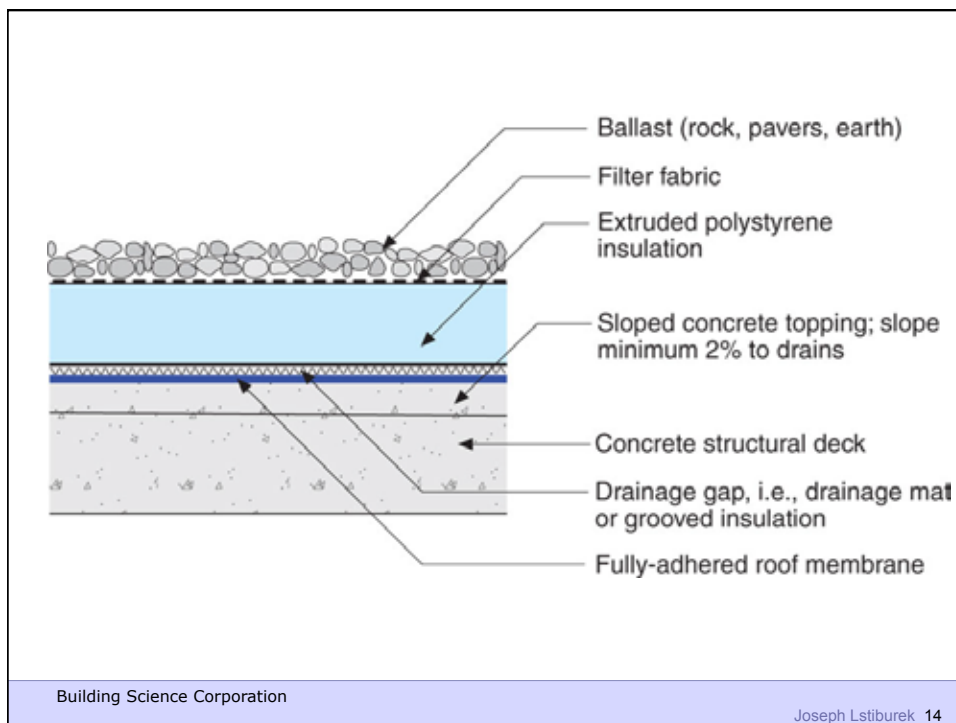
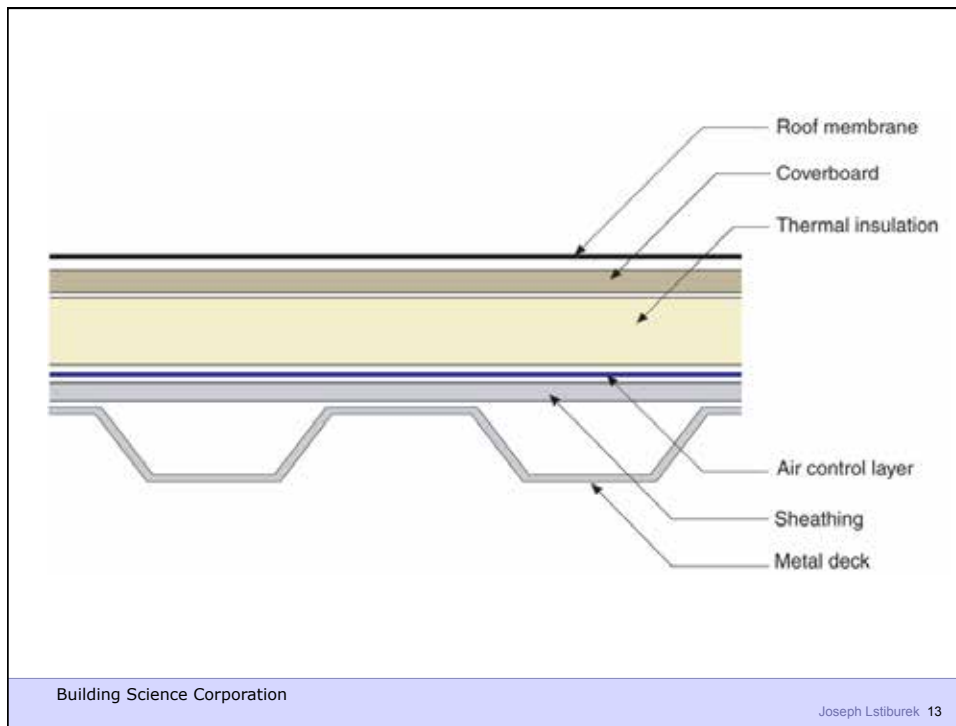

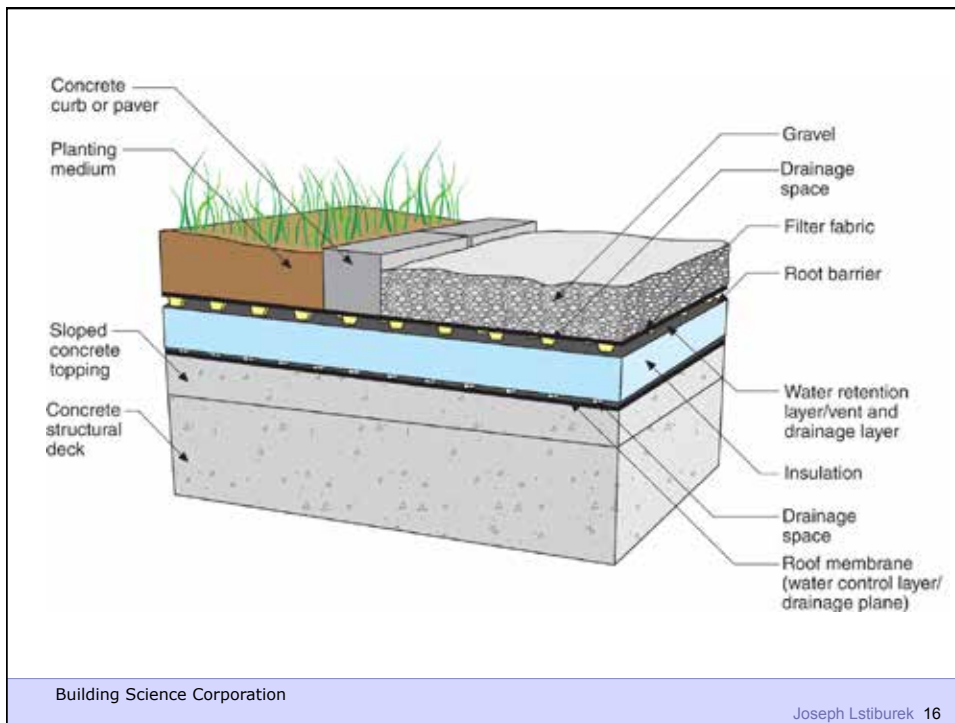



Building Science Corporation

Joseph Lstiburek 17



Building Science Corporation

Joseph Lstiburek 18



Building Science Corporation

Joseph Lstiburek 19



Building Science Corporation

Joseph Lstiburek 20

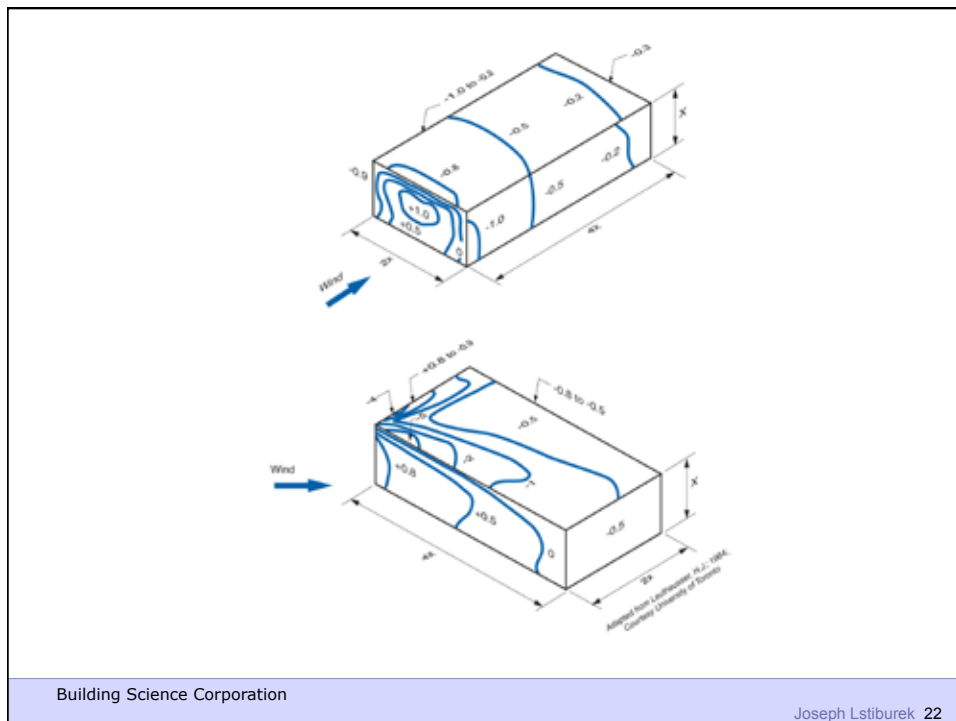
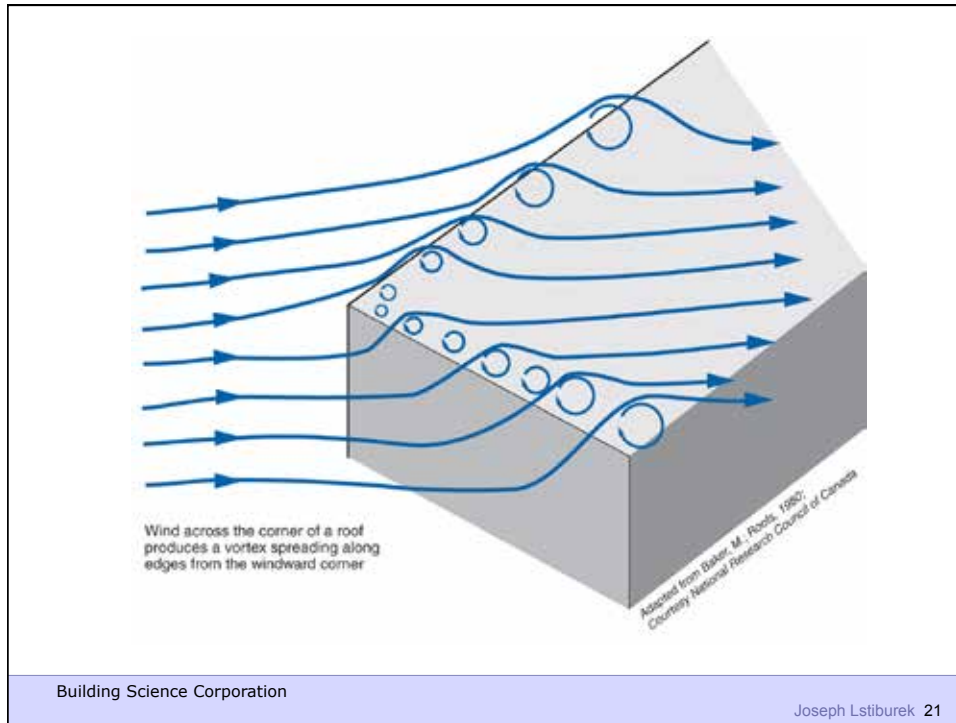

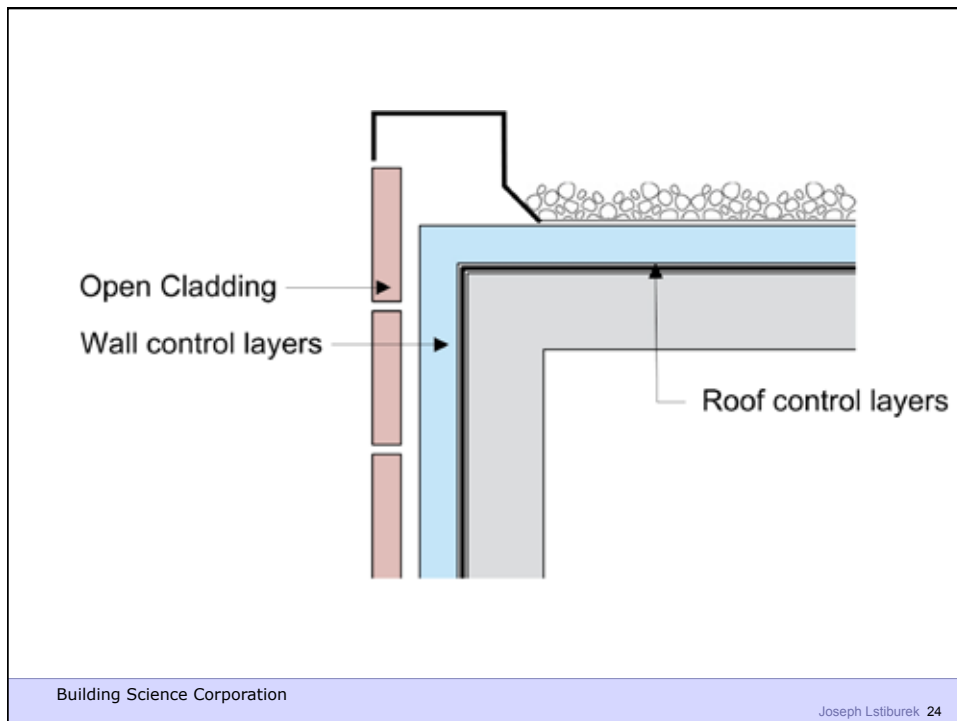
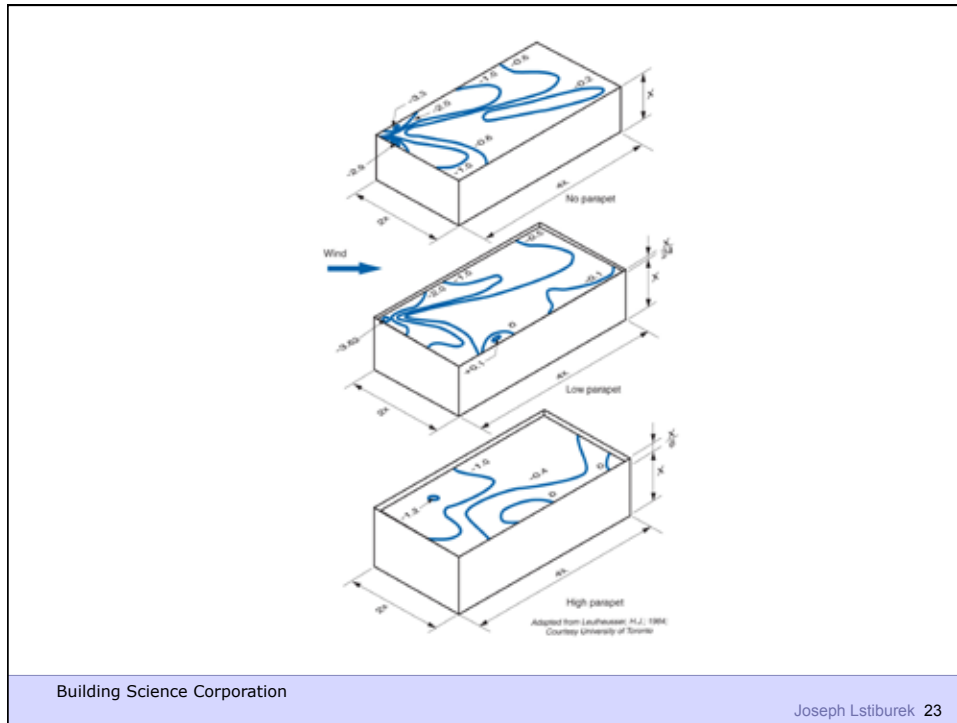

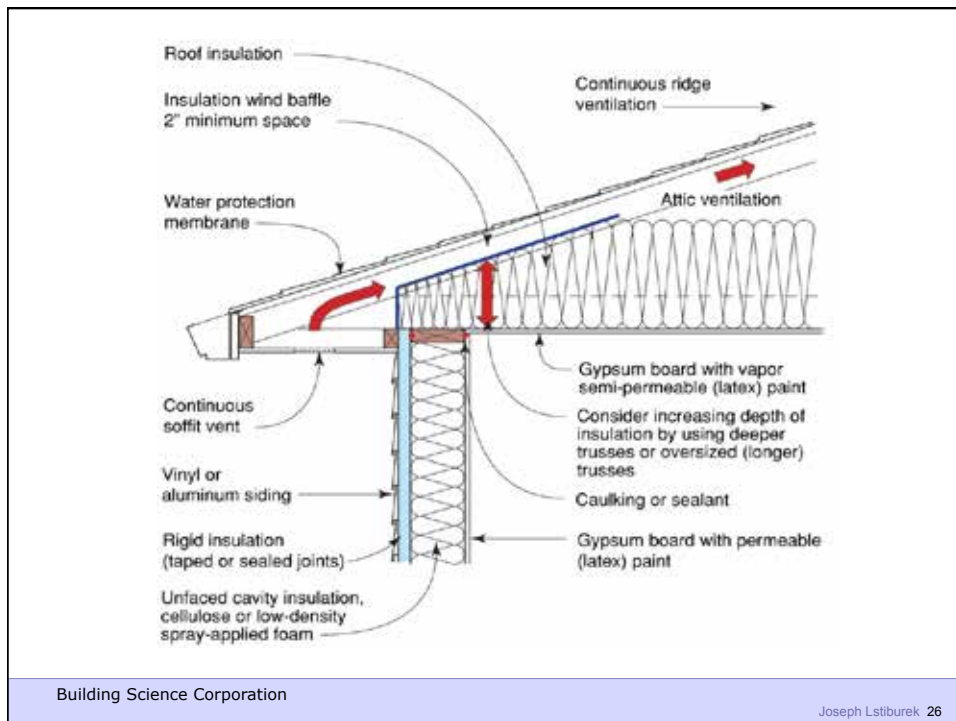
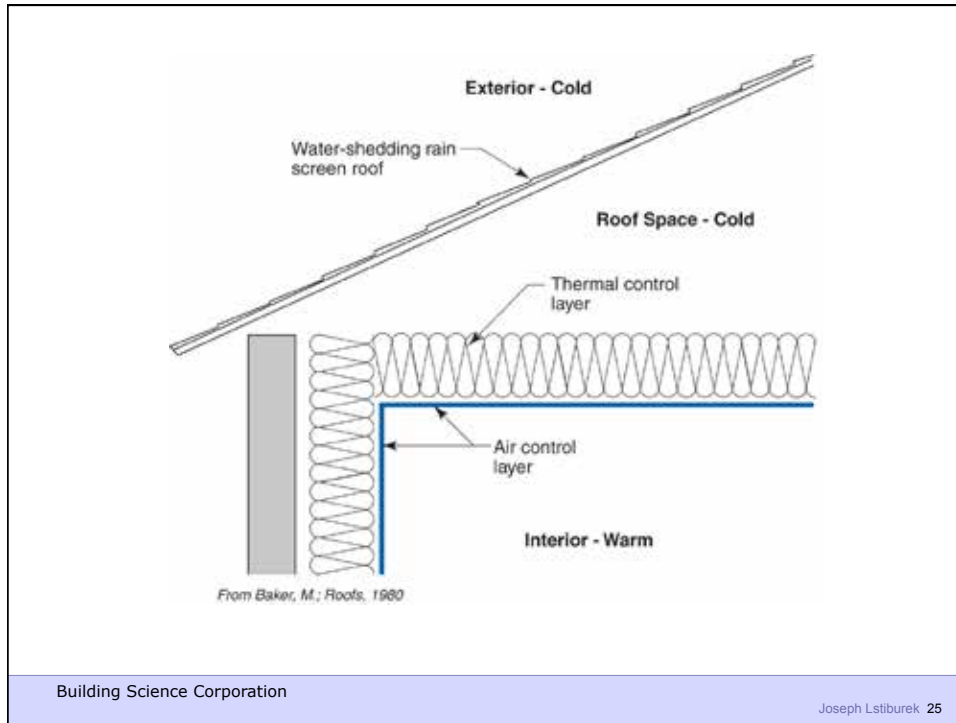



Building Science Corporation

Joseph Lstiburek 27

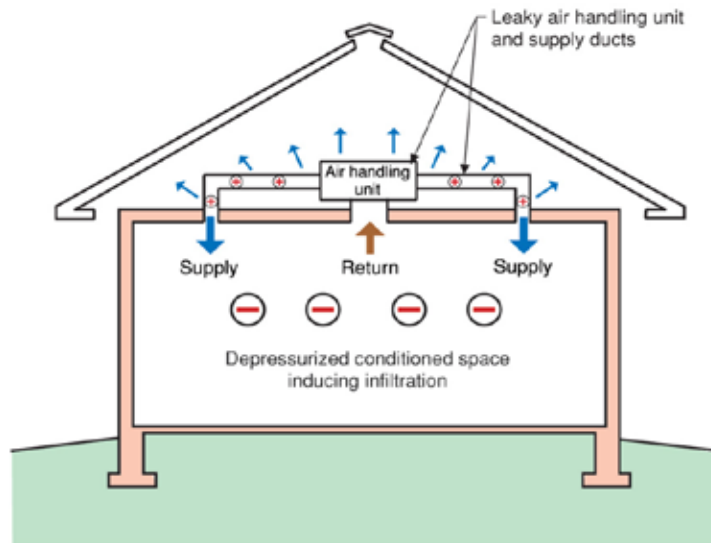

Note: Colored shading depicts the building's thermal barrier and pressure boundary. The thermal barrier and pressure boundary enclose the conditioned space.

Building Science Corporation

Joseph Lstiburek 28



Building Science Corporation

Joseph Lstiburek 29



Building Science Corporation

Joseph Lstiburek 30

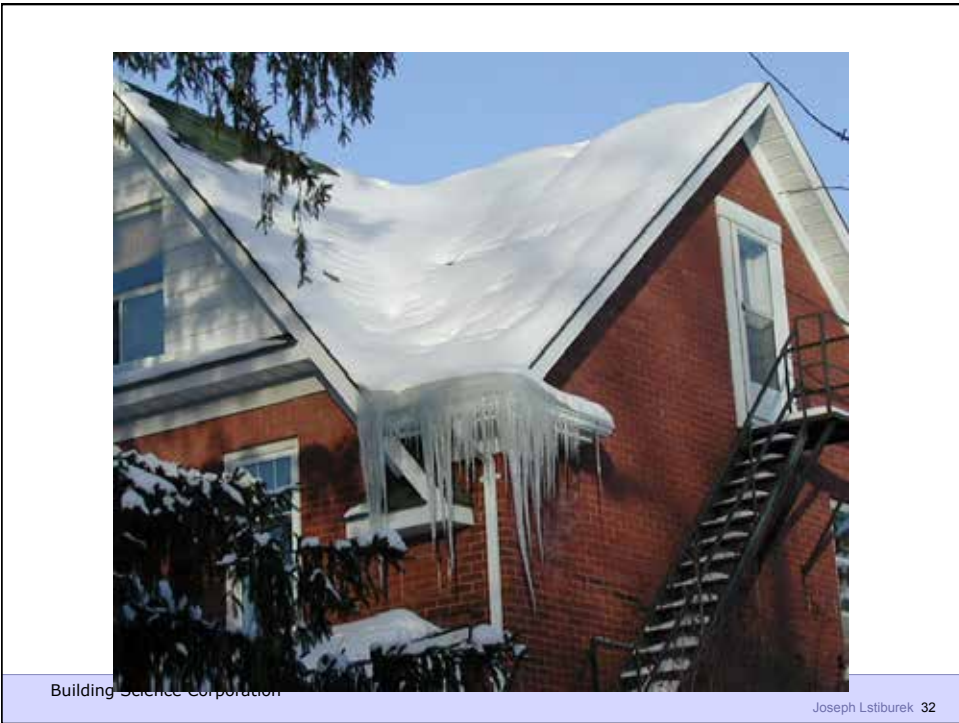
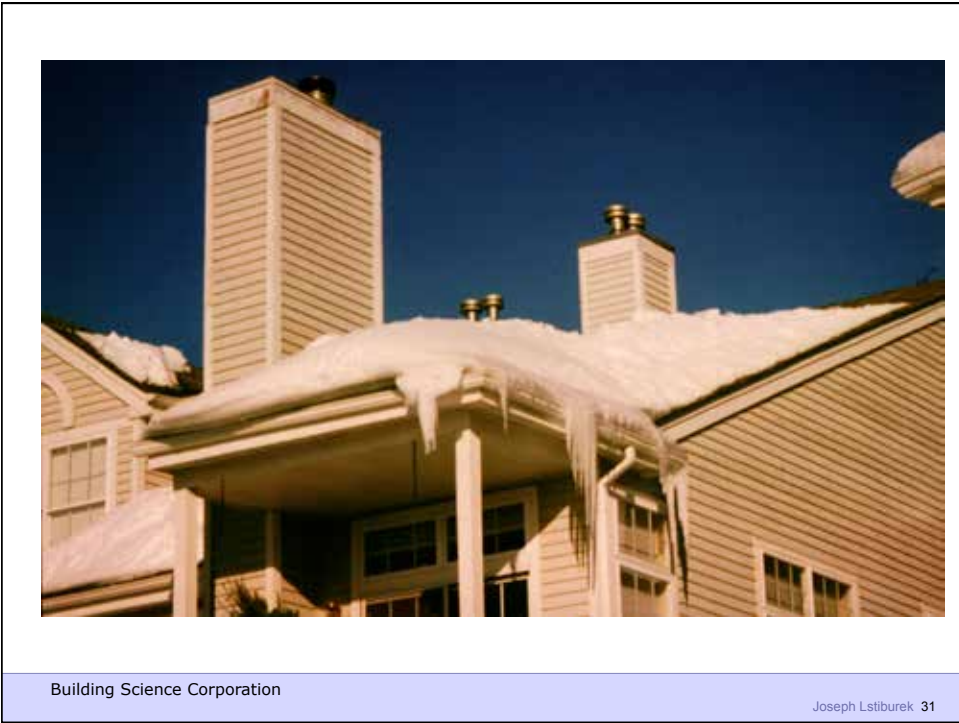

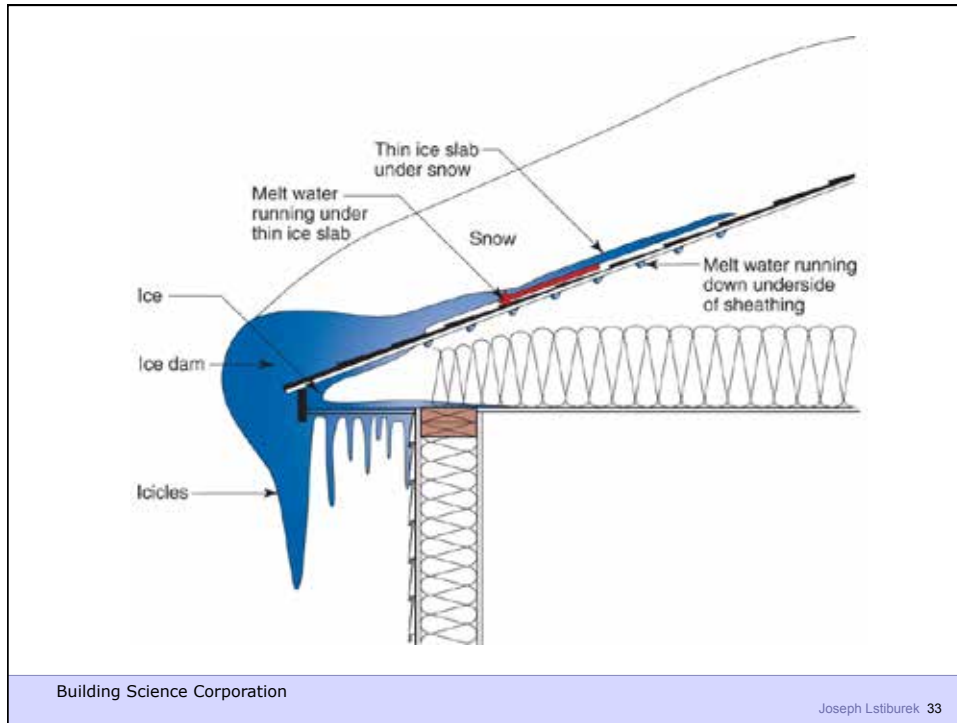

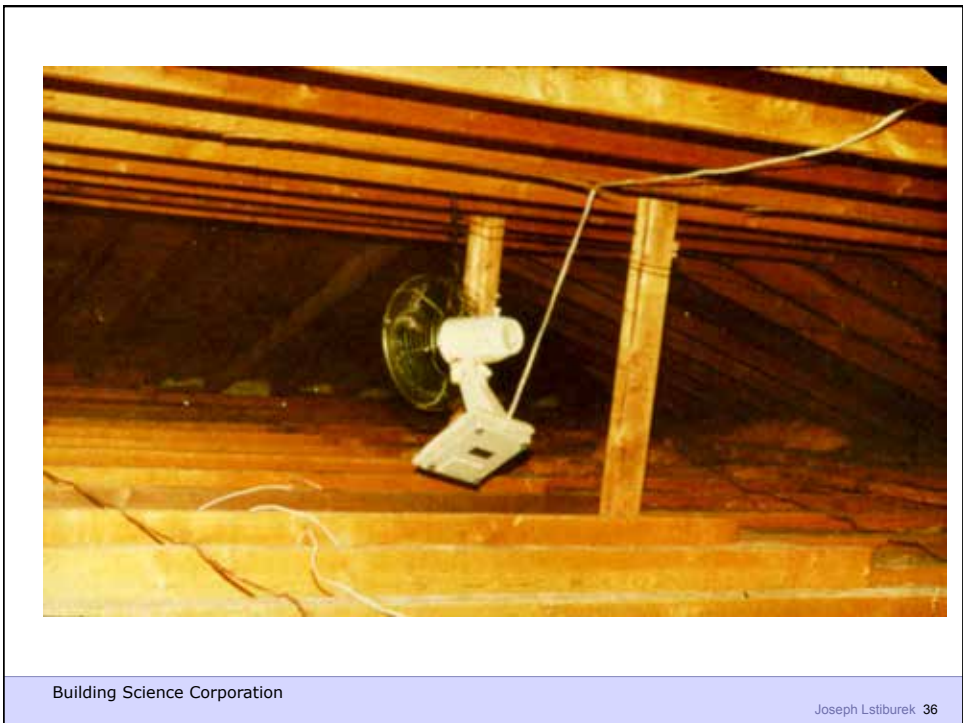



Building Science Corporation

Joseph Lstiburek 37



Building Science Corporation

Joseph Lstiburek 38



Building Science Corporation

Joseph Lstiburek 39



Building Science Corporation

Joseph Lstiburek 40

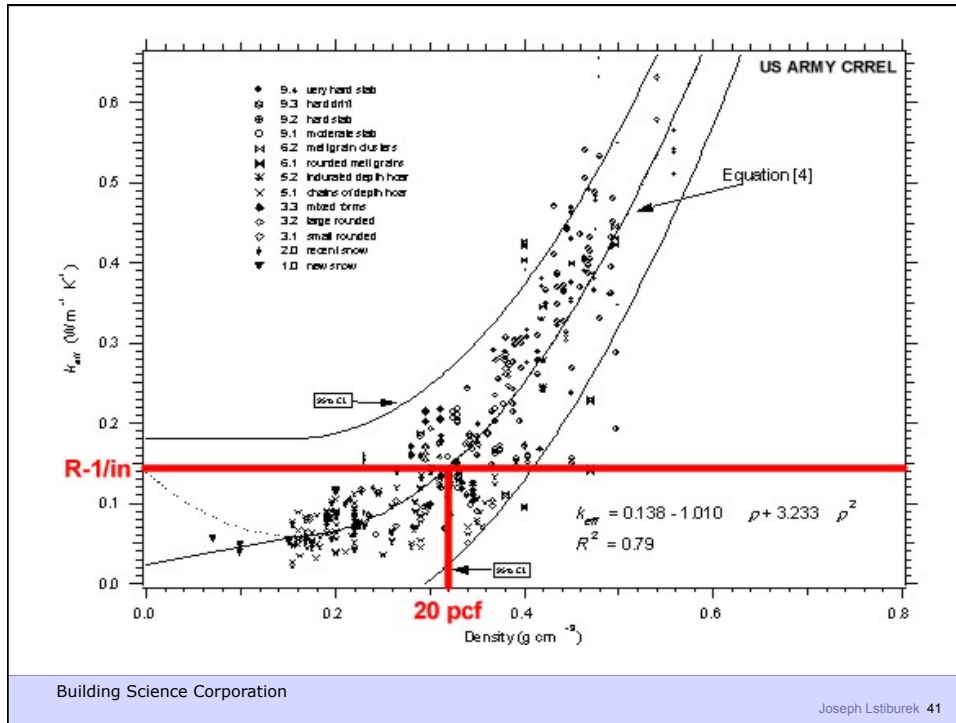



Building Science Corporation

Joseph Lstiburek 43

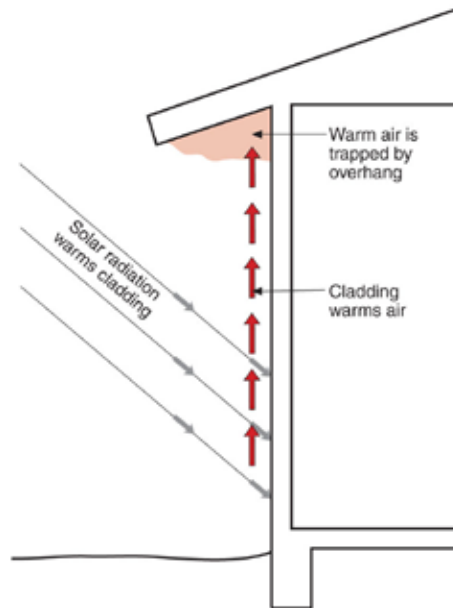

Building Science Corporation

Joseph Lstiburek 44



Building Science Corporation

Joseph Lstiburek 45



Building Science Corporation

Joseph Lstiburek 46



Building Science Corporation

Joseph Lstiburek 47



Building Science Corporation

Joseph Lstiburek 48

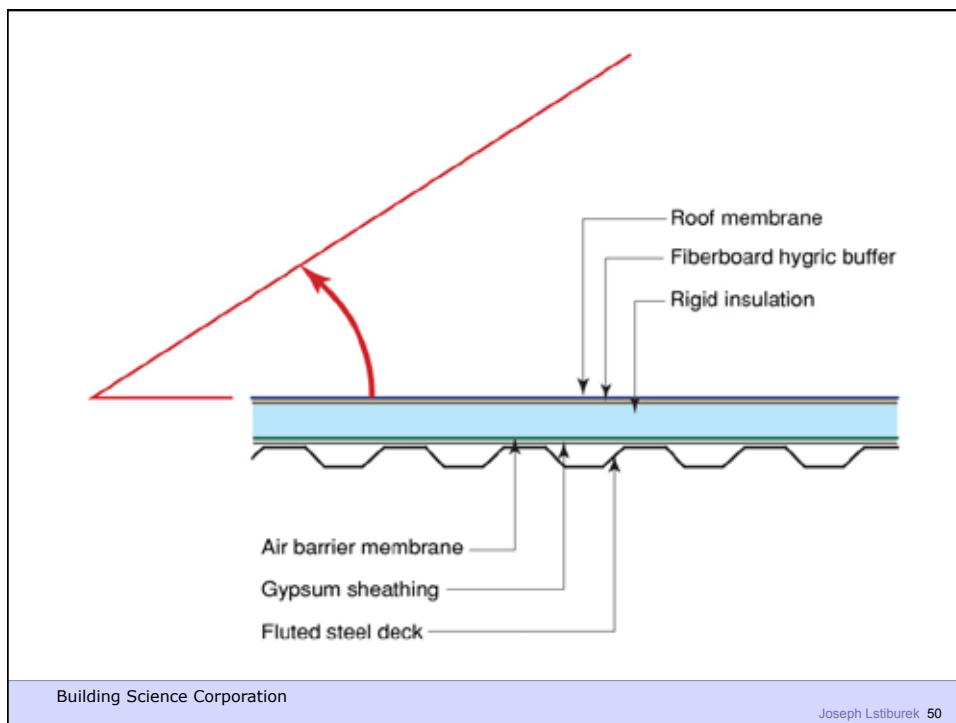
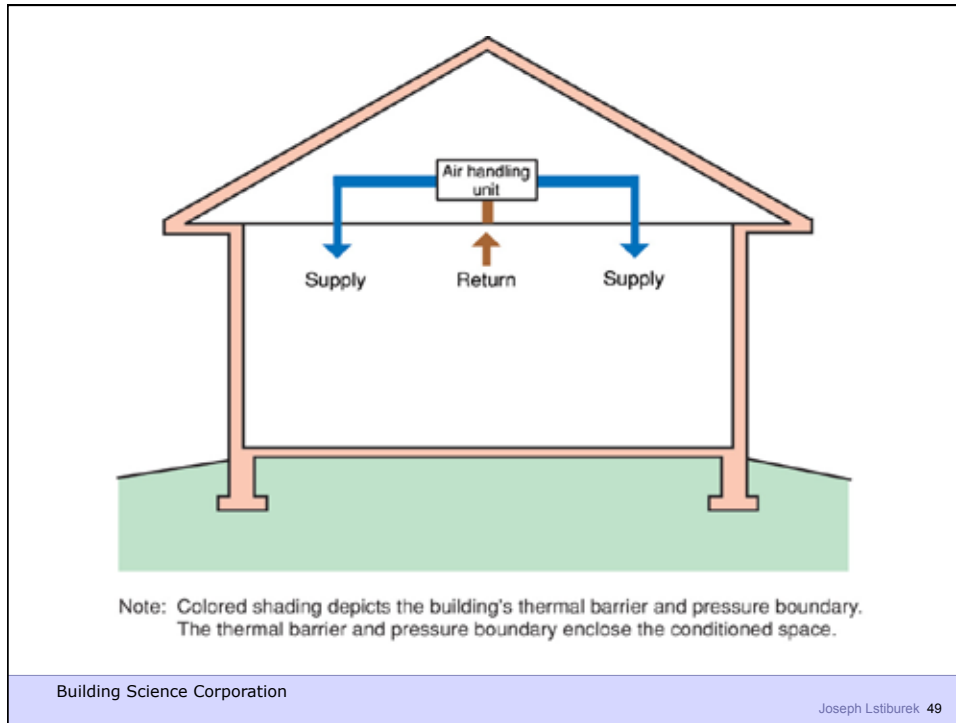

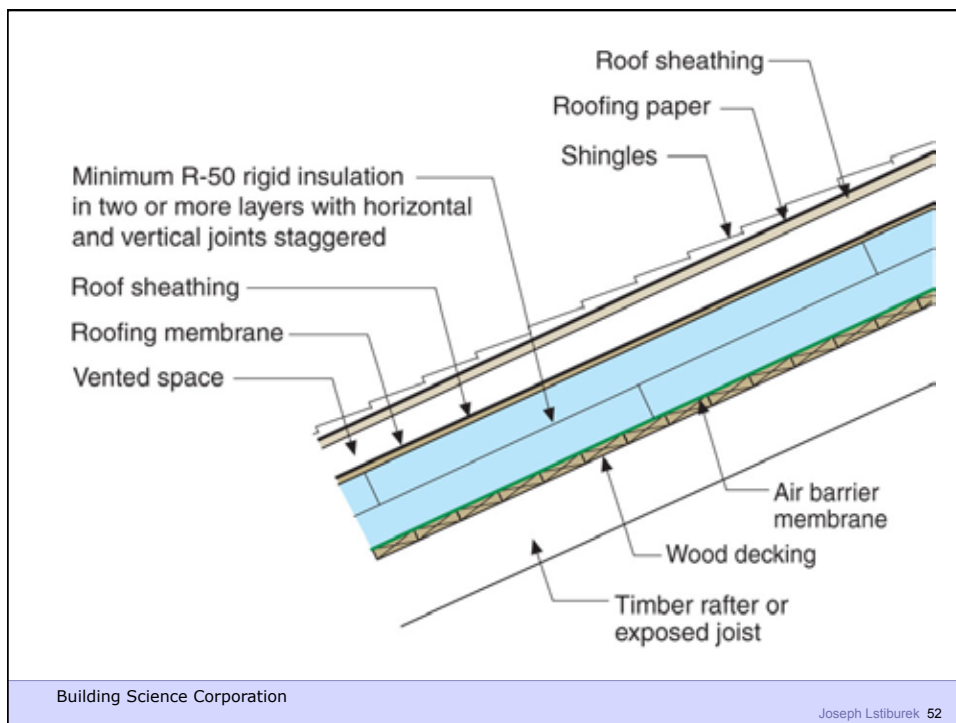
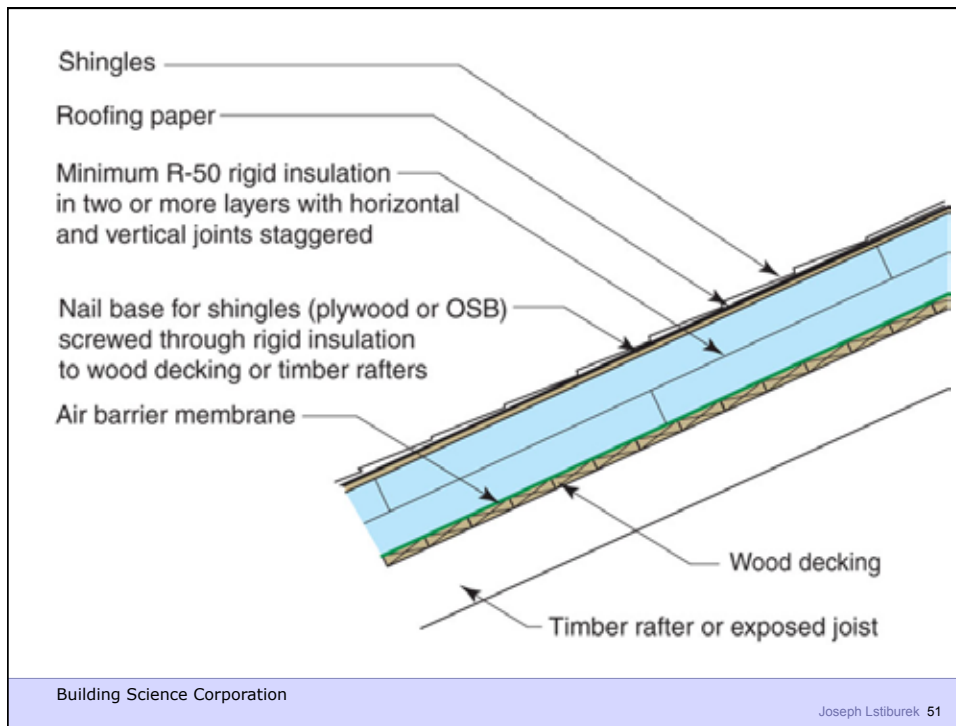

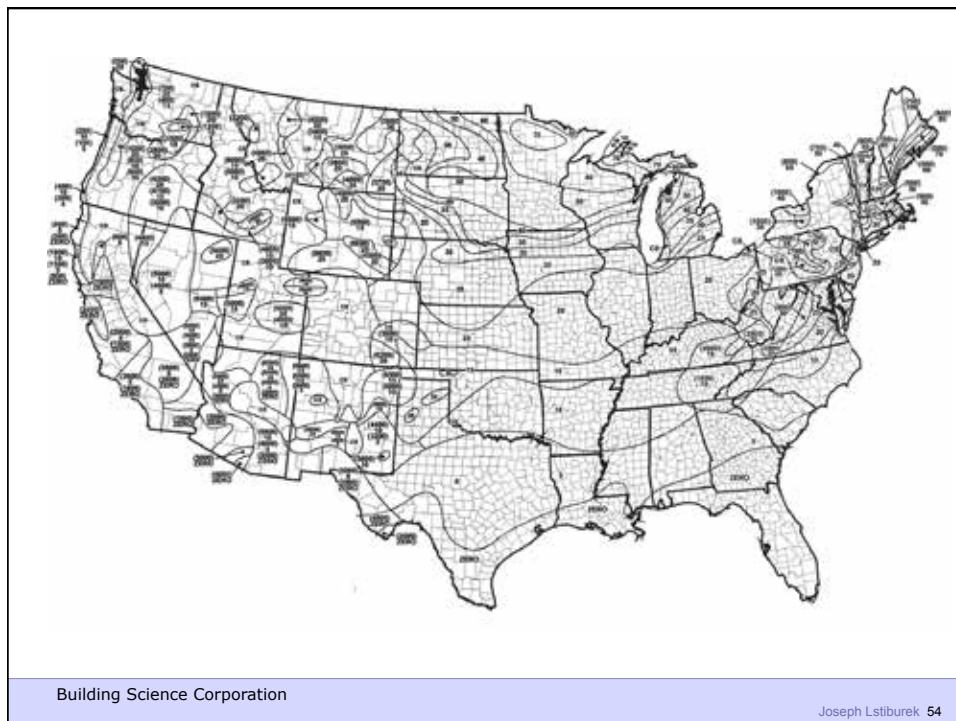
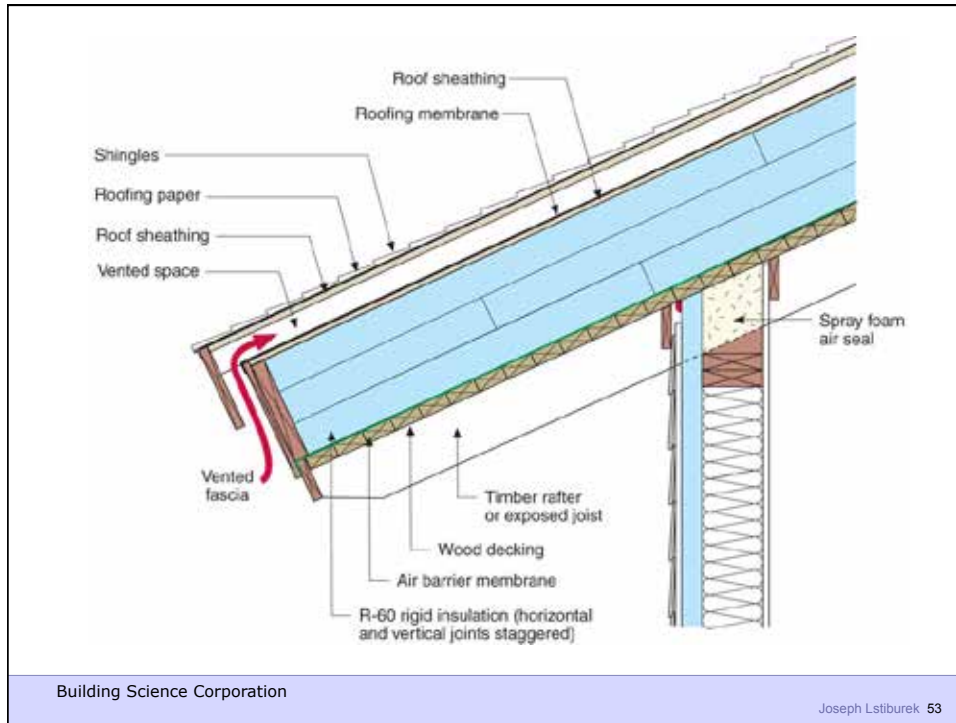



Building Science Corporation

Joseph Lstiburek 55



Building Science Corporation

Joseph Lstiburek 56



Building Science Corporation

Joseph Lstiburek 57



Building Science Corporation

Joseph Lstiburek 58



Building Science Corporation

Joseph Lstiburek 59



Building Science Corporation

Joseph Lstiburek 60



Building Science Corporation

Joseph Lstiburek 61



Building Science Corporation

Joseph Lstiburek 62



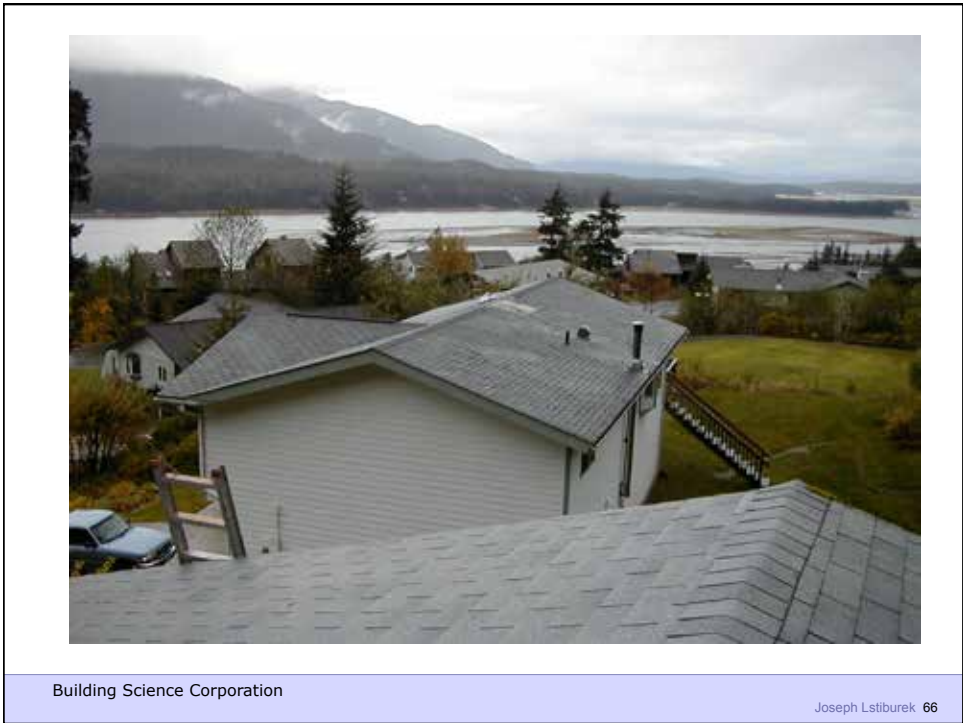



Building Science Corporation

Joseph Lstiburek 67



Building Science Corporation

Joseph Lstiburek 68



Building Science Corporation

Joseph Lstiburek 69



Building Science Corporation

Joseph Lstiburek 70

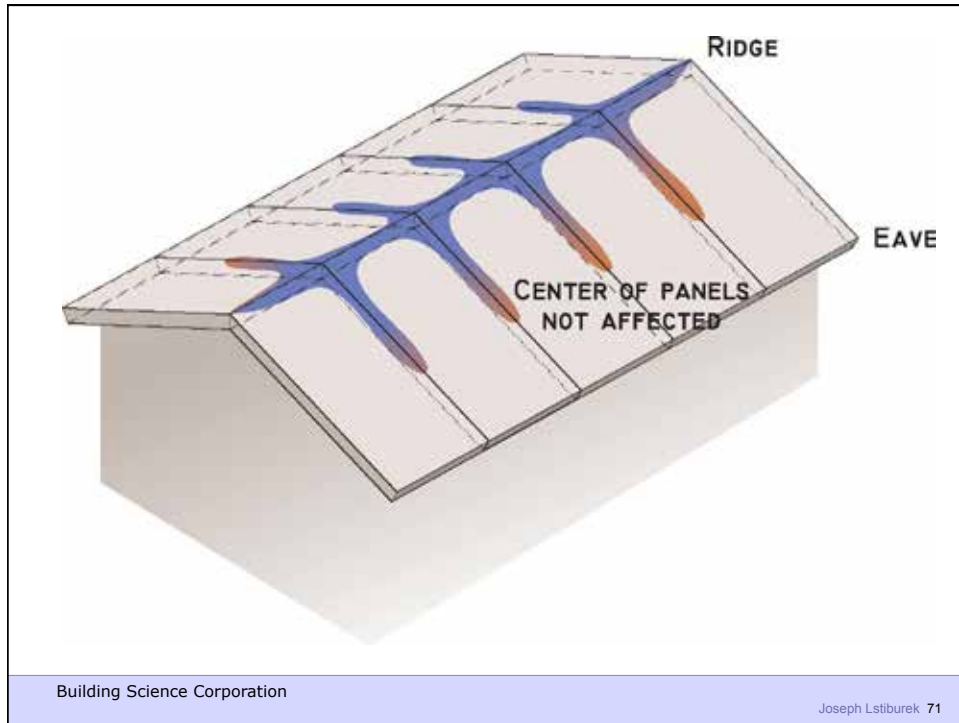

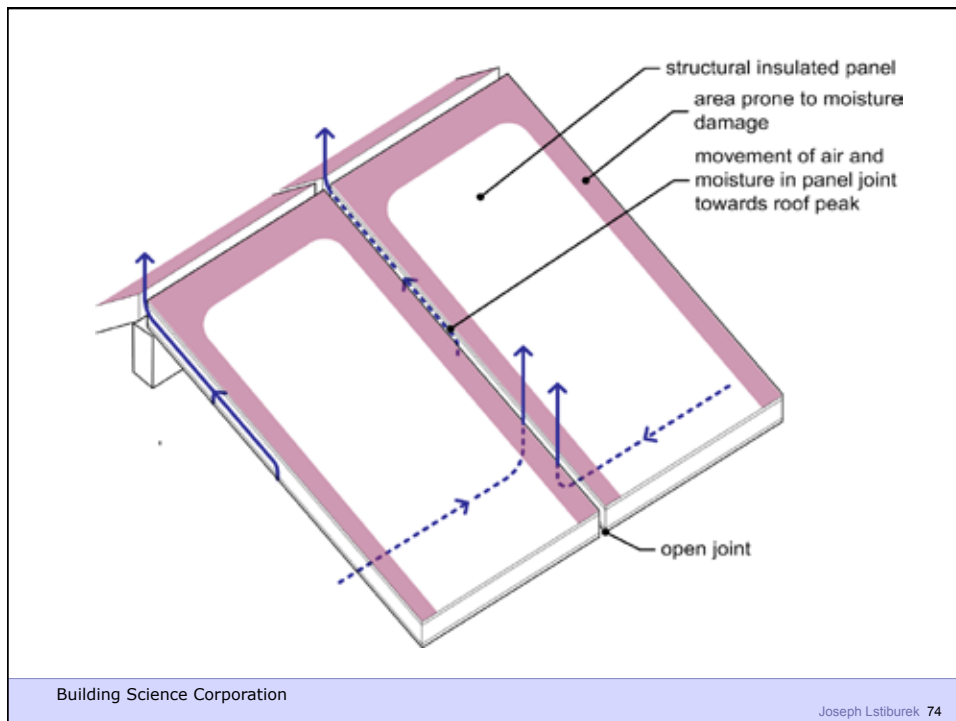
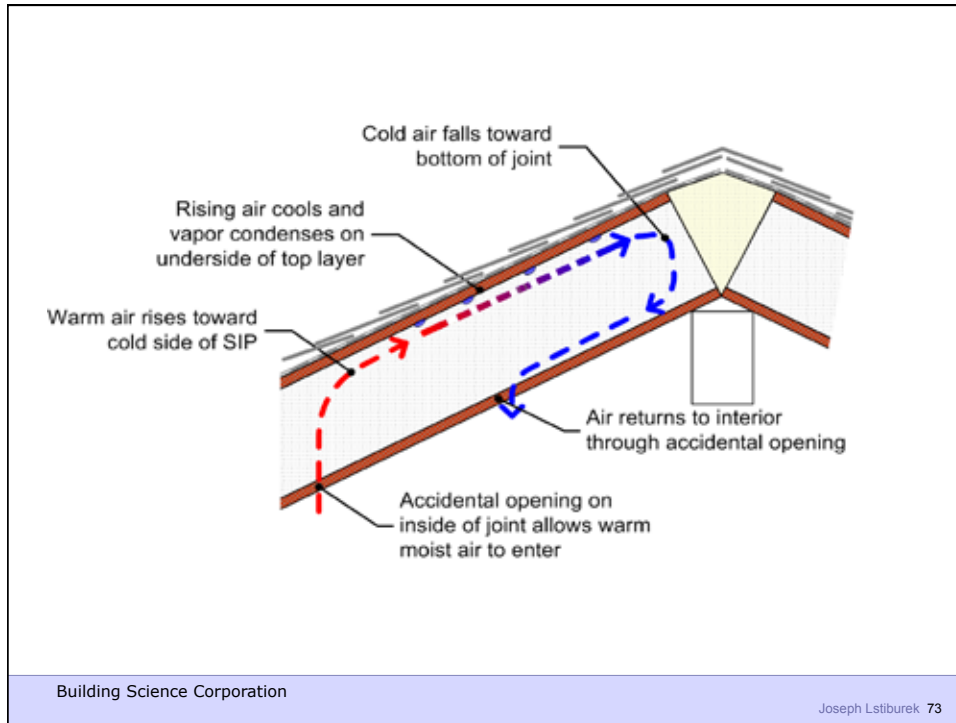

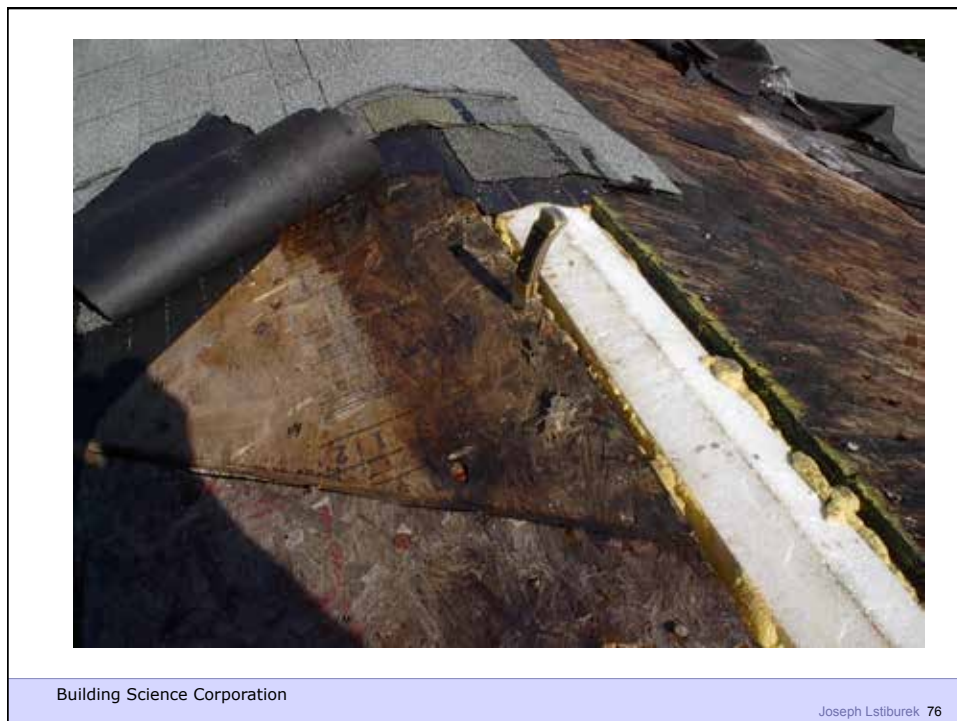
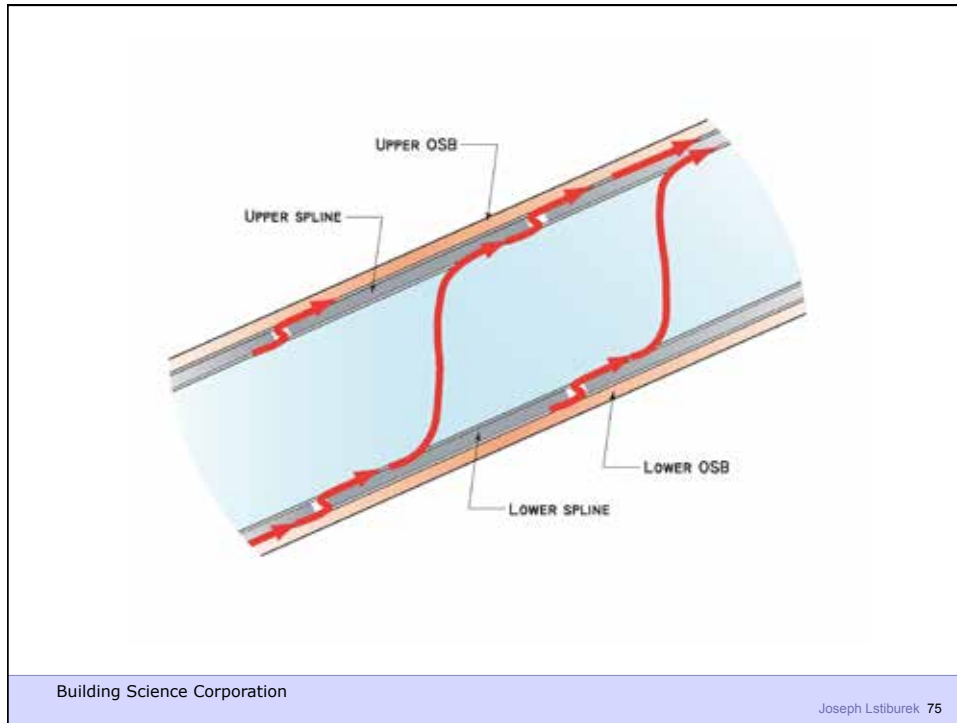





Building Science Corporation

Joseph Lstiburek 79



Building Science Corporation

Joseph Lstiburek 80



Building Science Corporation

Joseph Lstiburek 81



Building Science Corporation

Joseph Lstiburek 82

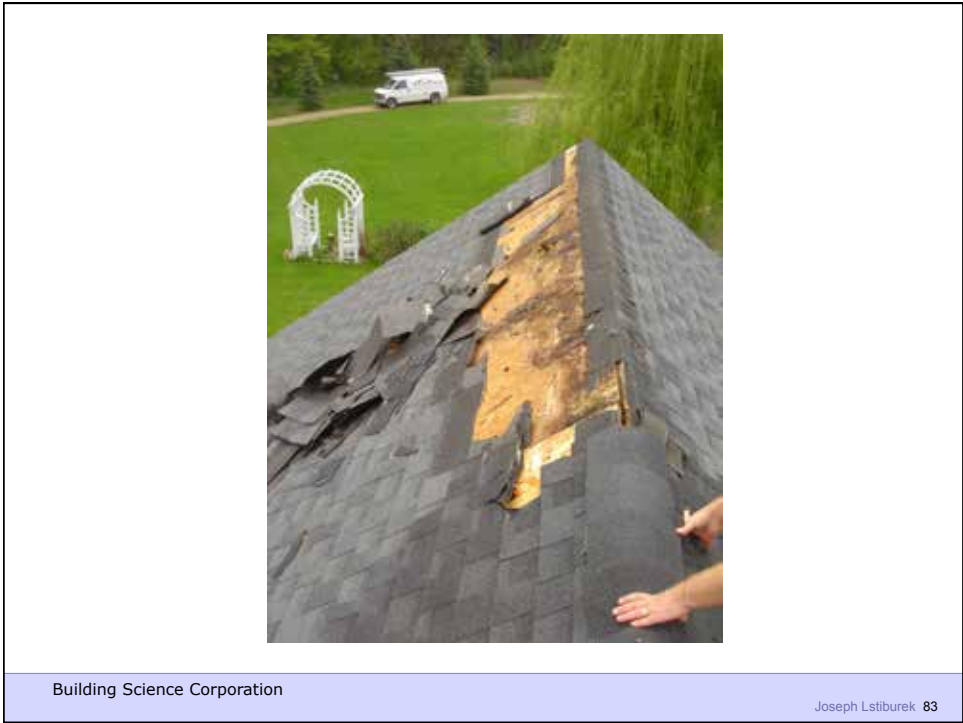

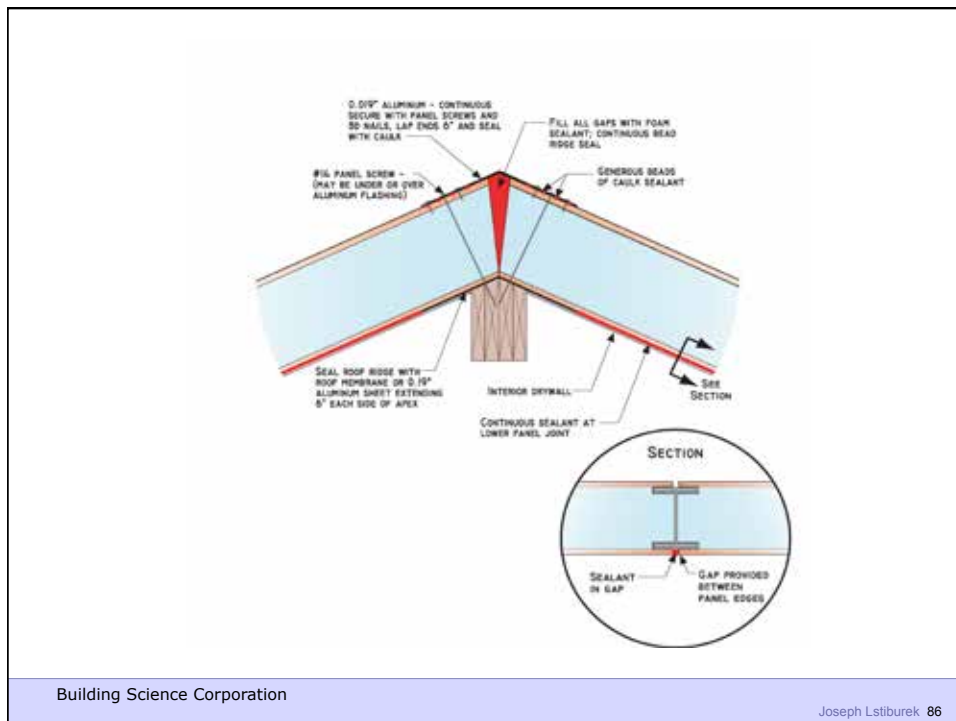
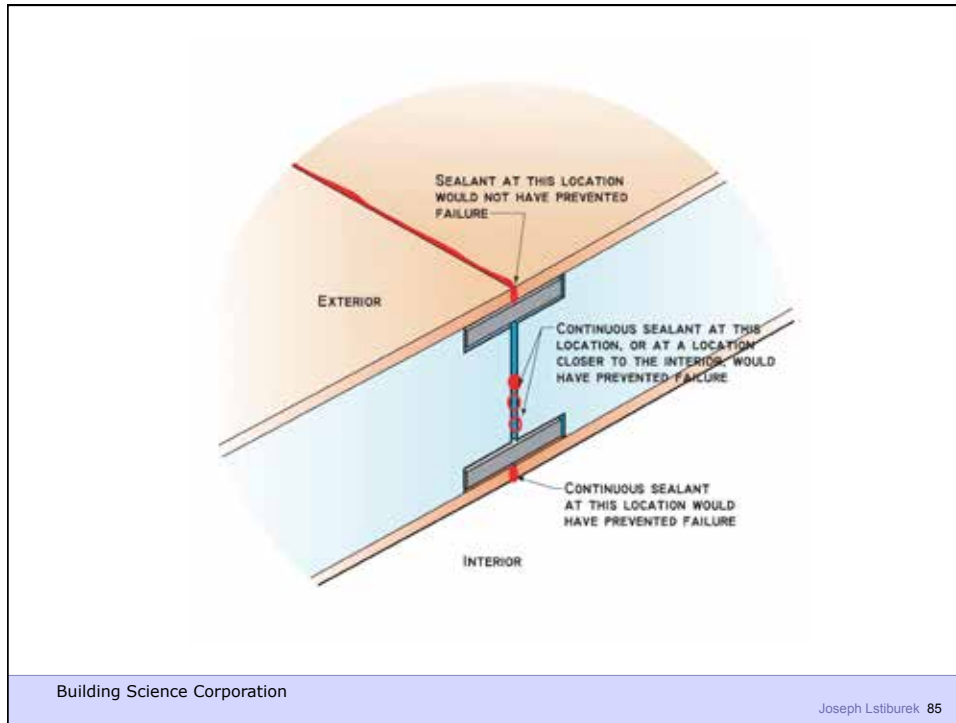



Building Science Corporation

Joseph Lstiburek 87



Building Science Corporation

Joseph Lstiburek 88





Building Science Corporation

Joseph Lstiburek 91



Building Science Corporation

Joseph Lstiburek 92

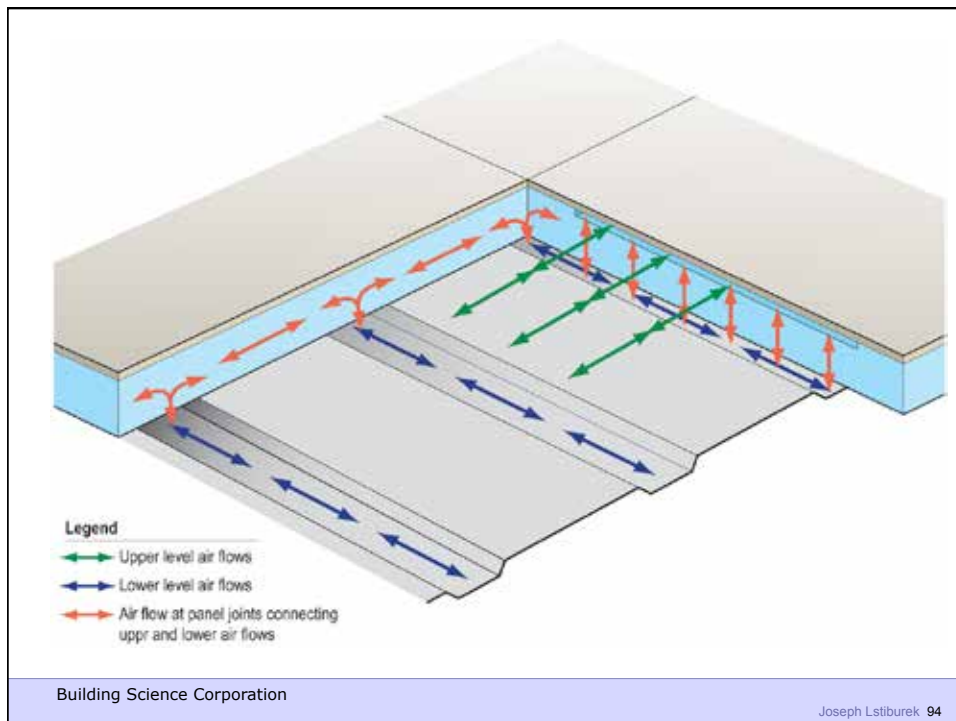
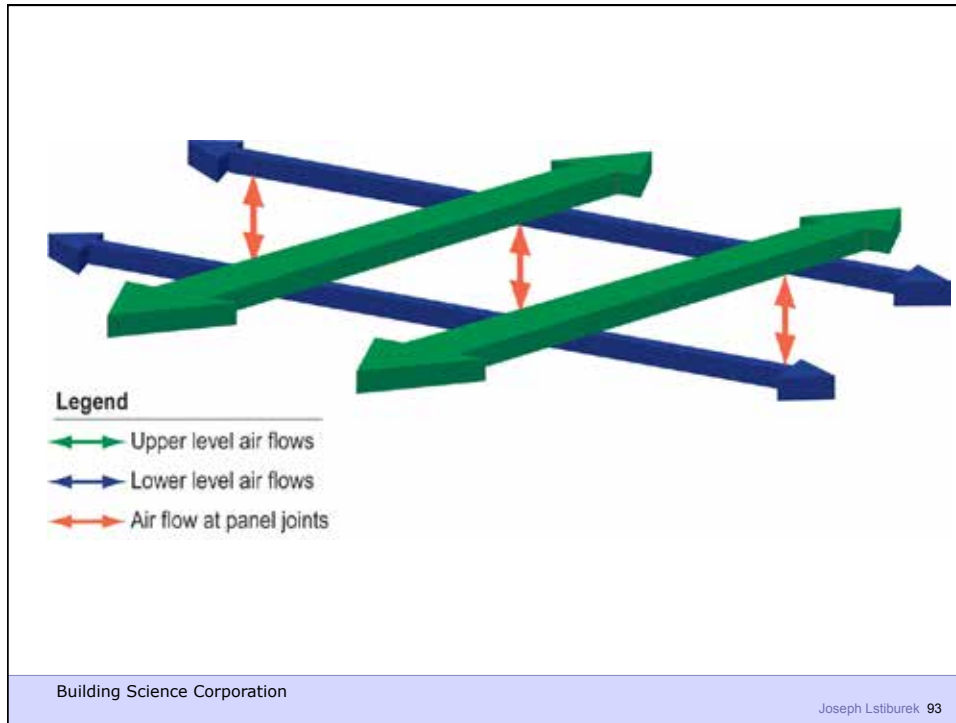

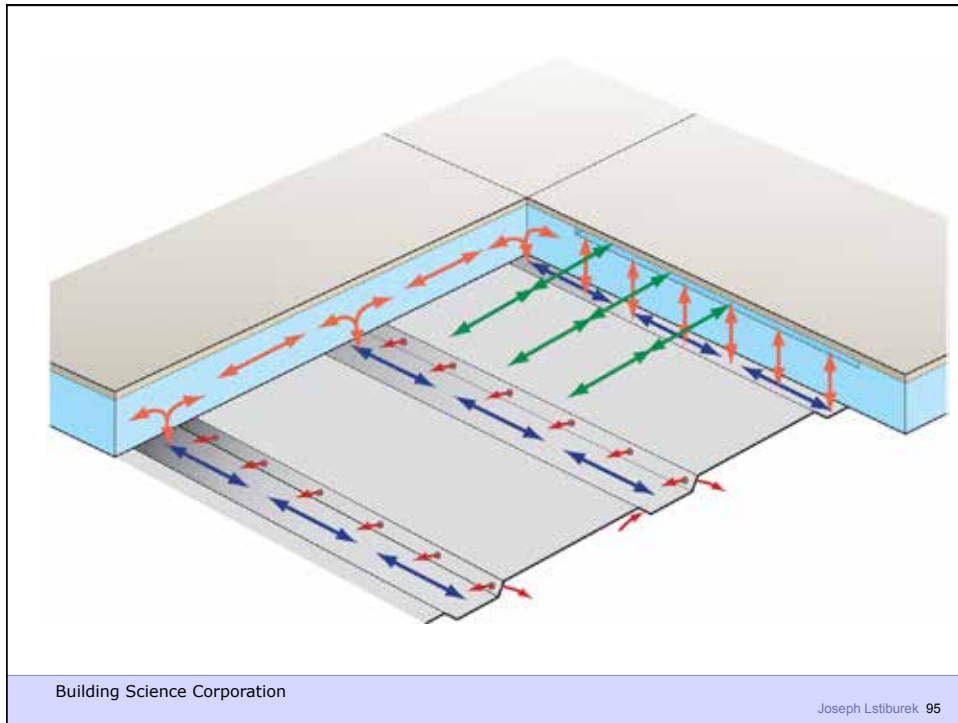

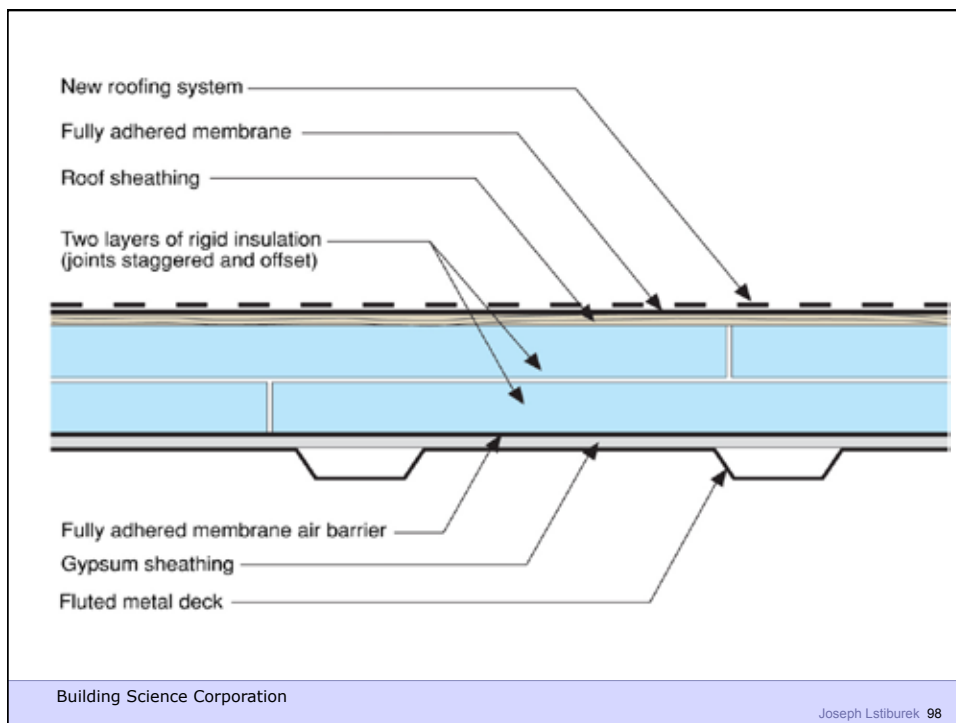
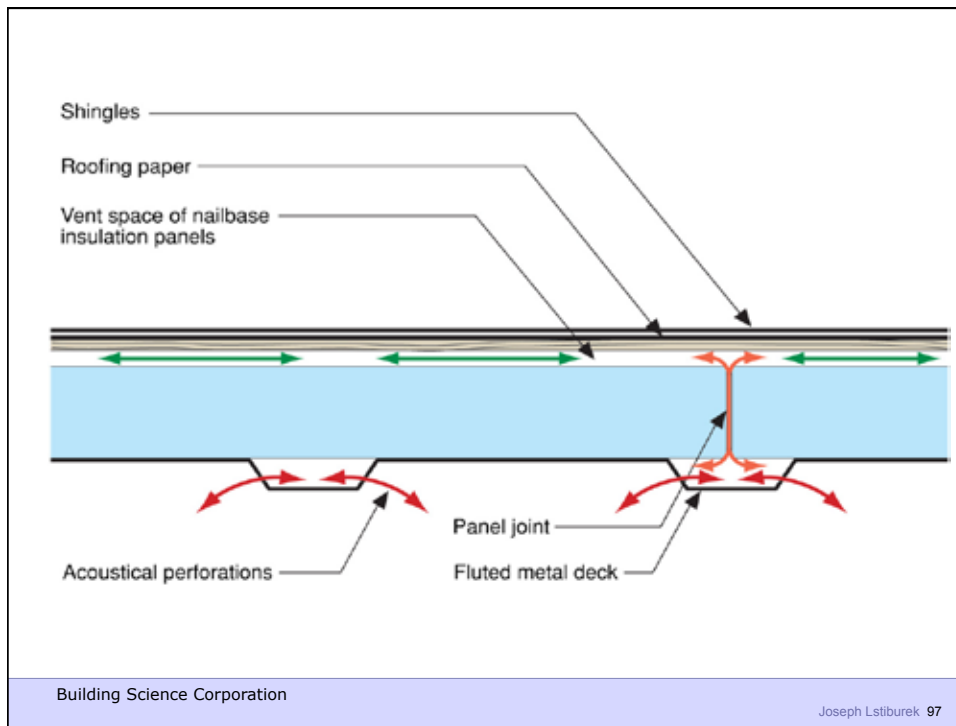

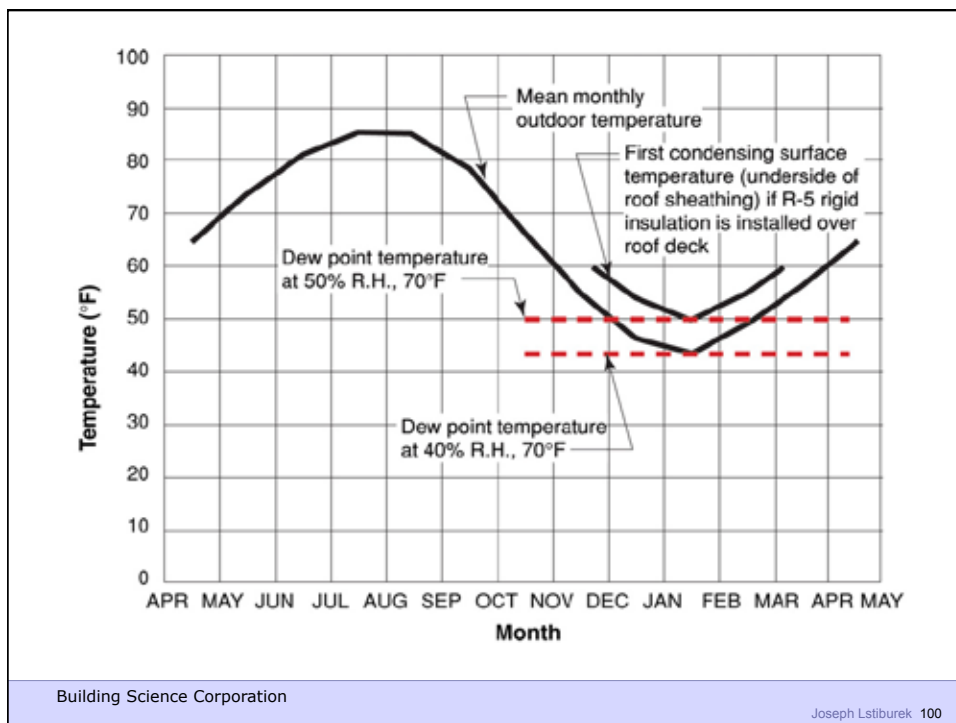
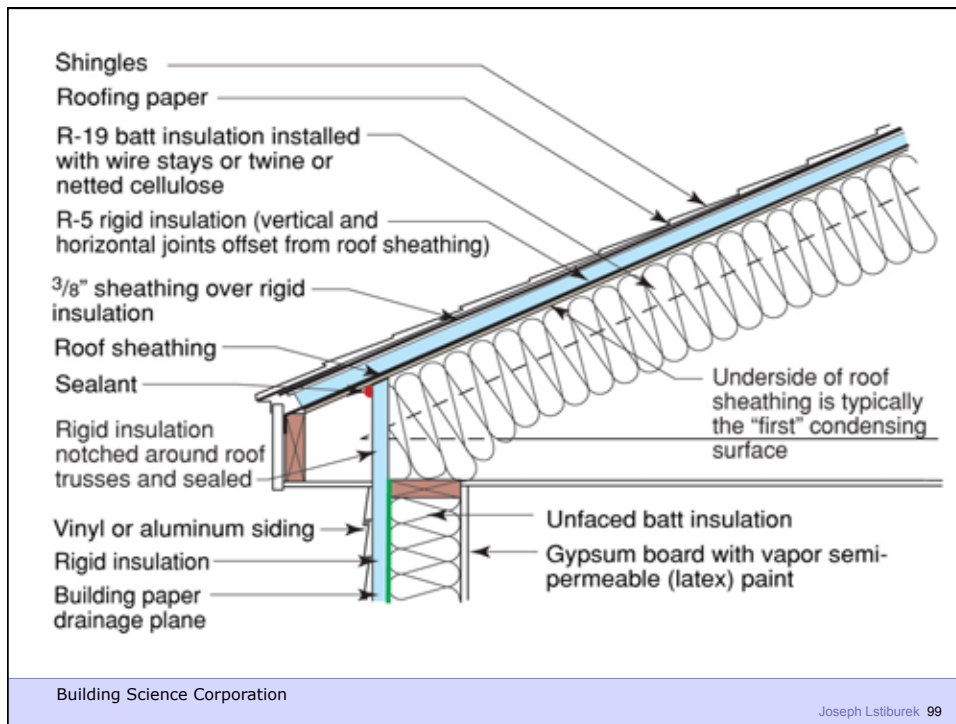

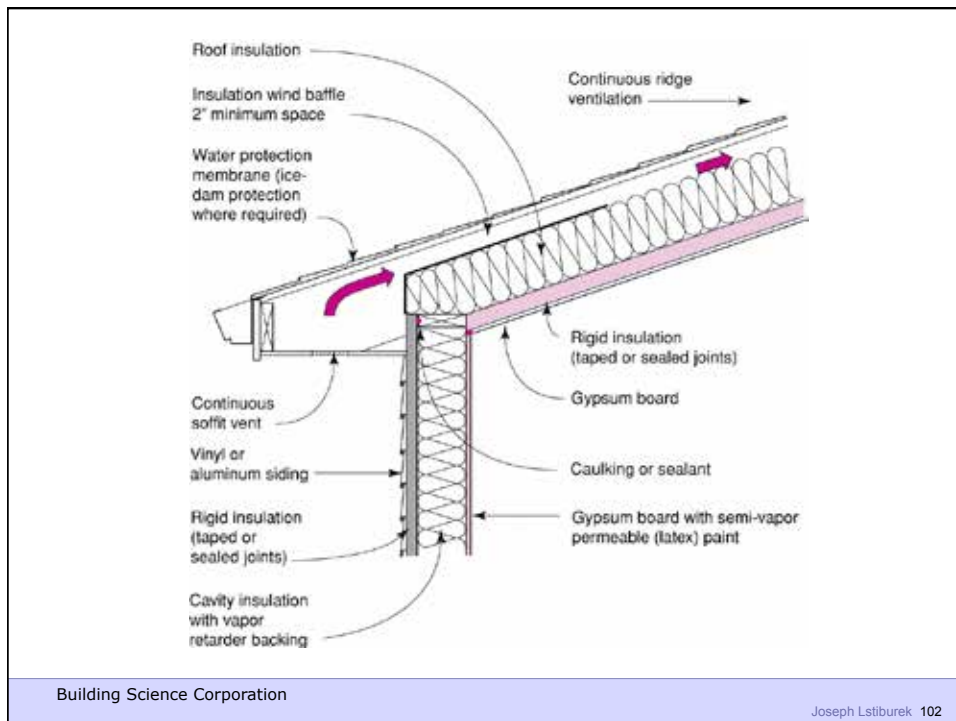
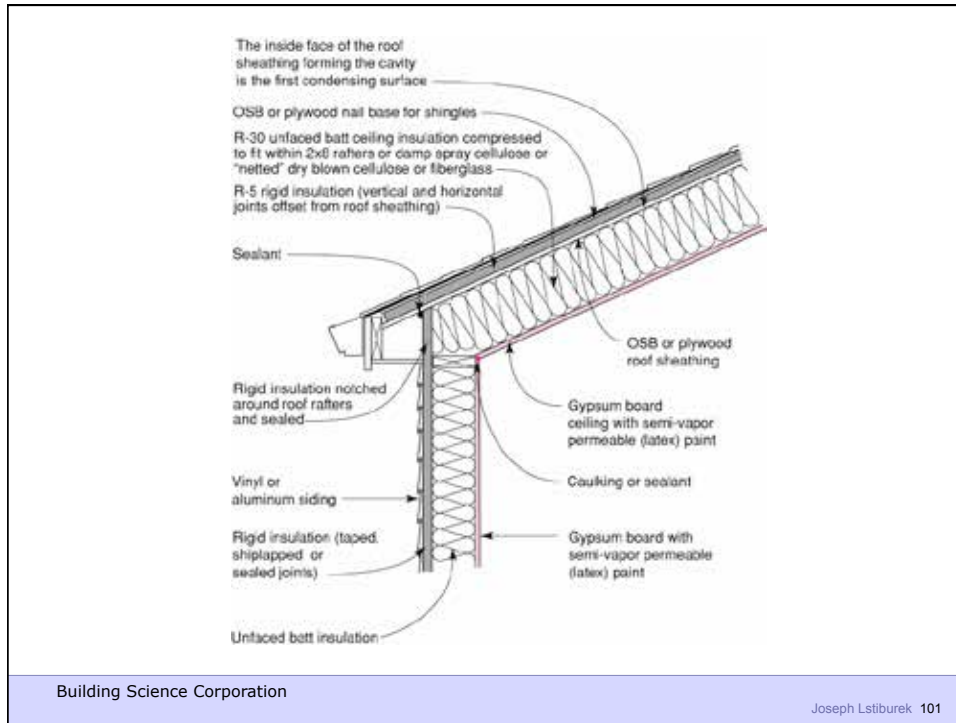

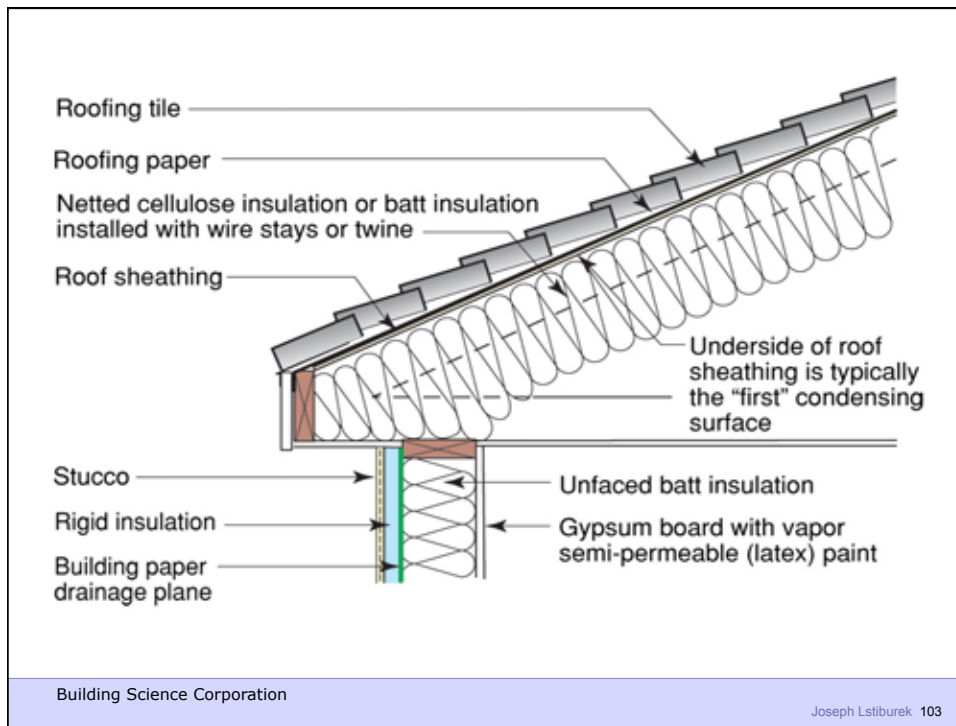



Building Science Corporation

Joseph Lstiburek 105



Building Science Corporation

Joseph Lstiburek 106

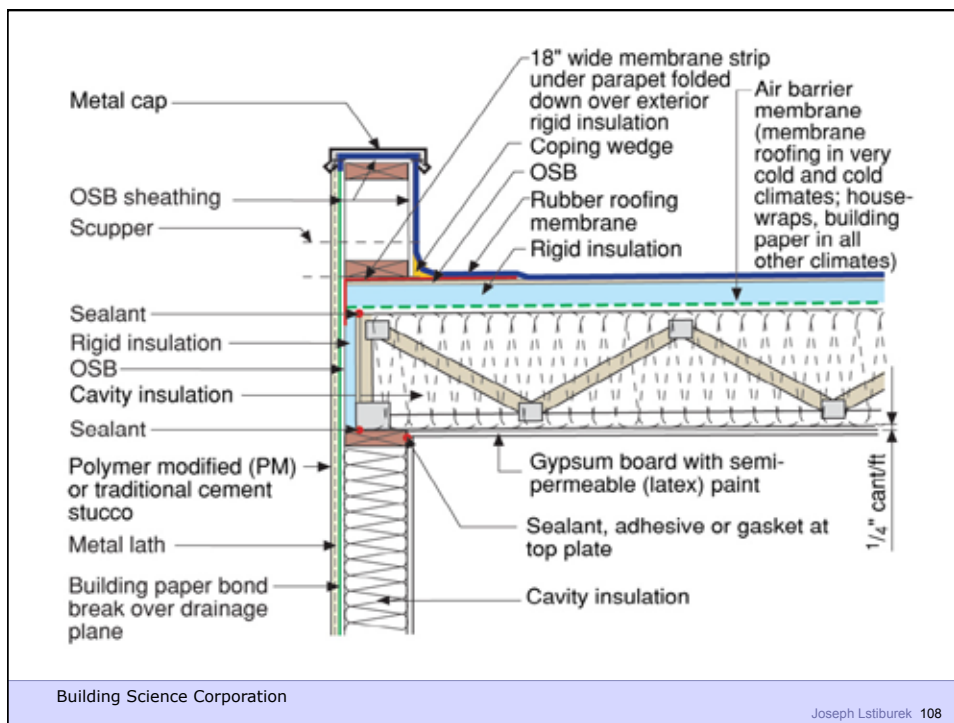
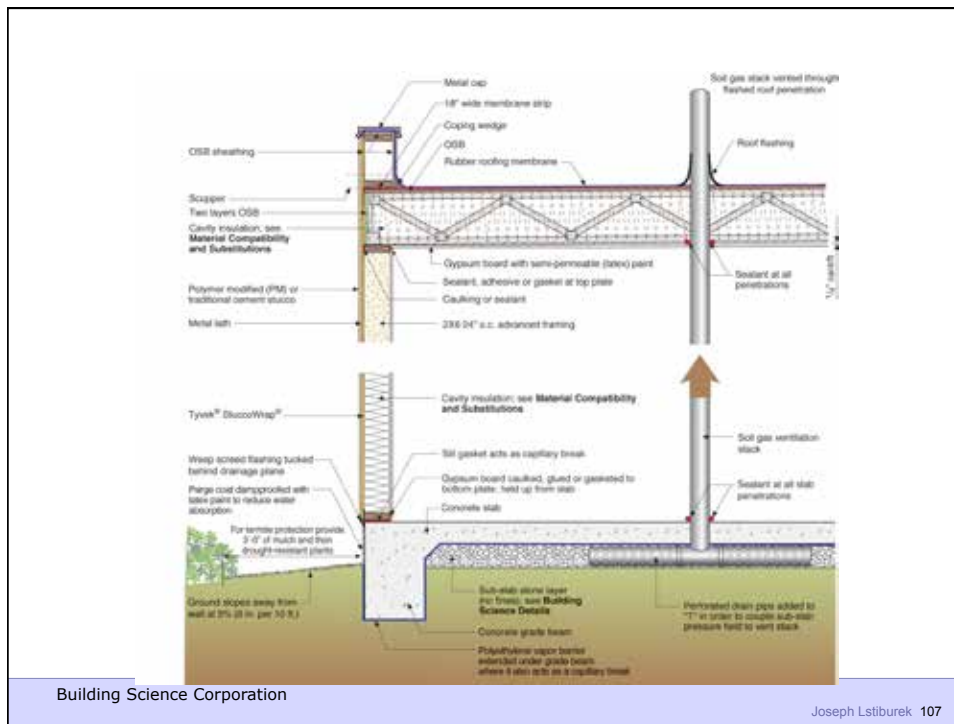

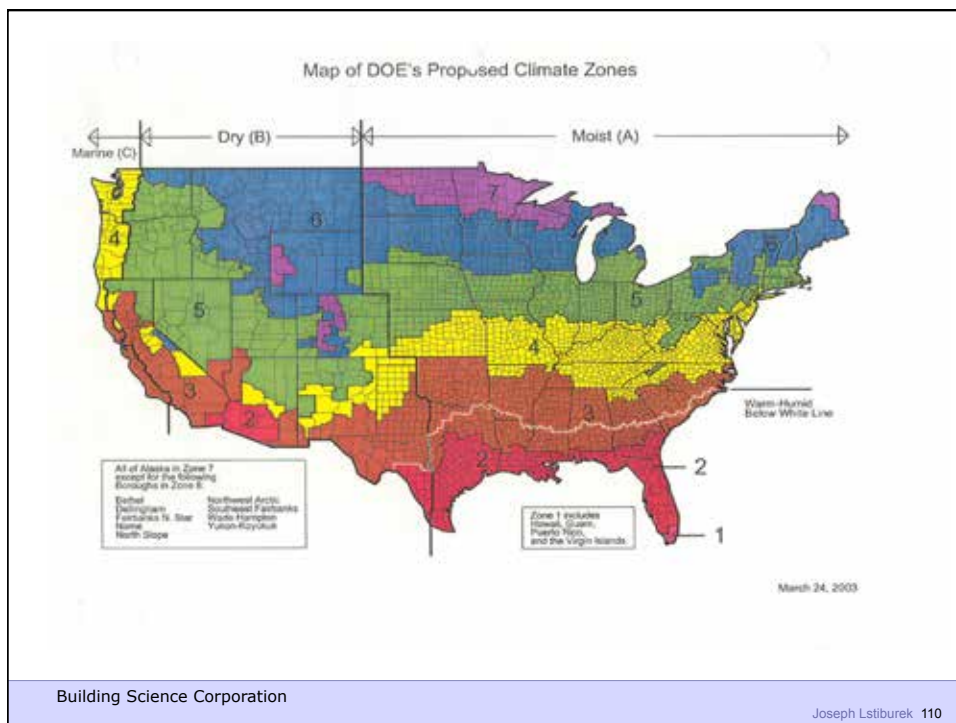
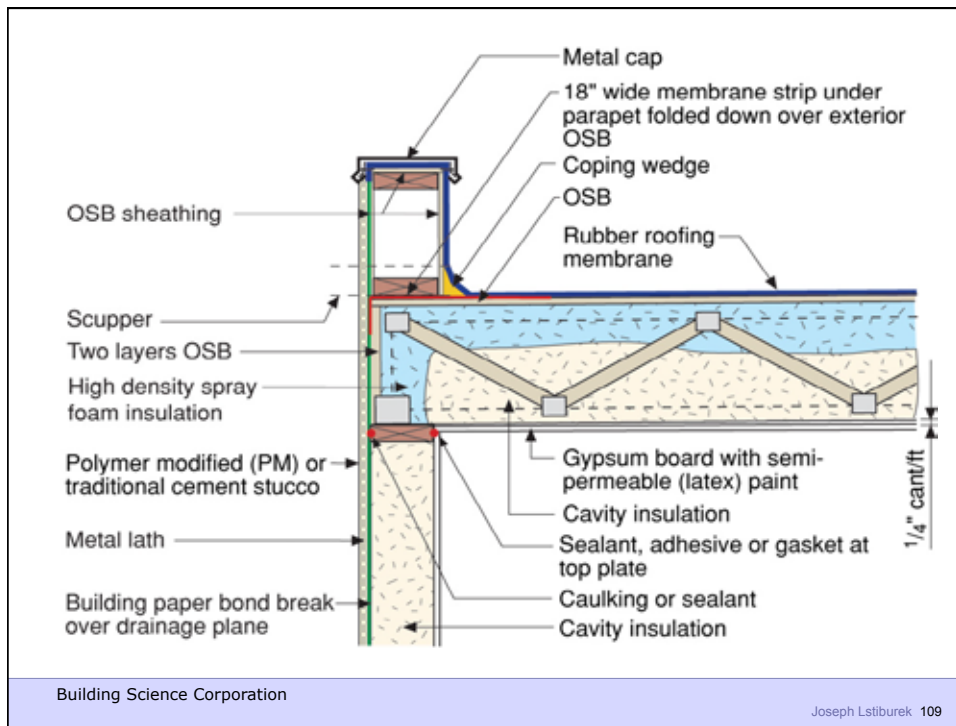

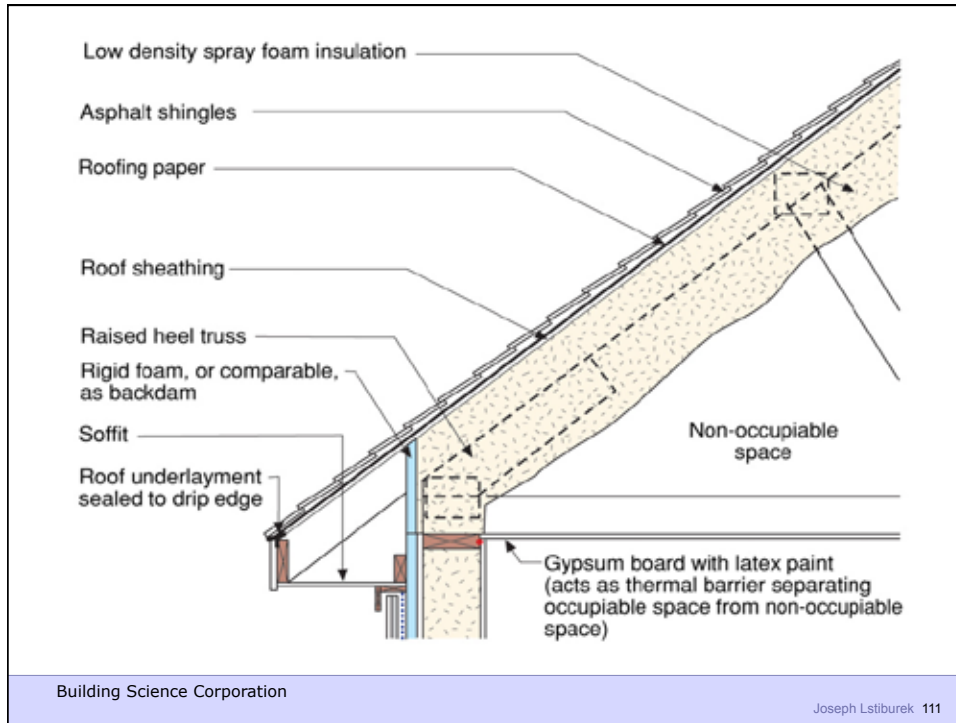

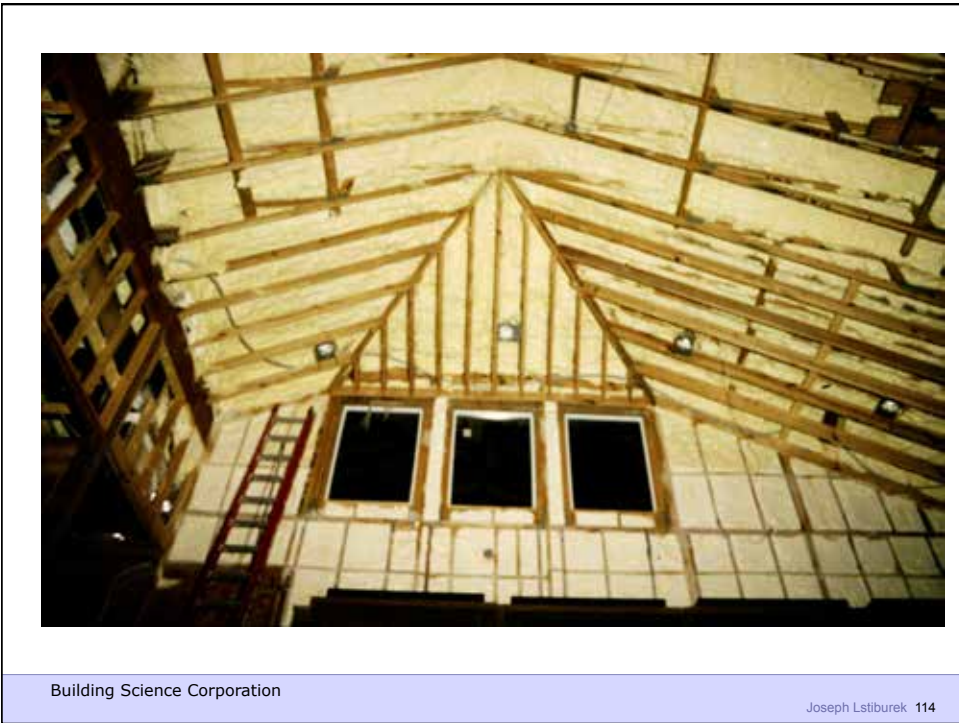
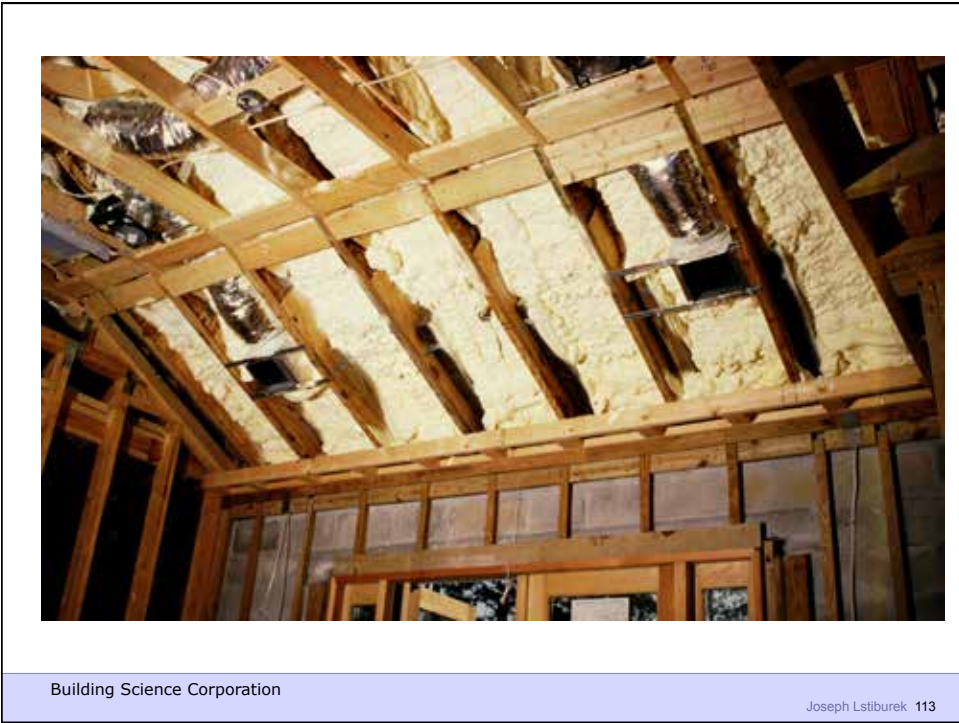

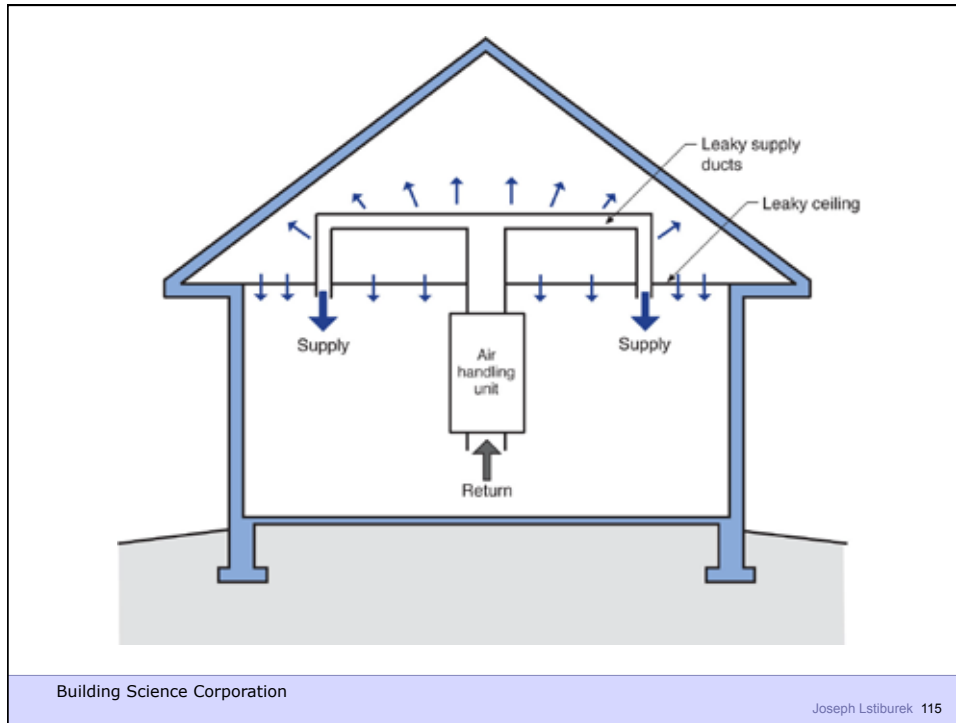



Building Science Corporation

Joseph Lstiburek 117



Building Science Corporation

Joseph Lstiburek 118



Building Science Corporation

Joseph Lstiburek 119



Building Science Corporation

Joseph Lstiburek 120



Building Science Corporation

Joseph Lstiburek 121



Building Science Corporation

Joseph Lstiburek 122



Building Science Corporation

Joseph Lstiburek 123