

Dilution Is Not The Solution To Indoor Pollution

Joseph Lstiburek, Ph.D., P.Eng.

Build Tight – Ventilate Right

- How Tight?
- What's Right?

Air Barrier Metrics

- Material 0.02 l/(s-m²) @ 75 Pa
- Assembly 0.20 l/(s-m²) @ 75 Pa
- Enclosure 2.00 l/(s-m²) @ 75 Pa

Air Barrier Metrics

- Material 0.02 l/(s-m²) @ 75 Pa
- Assembly 0.20 l/(s-m²) @ 75 Pa
- Enclosure 2.00 l/(s-m²) @ 75 Pa
- 0.25 cfm/ft² @ 50 Pa

- Getting Rid of Big Holes 3 ach @ 50 Pa
- Getting Rid of Smaller Holes 1.5 ach @ 50 Pa
- Getting German 0.6 ach @ 50 Pa

The Cult Of The Blower Door



IAQ & Energy 2018

- A Blower Door Can't Get You The True ACH On A Short Term Basis – Hour, Day, Week

- Don't Know Where The Holes Are
- Don't Know The Type Of Holes
- Don't Know The Pressure Across The Holes
- Galactically Stupid Assumption of Single Well Mixed Zone

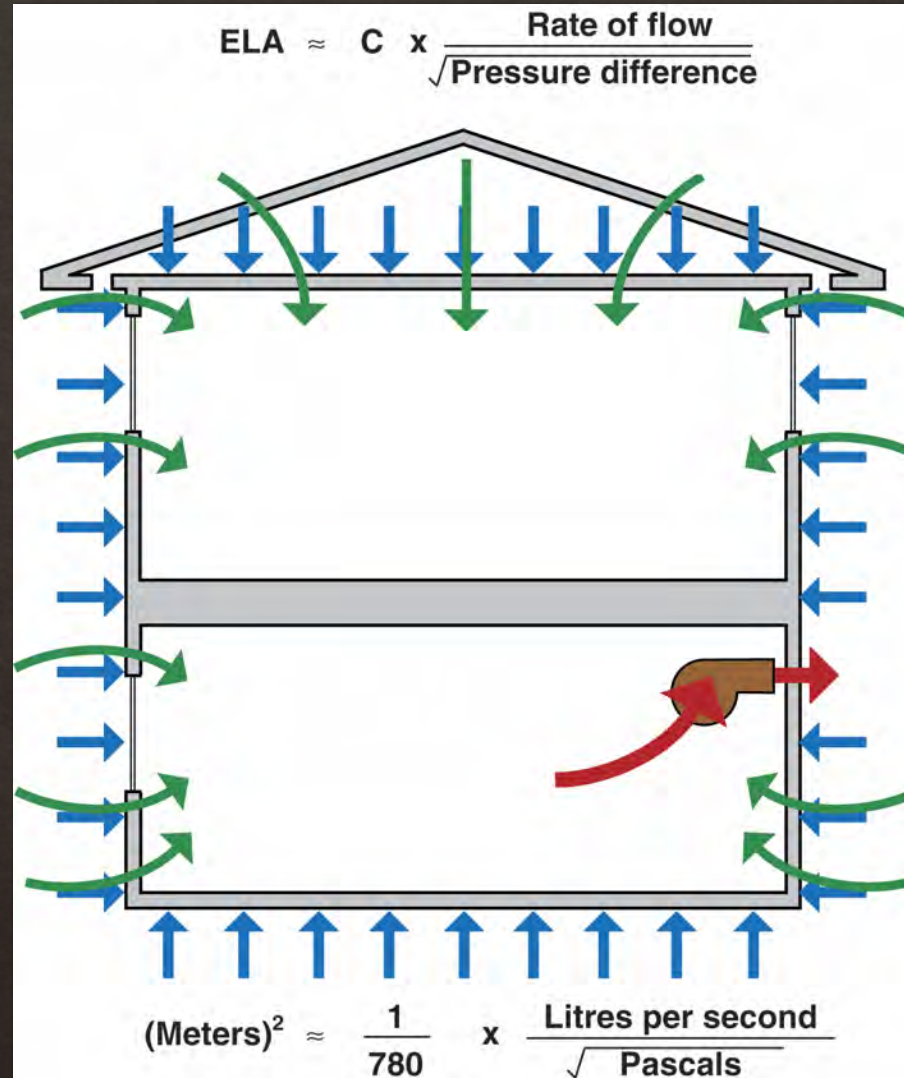

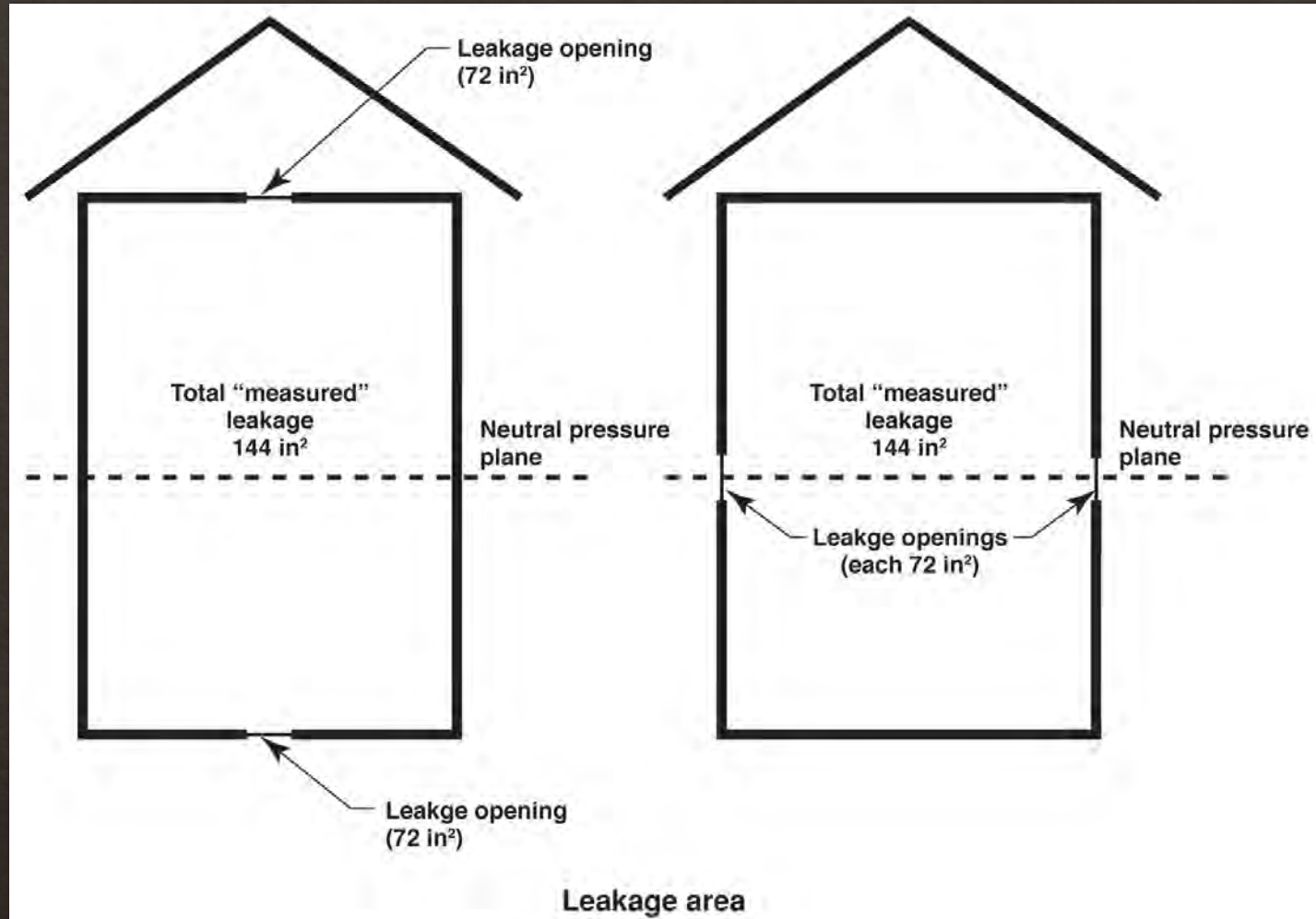

- A Blower Door Can't Get You The True ACH On A Short Term Basis – Hour, Day, Week
- But If You Take A Long Enough Time Interval The Average Air Change Predictions Are Not That Obscenely Bad...

- The Big Lie Used To Try To Justify The Lack Of Short Term Accuracy Is To Argue That Annual Exposure To Contaminants Is The Key Basis To Determine Risk And Therefore Average Annual Air Change Rates Are The Correct Metrics...

- Everywhere Else On The Planet Where Adults Are Involved The Approach Is To Get Rid Of The Big Holes....And Realize That The Small Holes Don't Matter....And Therefore Give No Credit For "Natural Air Change" ...And...Wait For It....Require Controlled Ventilation Without An "Infiltration Credit" Based On Galactically Stupid Assumptions, Bad Physics And A Blower.

- But There Is Good Money To Be Made Doing Unnecessary Testing

- So What Good Is A Blower Door?

- It Is A Great Training Tool To Teach Unskilled People About Holes

- It Is A Great Training Tool To Teach Unskilled People About Holes
- It Is A Great Tool For Rating Homes For Average Annual Energy Consumption

- It Is A Great Training Tool To Teach Unskilled People About Holes
- It Is A Great Tool For Rating Homes For Average Annual Energy ConsumptionActual Mileage May Vary

- It Is A Great Training Tool To Teach Unskilled People About Holes
- It Is A Great Tool For Rating Homes For Average Annual Energy ConsumptionActual Mileage May Vary
- And When Coupled With An IR Camera It Can Help Find Holes

Ventilation Rates

- Ventilation Rates Are Based On Odor Control

- Ventilation Rates Are Based On Odor Control
- Health Science Basis For Ventilation Rates Is Extremely Limited

- Ventilation Rates Are Based On Odor Control
- Health Science Basis For Ventilation Rates Is Extremely Limited
- Almost Nothing Cited Applies To Housing

- Ventilation Rates Are Based On Odor Control
- Health Science Basis For Ventilation Rates Is Extremely Limited
- Almost Nothing Cited Applies To Housing
- The Applicable Studies Focus On Dampness

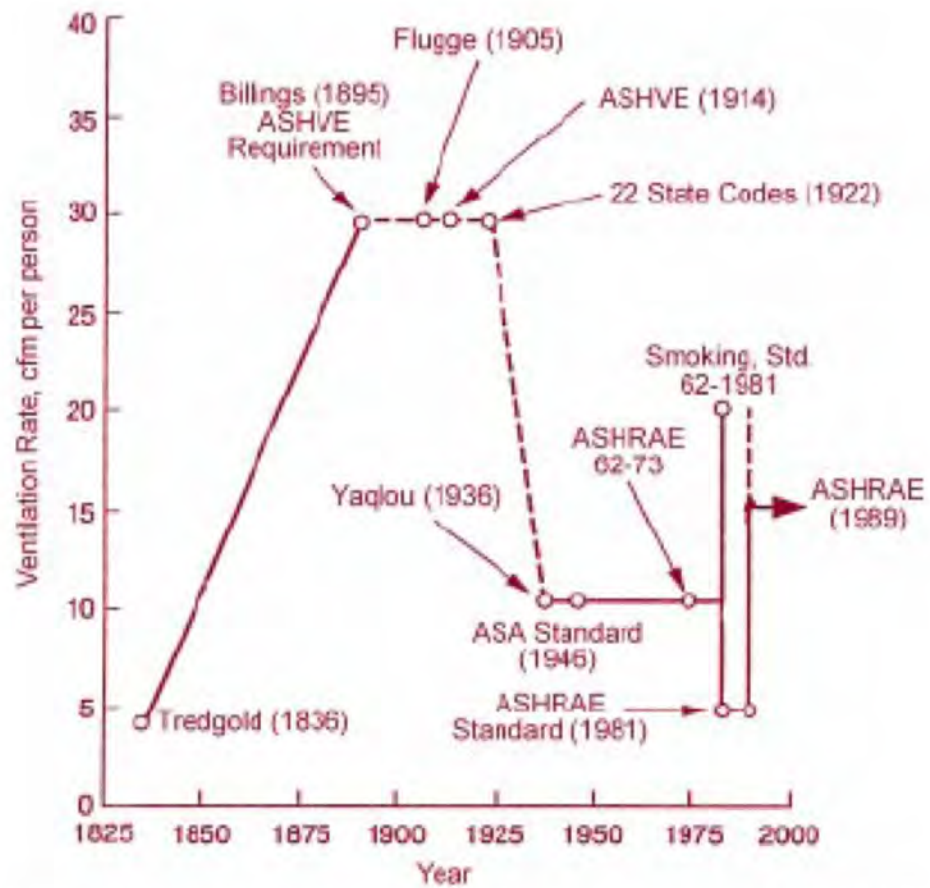

Figure 1: Minimum ventilating rate history.

- 2,000 ft² House, 3 Bedrooms, 8 ft Ceiling, Volume 16,000 ft³

- | | | | |
|-----------|--------|--------------------|--------|
| • .35 ach | 93 cfm | 62-73 10cfm/person | 40 cfm |
| • .30 ach | 80 cfm | 62-89 15cfm/person | 60 cfm |
| • .25 ach | 67 cfm | .35 ach | 90 cfm |
| • .20 ach | 53 cfm | 62.2-2010 | 50 cfm |
| • .15 ach | 40 cfm | 62.2-2013 | 90 cfm |
| • | | 20cfm/person | 80 cfm |

- ASHRAE 62.2 – 2015
- (7.5 cfm/person + 0.03 cfm/ft²)

- 2018 IRC
- (7.5 cfm/person + 0.01 cfm/ft²)

- Occupancy is deemed to be the number of bedrooms plus one

- Outcome for 62.2– 2015 is often bad
- Part load humidity problems in the summer
- Dryness problems in the winter
- Energy problems all the time

- Outcome for 62.2– 2015 is often bad
- Part load humidity problems in the summer
- Dryness problems in the winter
- Energy problems all the time
- Minnesota's Code is half of 62.2 -2015
- Canada's Code is less than half

- Requires Dehumidifiers in the Southeast
- Requires Humidifiers in the North

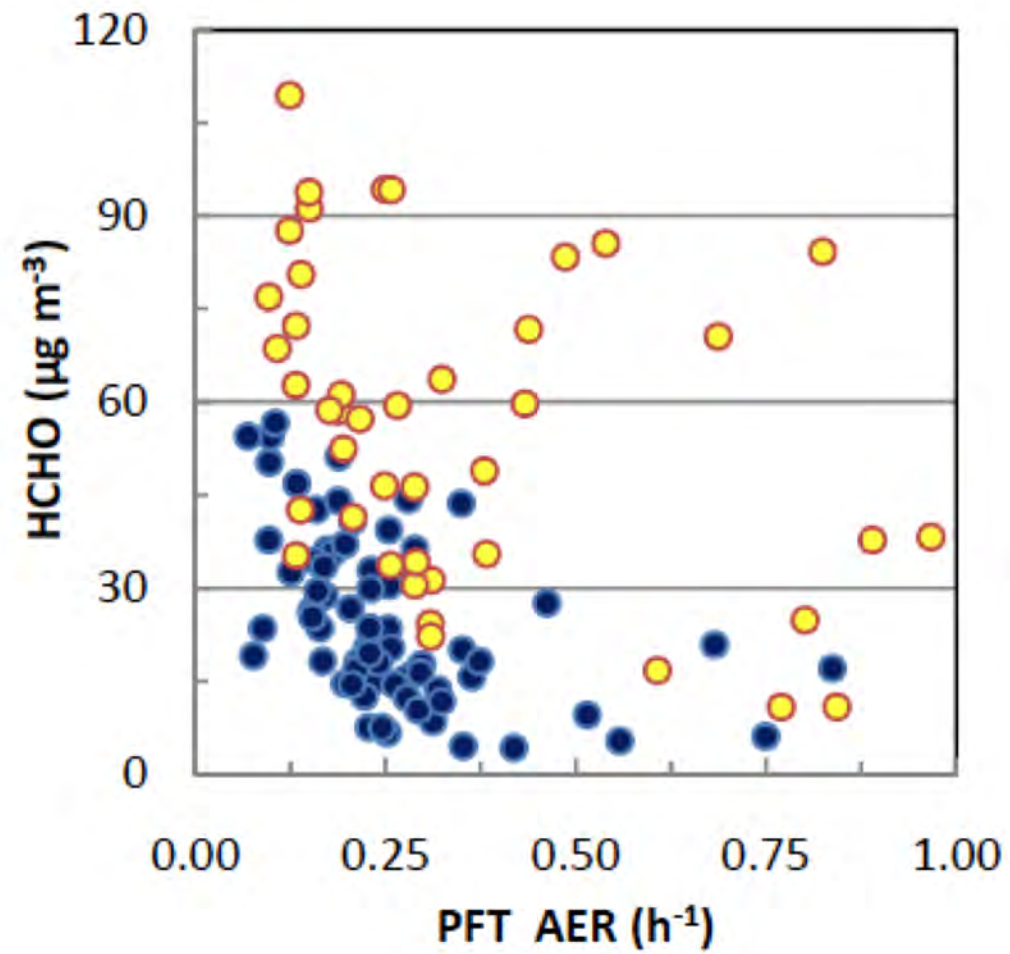

**Formaldehyde sample concentration versus
PFT measured outside air exchange rate over the test day**

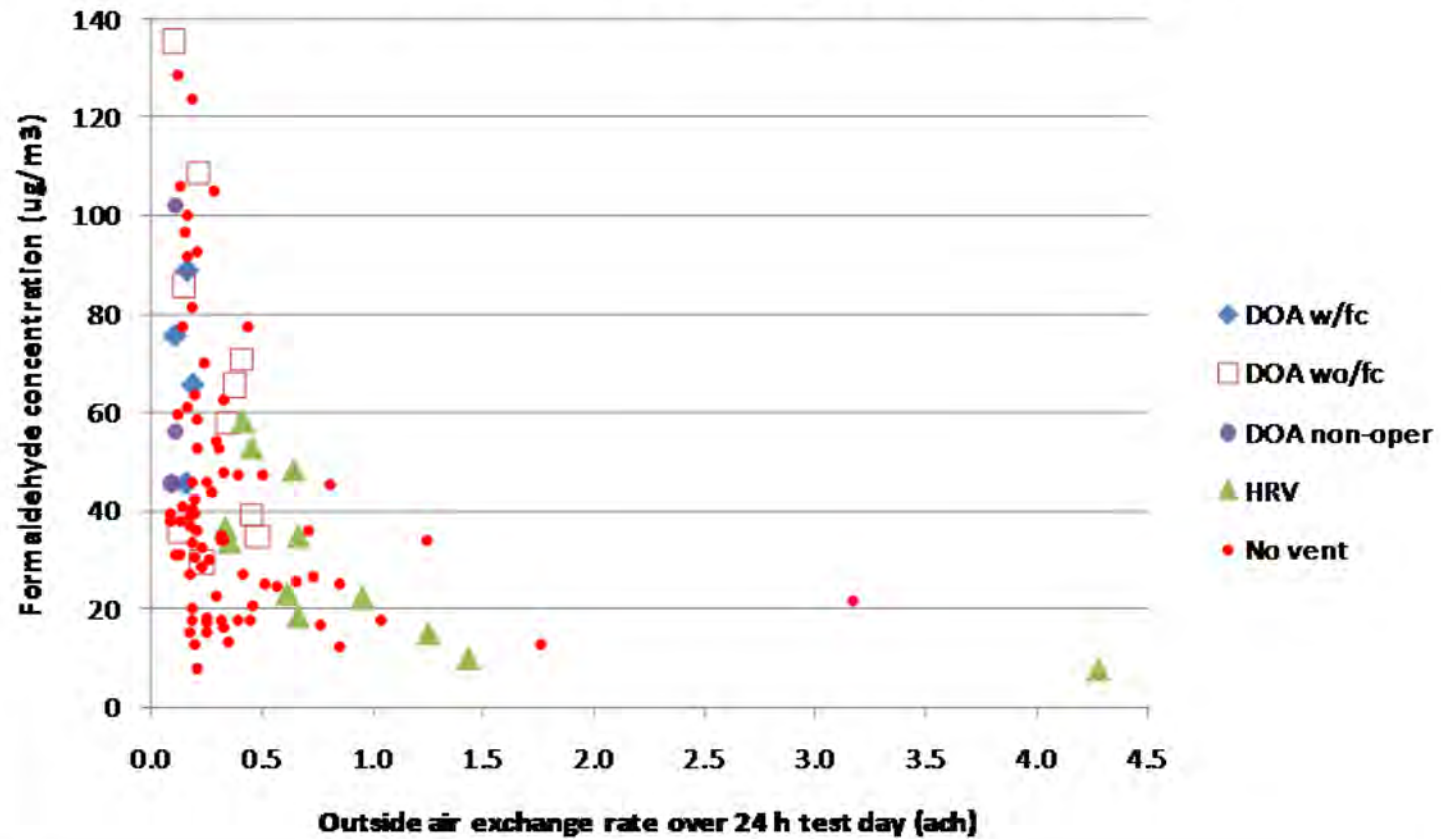

- Dilution Is Not The Solution To Indoor Pollution

Appropriate Strategy

- Ventilate For People Not For The Building

Appropriate Strategy

- Dilution For People
- Source Control For The Building

Balanced Ventilation, Distribution and Mixing

Example Results of Tracer Gas Testing

Laundry Exhaust, 100% of 62.2 Rate, Doors Closed, Transfer Grills Open, No Mixing

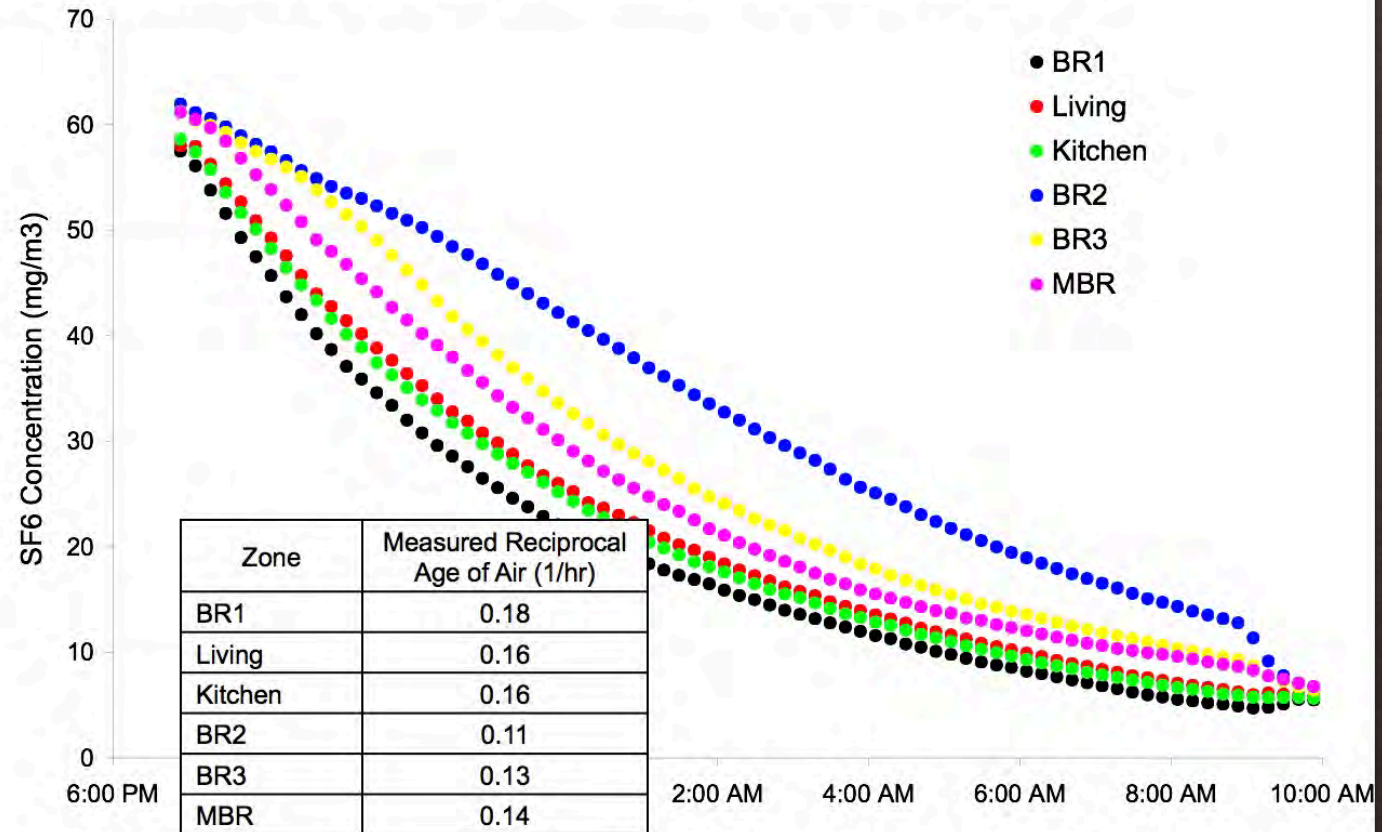

Total Pollutant Concentration by Room

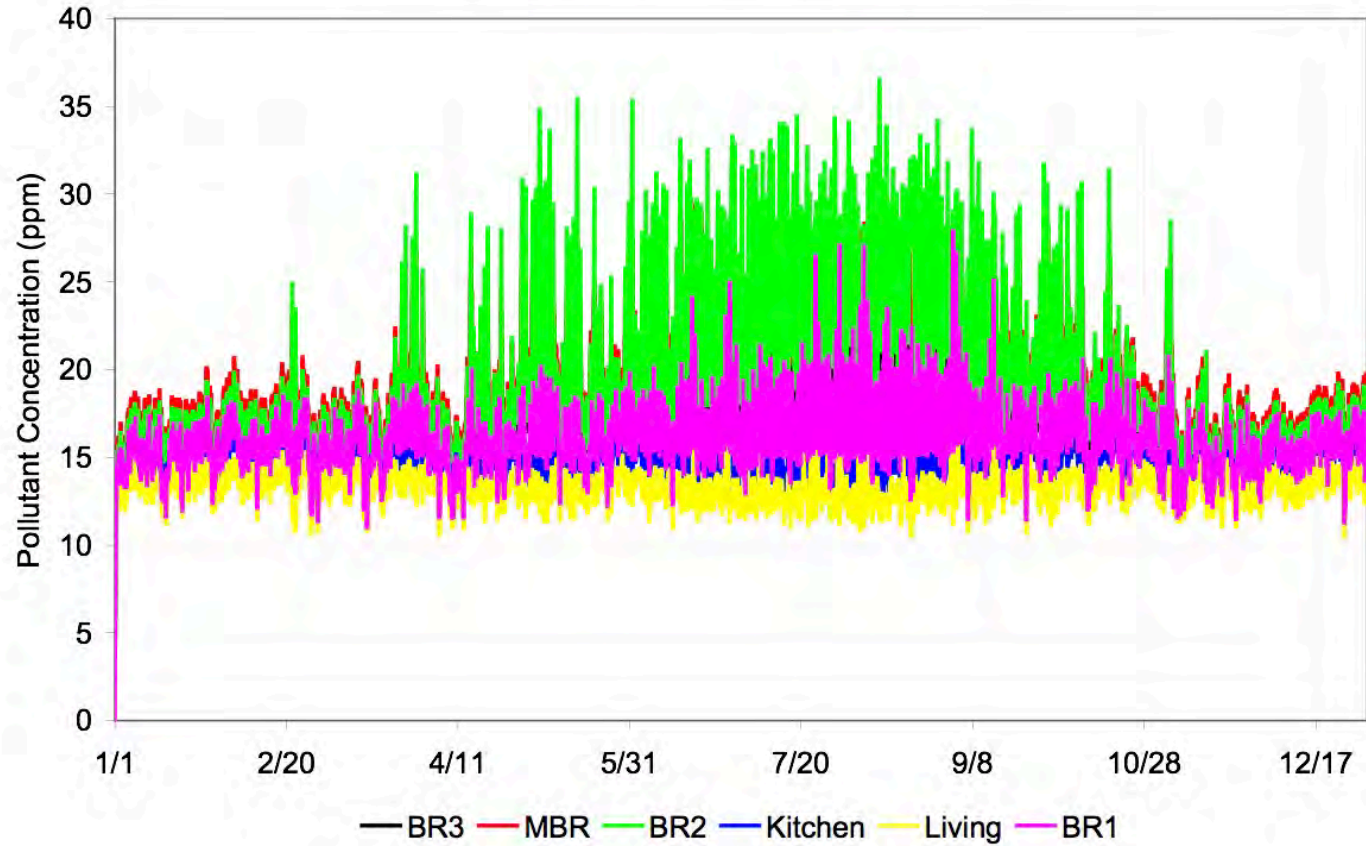

- The Effective Ventilation Rate Can Be Reduced By Half With Balanced Ventilation, Distribution And Mixing When Compared To The Effective Ventilation Rate With Exhaust Only Ventilation Without Distribution And Mixing

- Recommended Range For Relative Humidity
- Above 25 Percent During Winter
- Below 70 Percent During Summer

Ventilation Systems

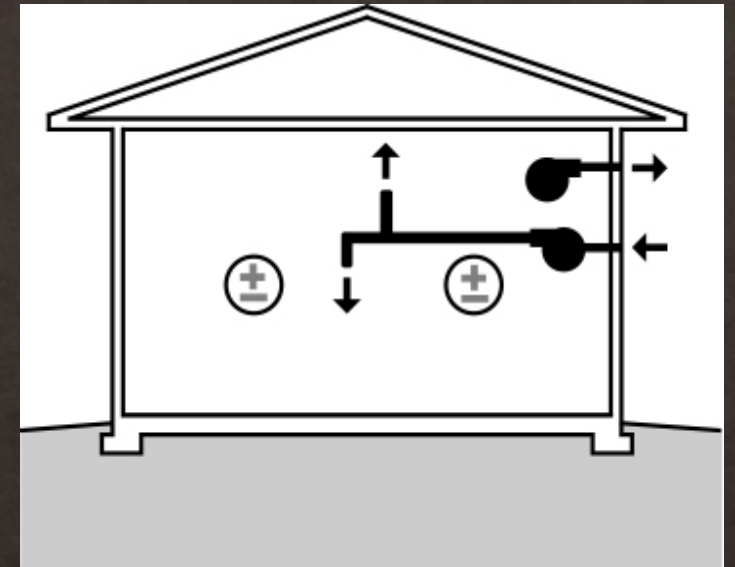
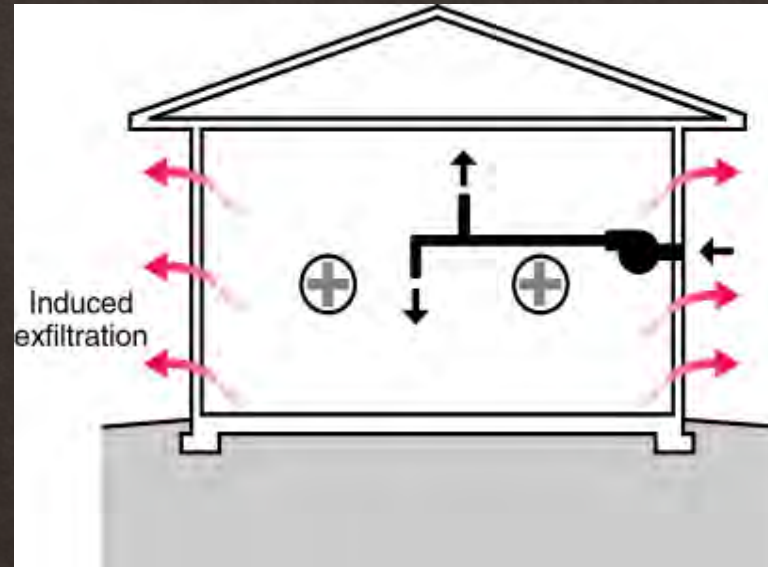
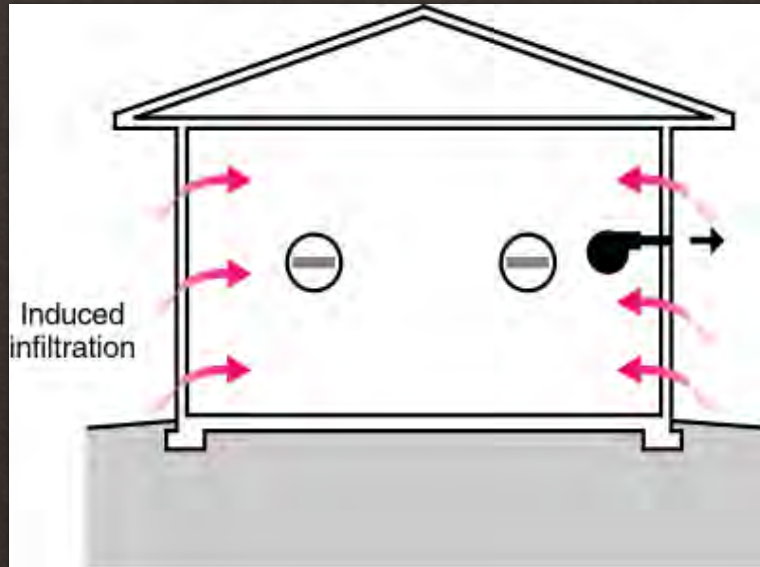

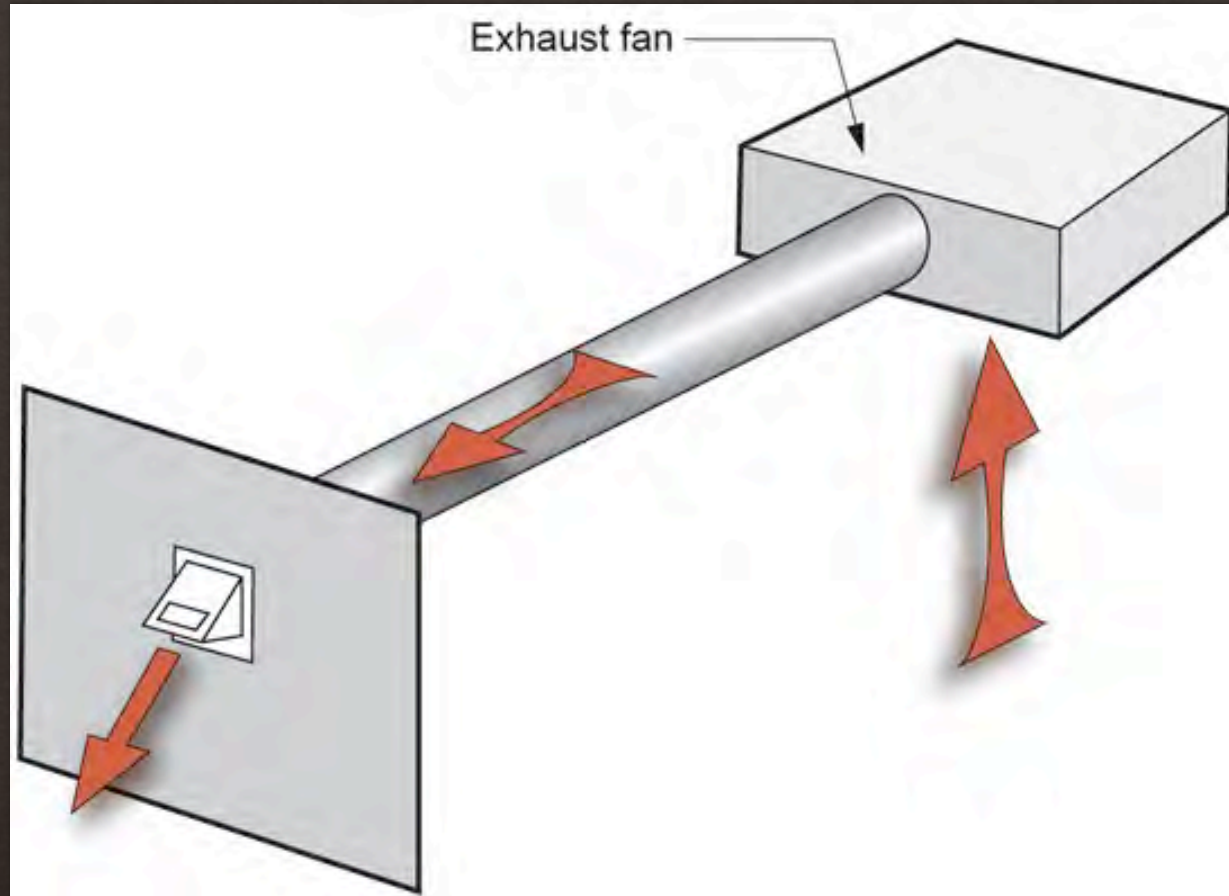

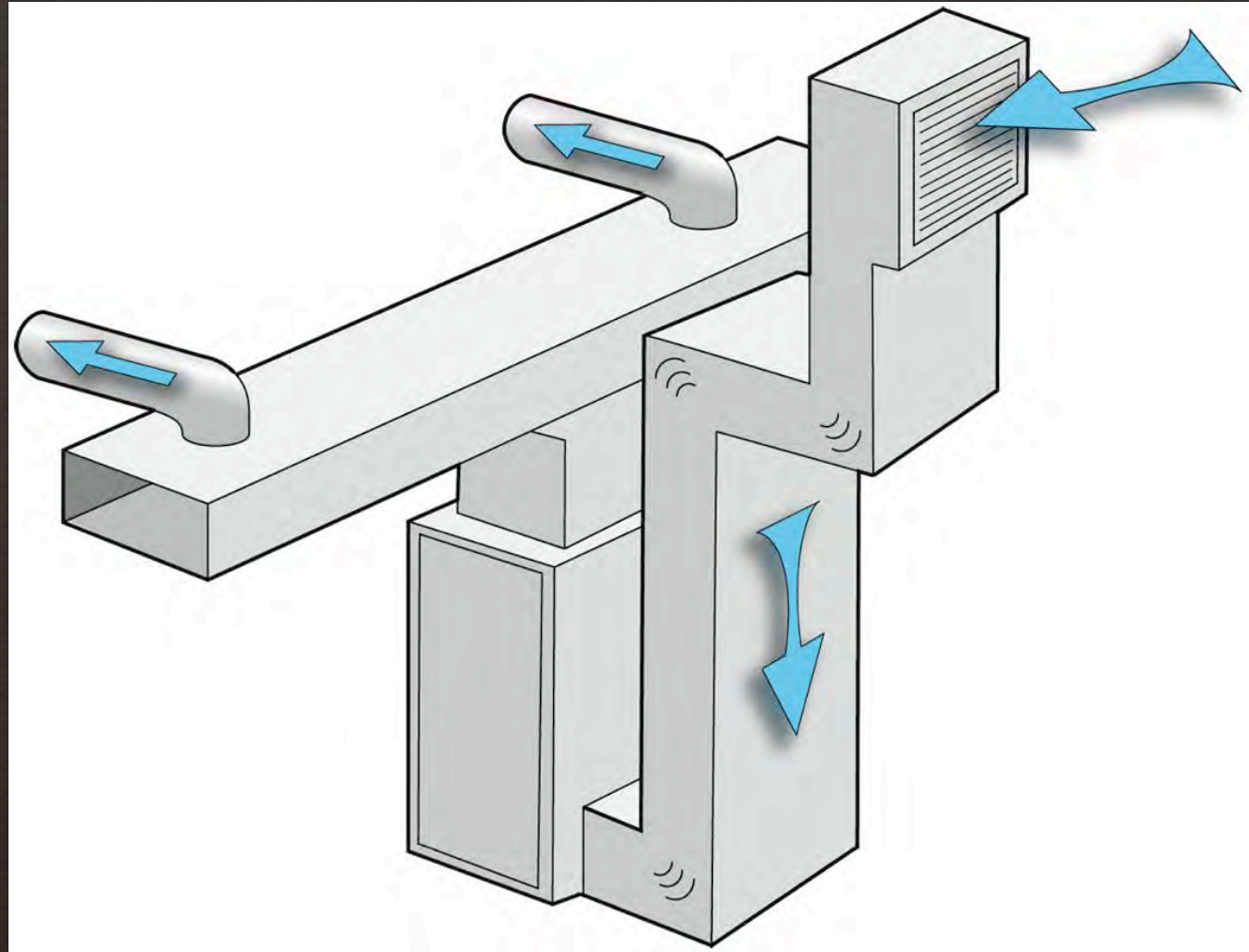

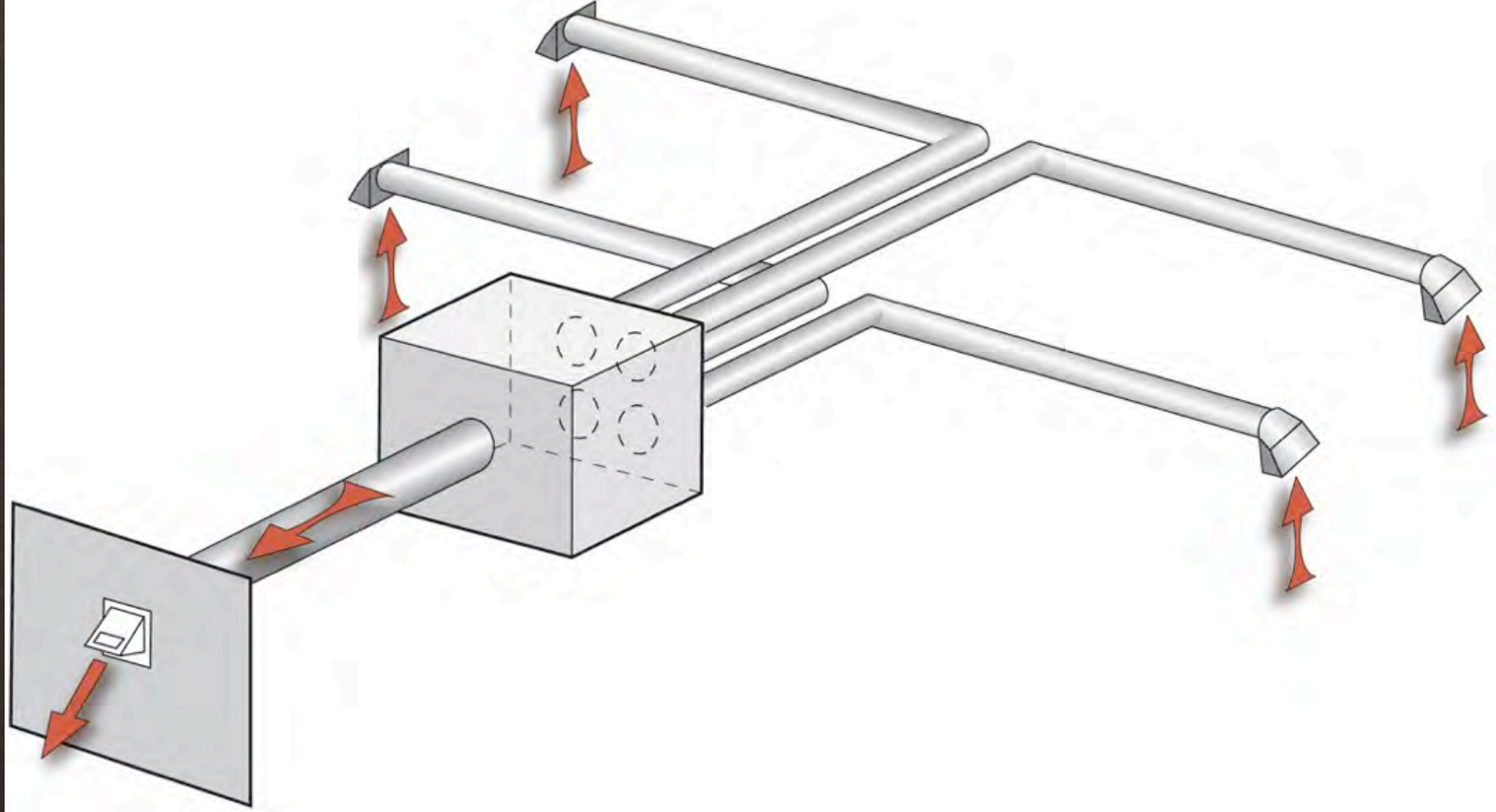

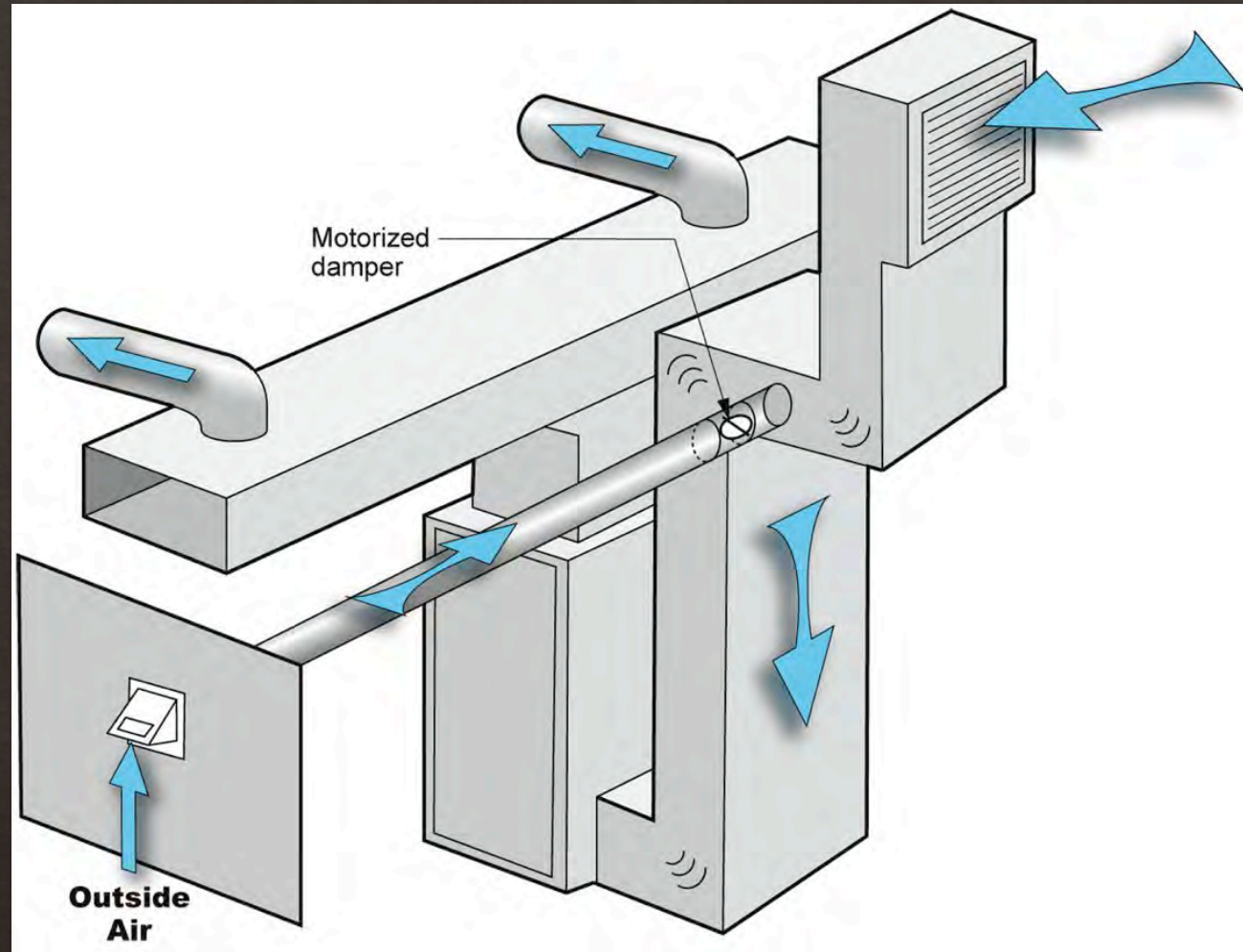

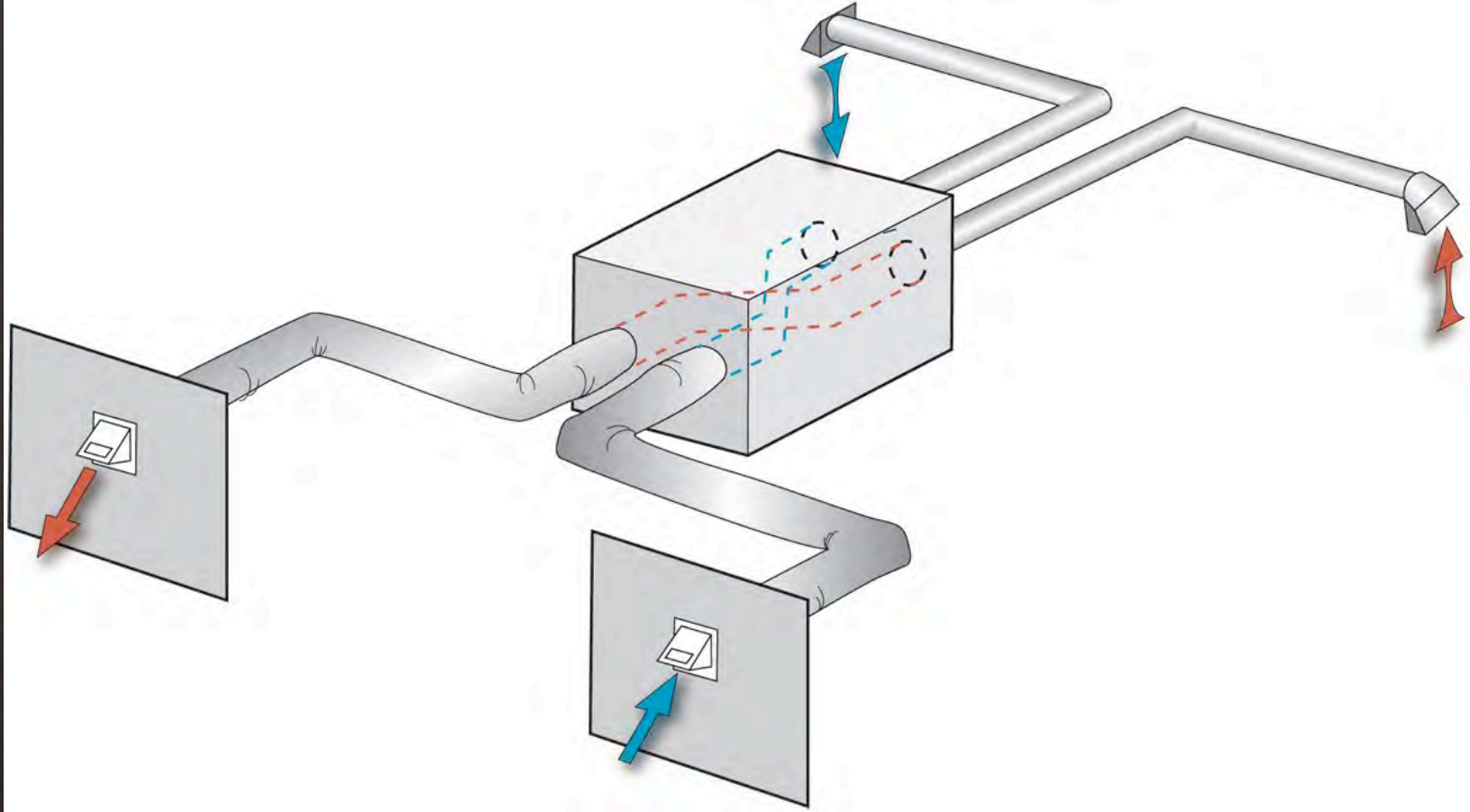

Mechanical Systems

Mechanical Systems

- Cooling System To Make It Cold

Mechanical Systems

- Cooling System To Make It Cold
- Heating System To Make It Warm

Mechanical Systems

- Cooling System To Make It Cold
- Heating System To Make It Warm
- Dehumidification System To Make It Dry

Mechanical Systems

- Cooling System To Make It Cold
- Heating System To Make It Warm
- Dehumidification System To Make It Dry
- Ventilation System To Control Odors

Mechanical Systems

- Cooling System To Make It Cold
- Heating System To Make It Warm
- Dehumidification System To Make It Dry
- Ventilation System To Control Odors
- Distribution System To Make It Uniform

Mechanical Systems

- Cooling System To Make It Cold
- Heating System To Make It Warm
- Dehumidification System To Make It Dry
- Ventilation System To Control Odors
- Distribution System To Make It Uniform
- Range Hoods Are A Special Kind of Hell

Mechanical Systems

- Don't Try To Combine Them

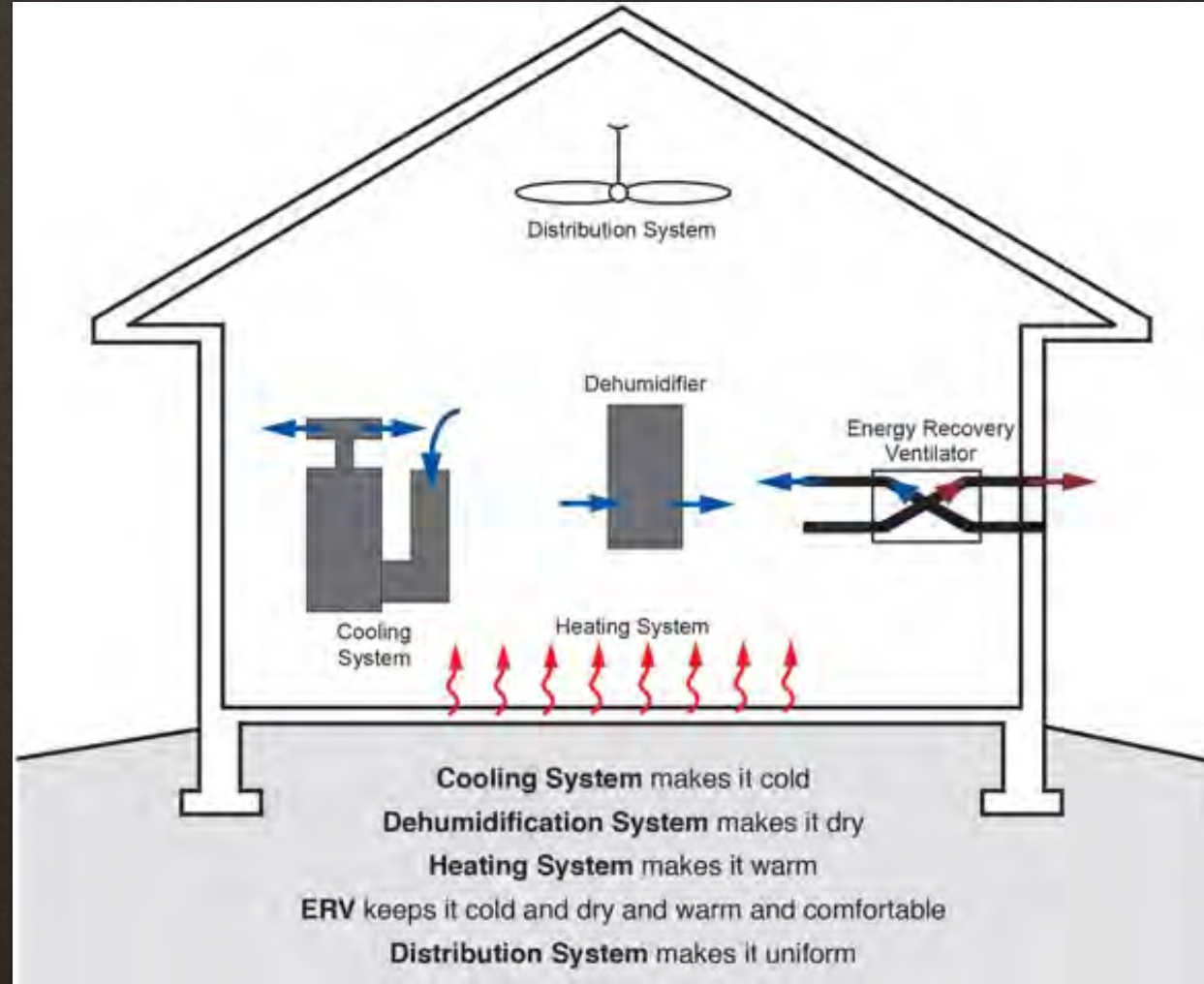

Kitchen Exhaust Hoods

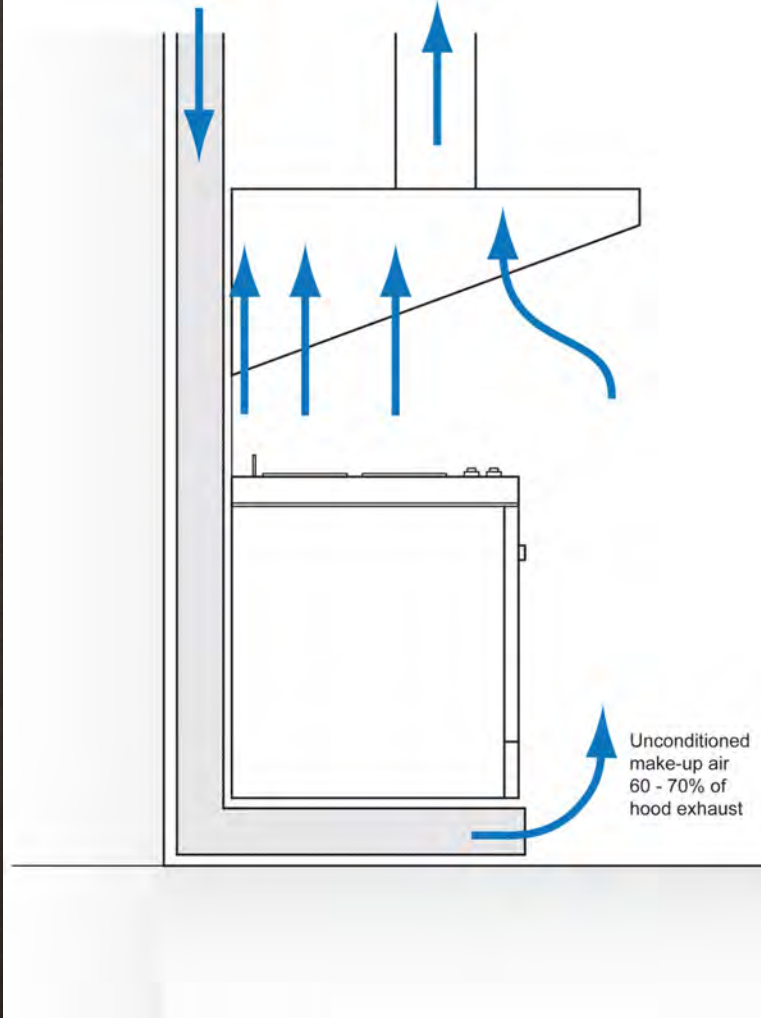



IAQ & Energy 2018

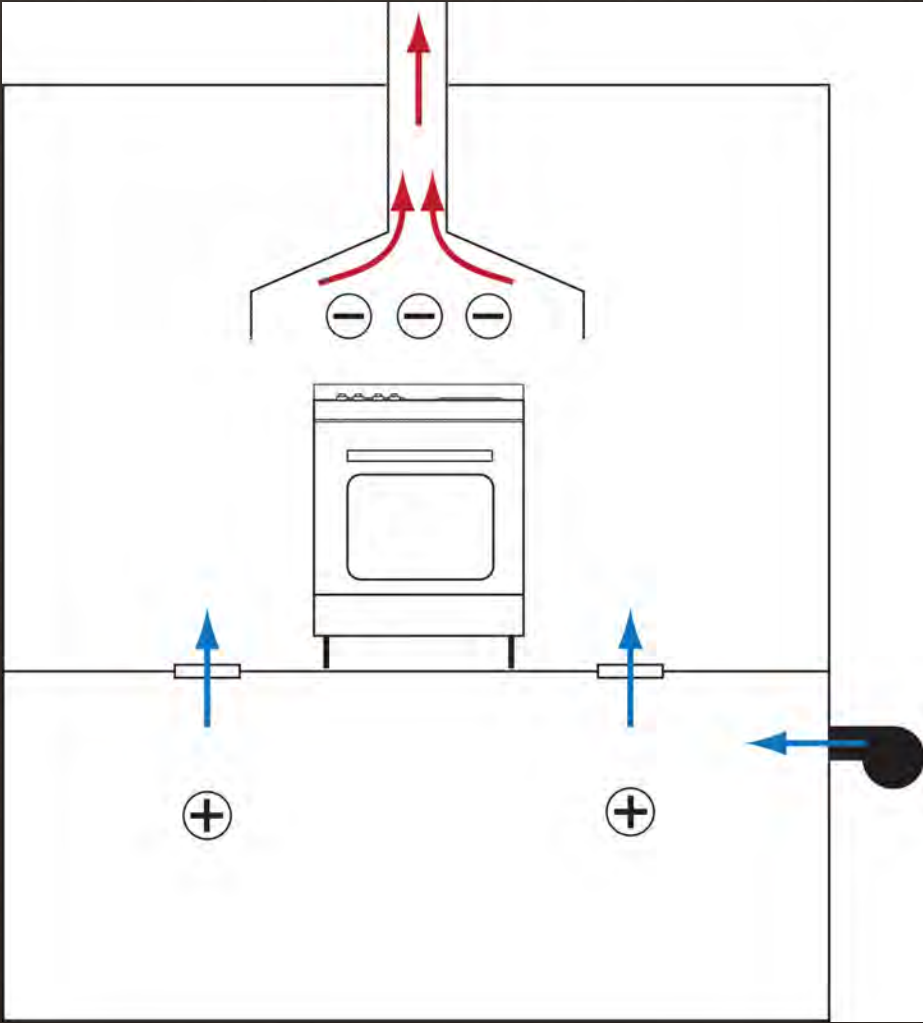

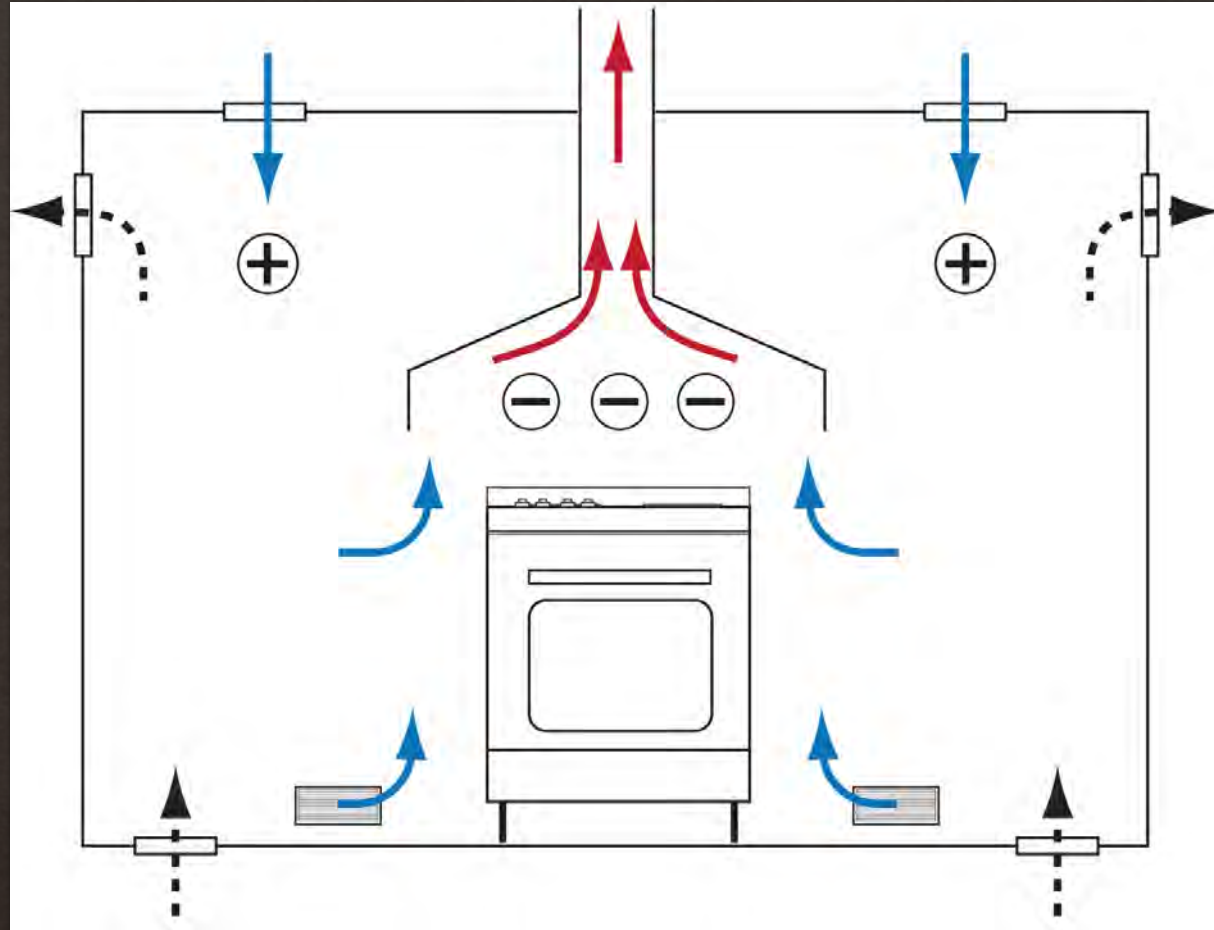



IAQ & Energy 2018





IAQ & Energy 2018



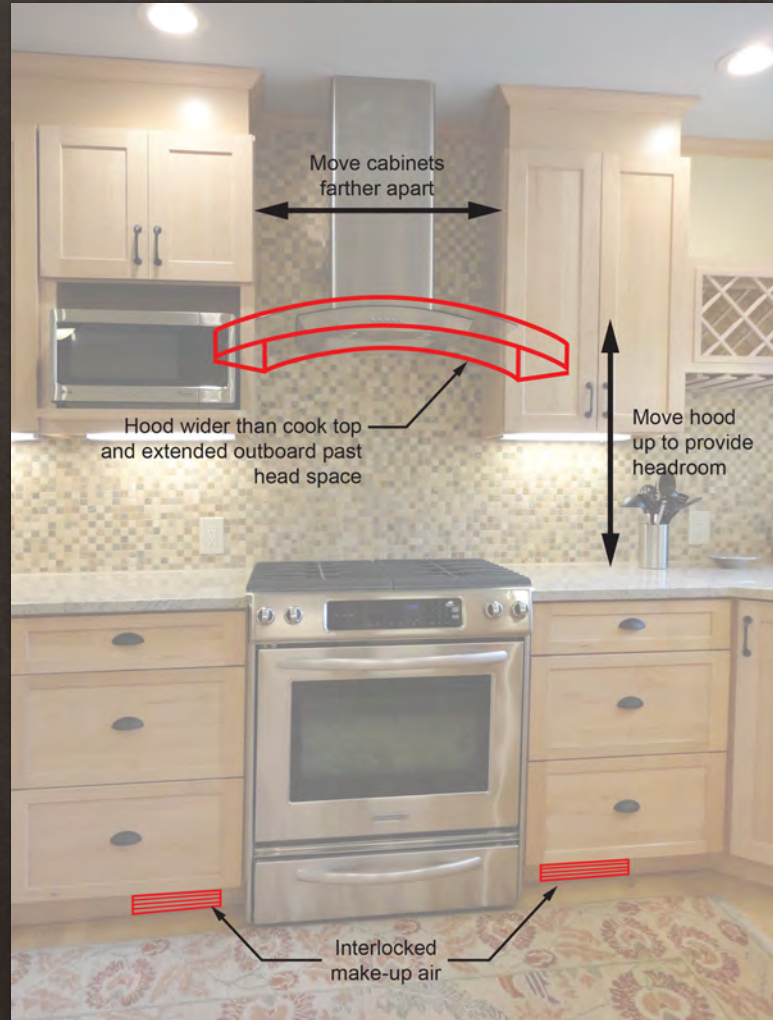

Fireplaces









IAQ & Energy 2018

Dryers



IAQ & Energy 2018



IAQ & Energy 2018

Multifamily

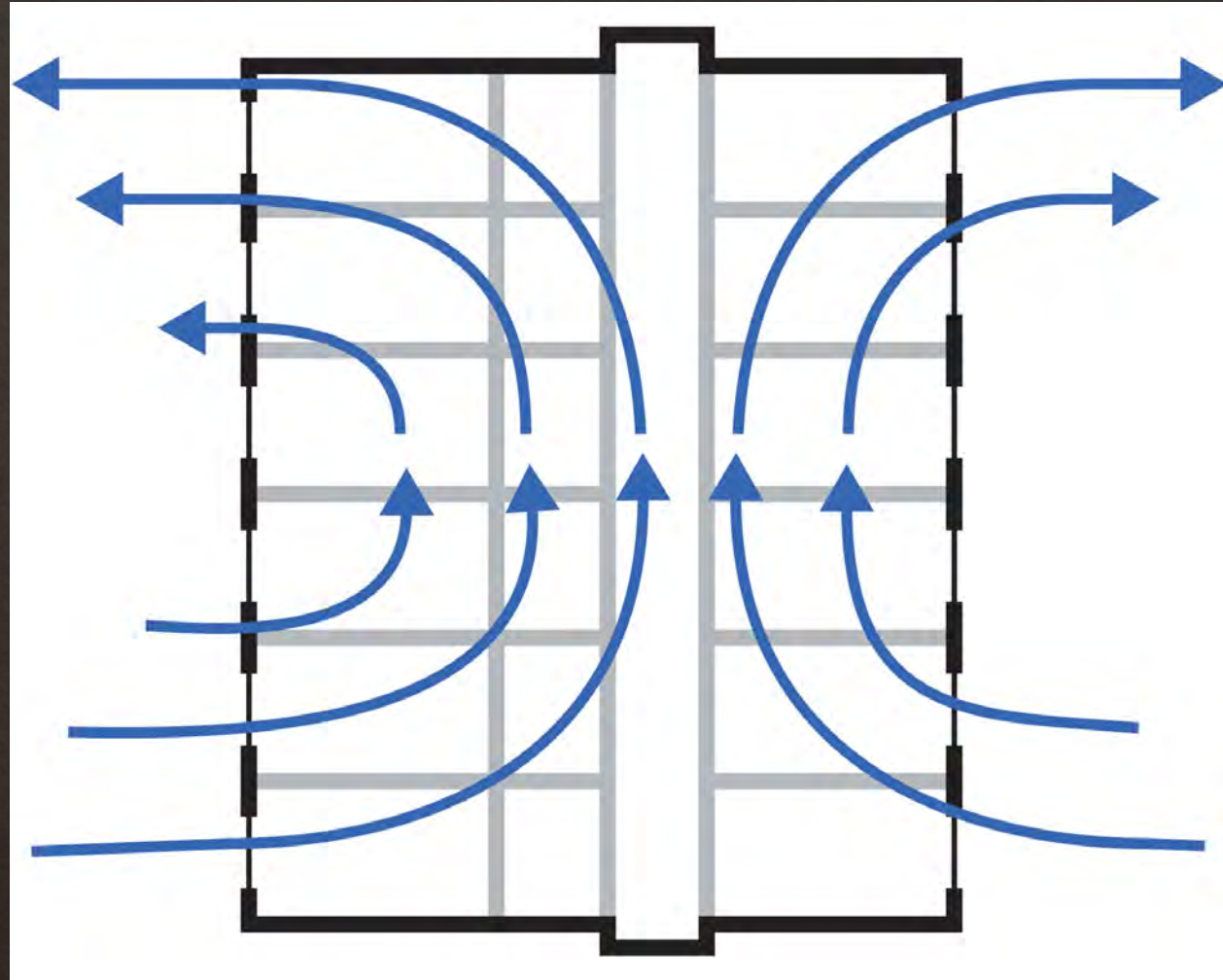

Reduced Individual
Unit Stack Effect

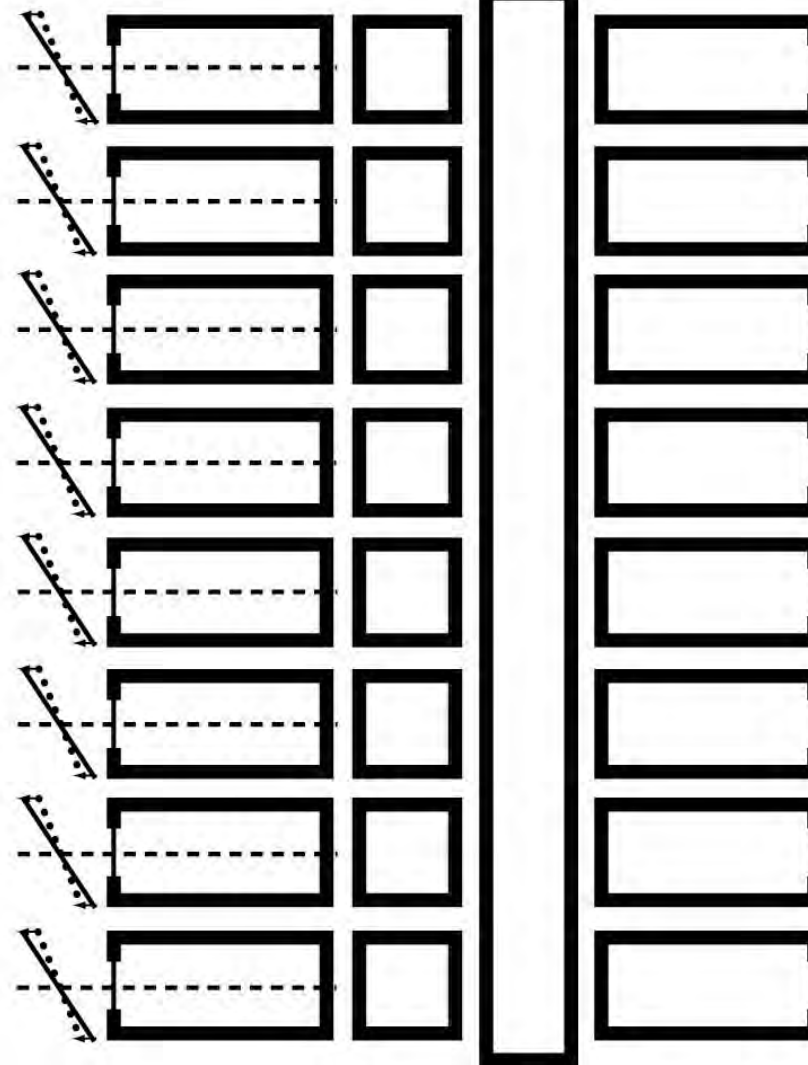

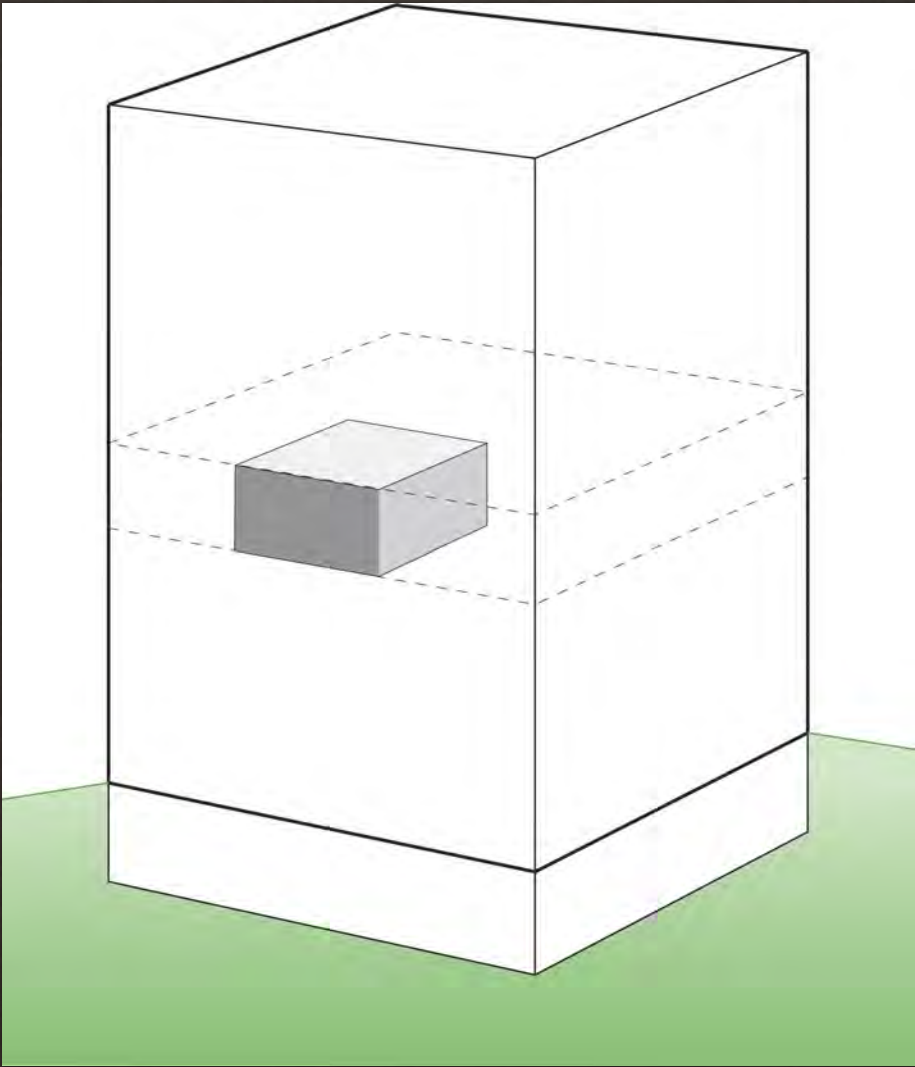

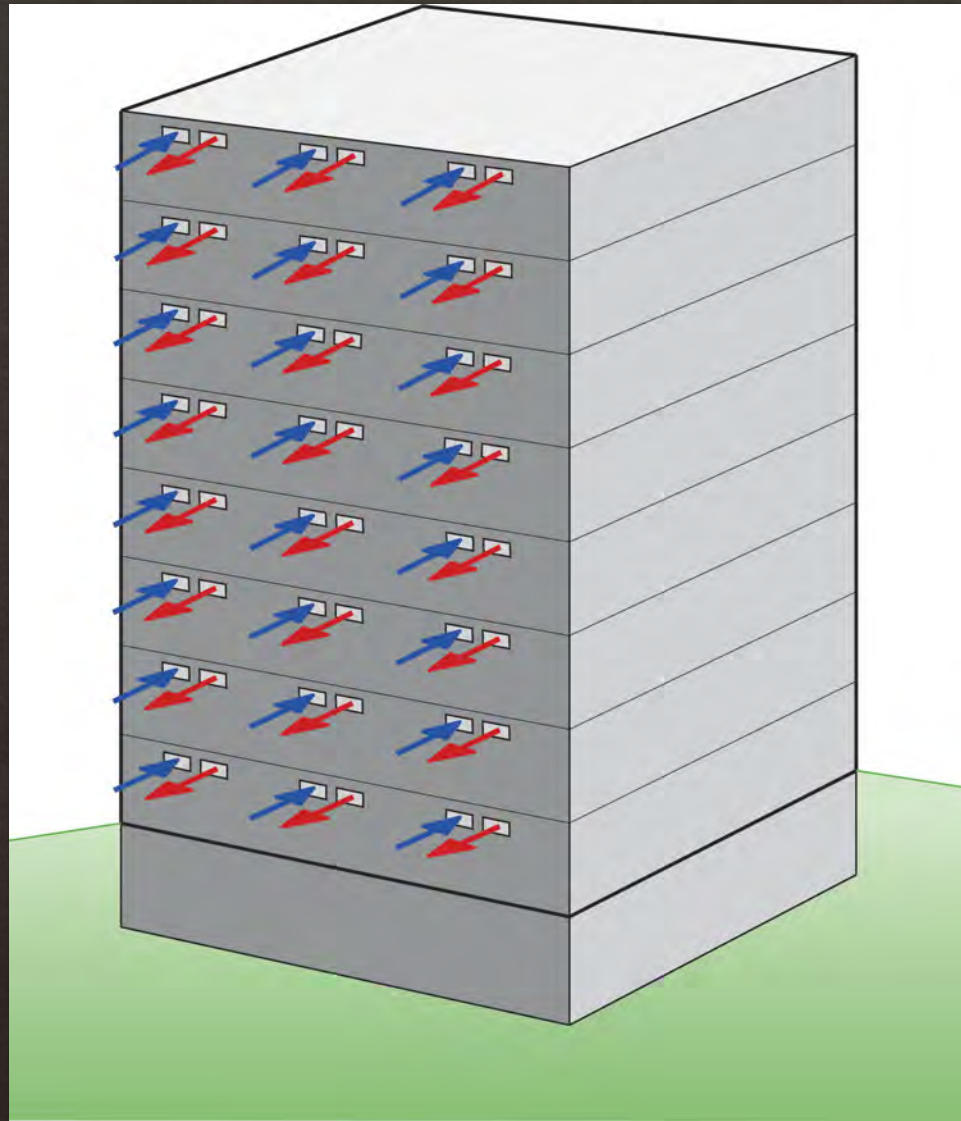



IAQ & Energy 2018

Don't Do Stupid Things

- Combustion Safety
- Sealed Combustion Appliances

Don't Do Stupid Things

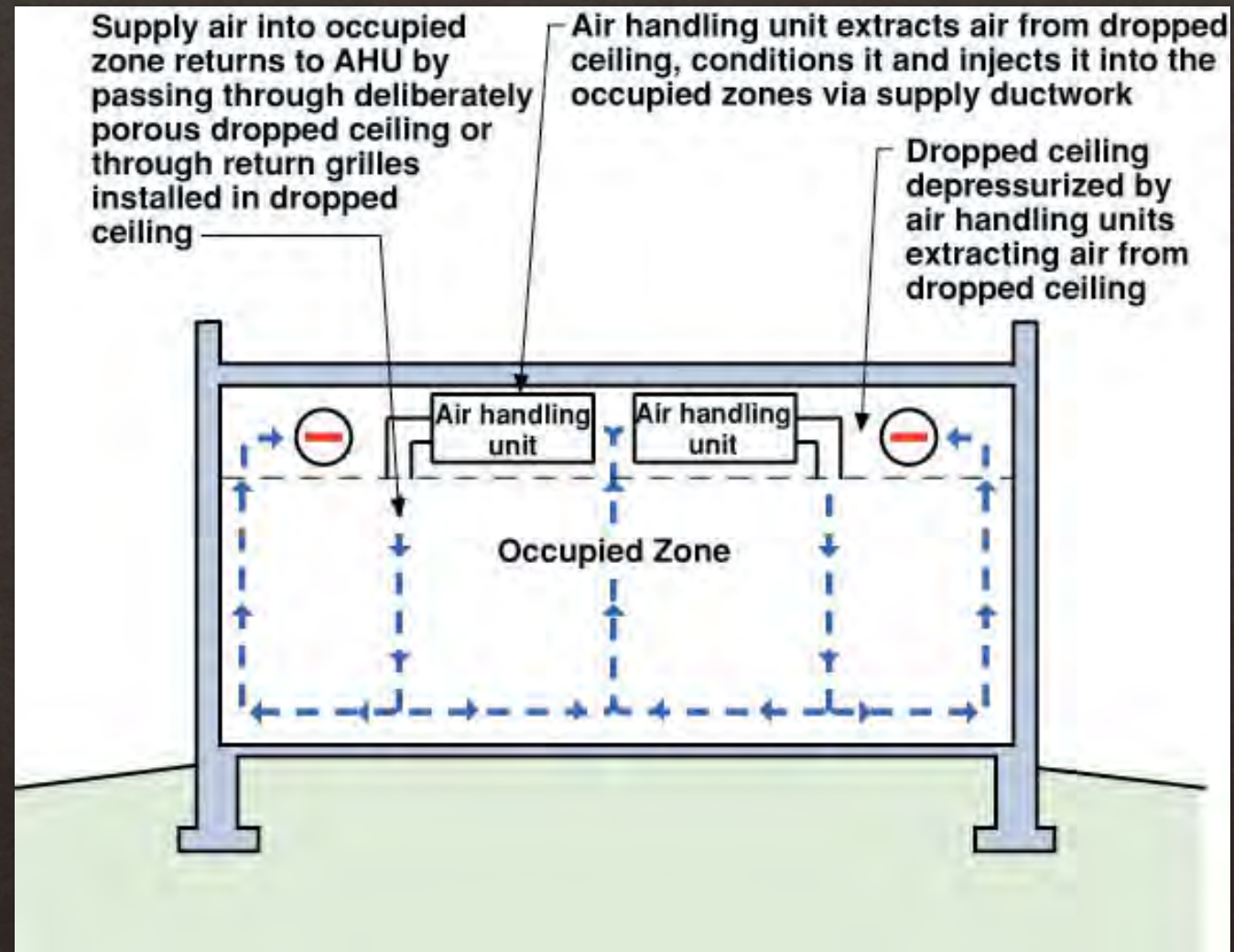

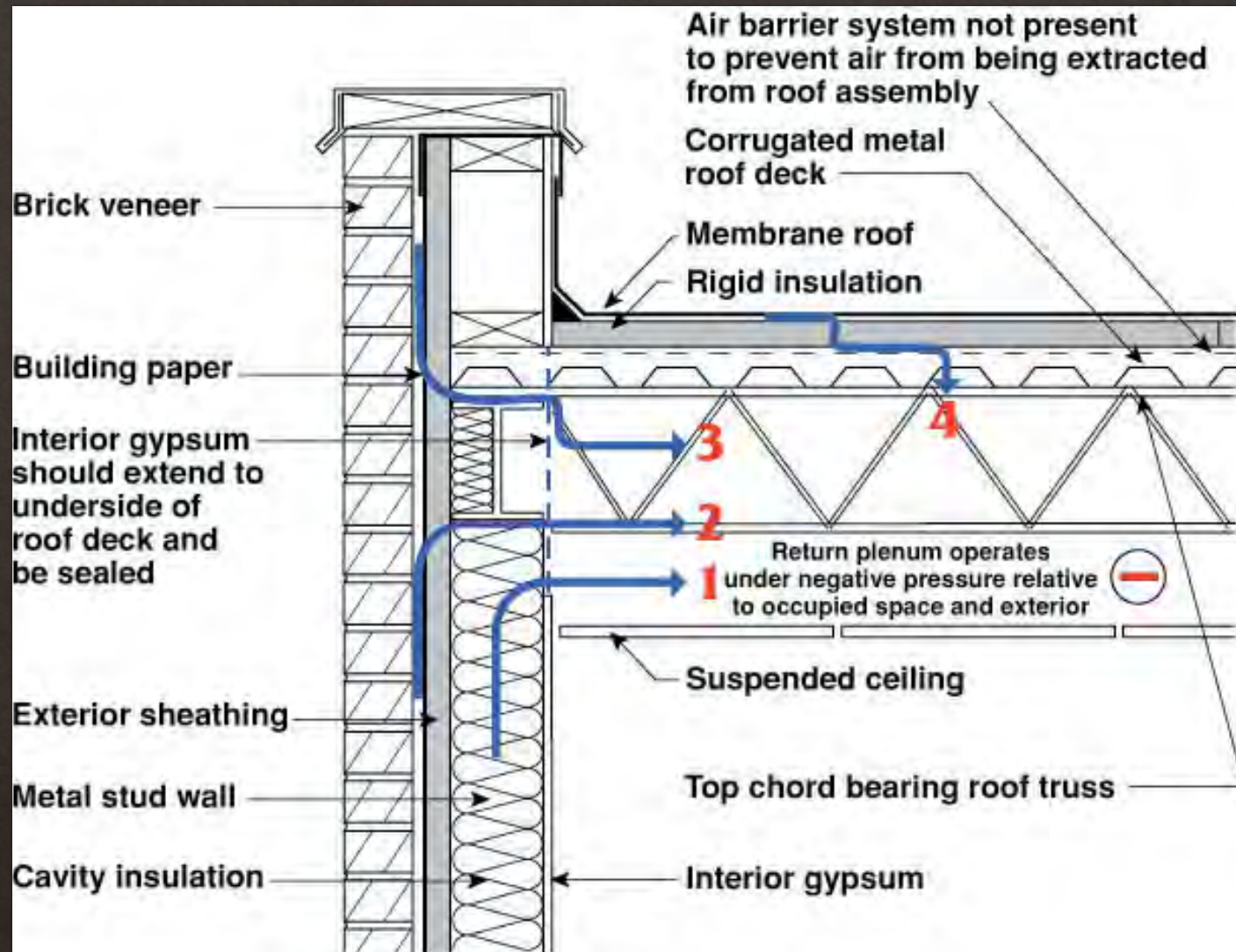

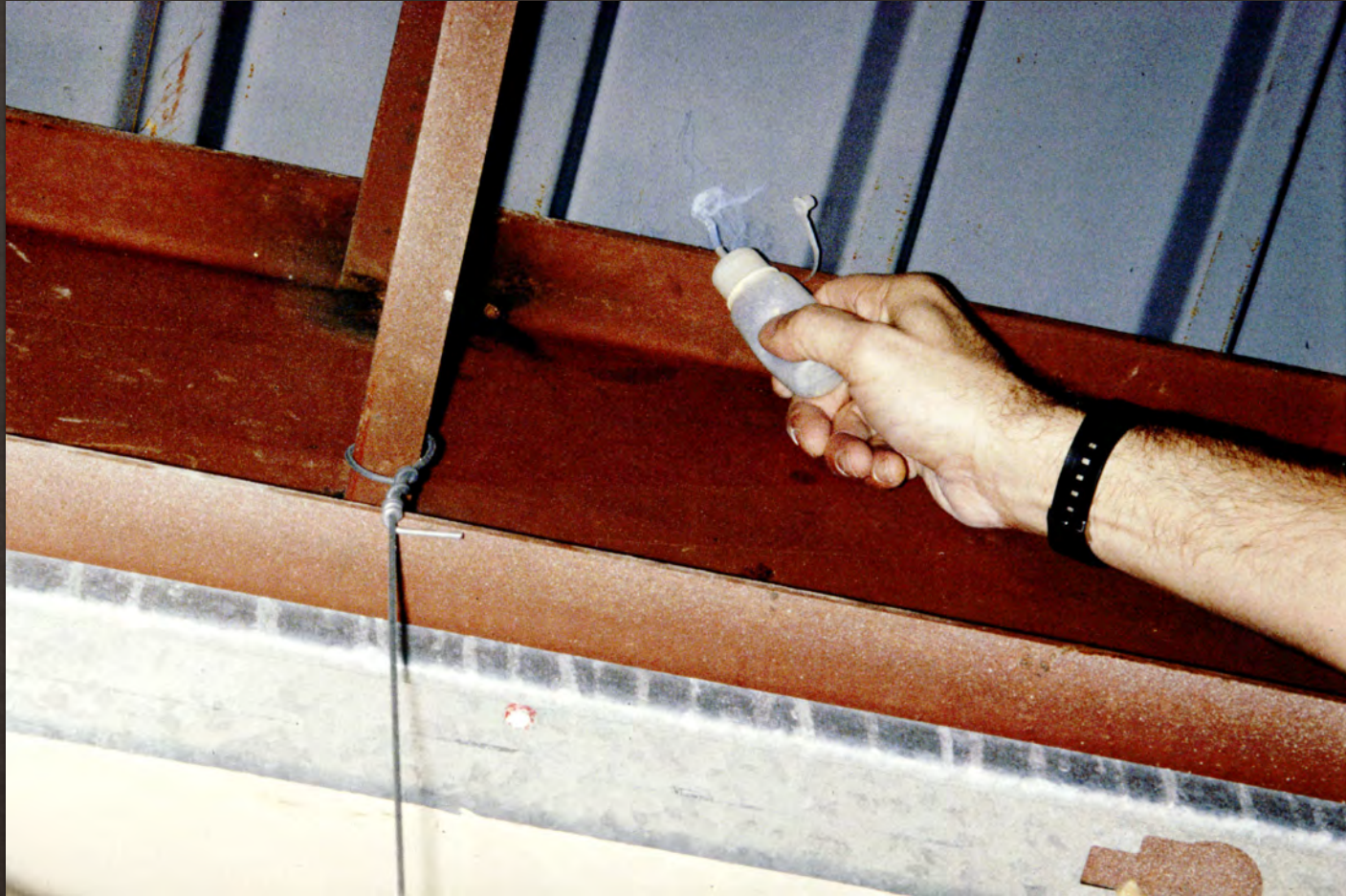



IAQ & Energy 2018



IAQ & Energy 2018





IAQ & Energy 2018



IAQ & Energy 2018



IAQ & Energy 2018

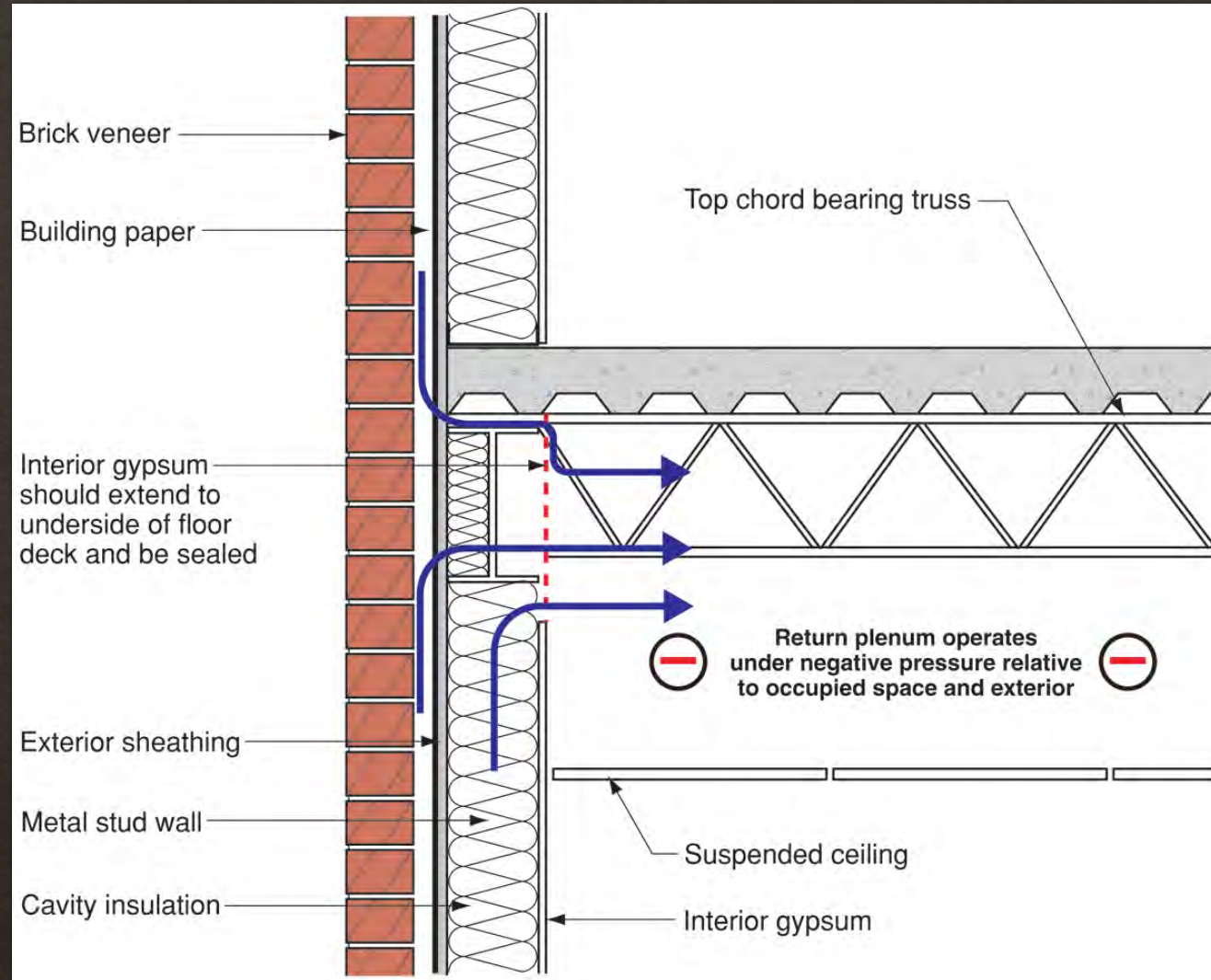



IAQ & Energy 2018





IAQ & Energy 2018



IAQ & Energy 2018

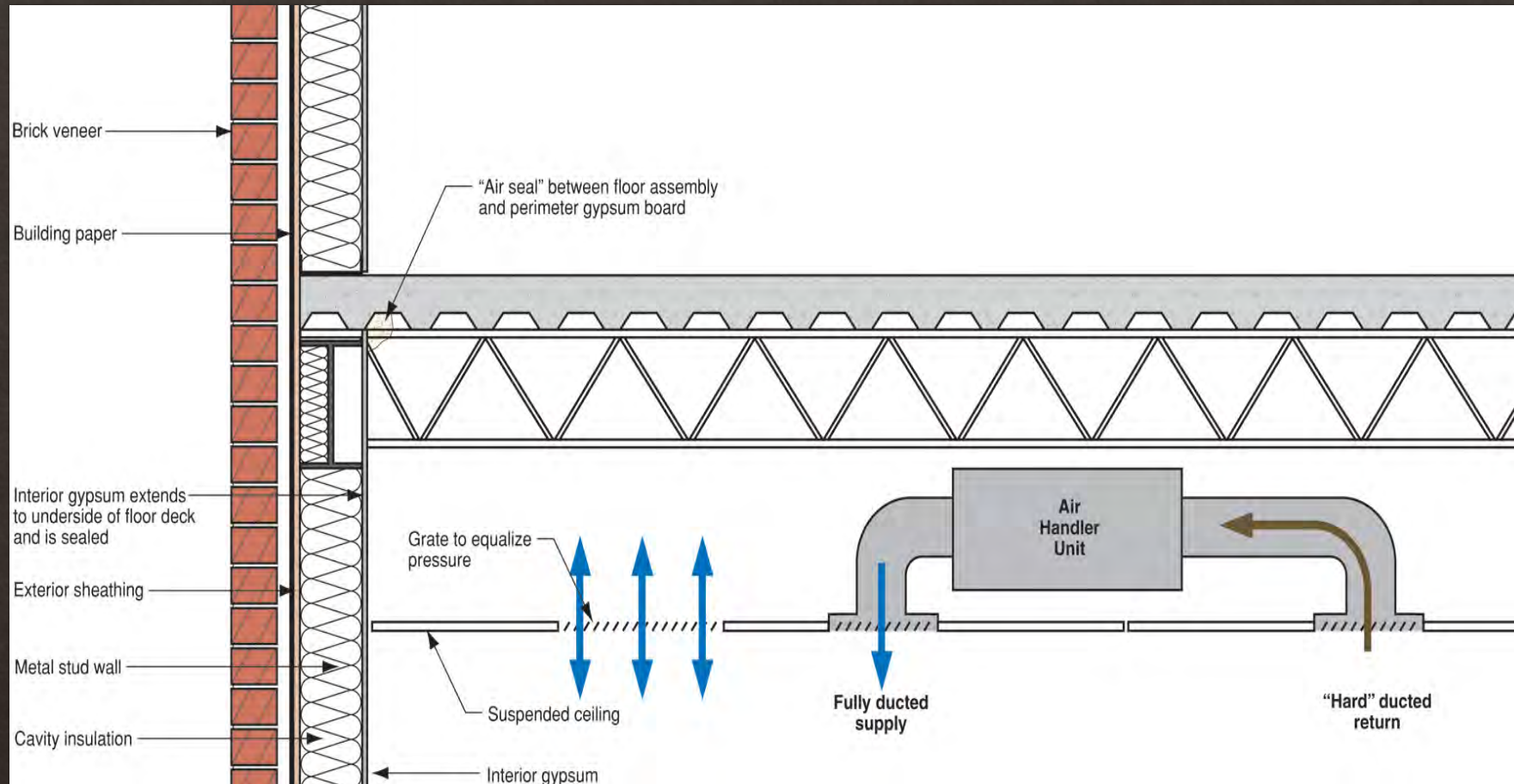



IAQ & Energy 2018

Presenter Contact Information

Joseph Lstiburek

Building Science Corporation

joe@buildingscience.com

www.buildingscience.com

(978) 589 - 5100

Disclaimer

- This presentation is not intended to be a comprehensive program covering all aspects of this topic.
- All are participants are encouraged to read and follow applicable standards, codes and regulations related to this topic.
- The views and opinions following are the presenter's opinions and not necessarily the official position of the Maine IAQ Council, IAQnet LLC, or Healthy Indoors.