

Joseph Lstiburek, Ph.D., P.Eng, ASHRAE Fellow

# Building Science

---

## Adventures In Building Science

[www.buildingscience.com](http://www.buildingscience.com)

# Things Are Different

## Energy Efficiency

### Materials

# There Is No Such Thing As A Free Thermodynamic Lunch

# Condensation on Ductwork

# Condensation on Ductwork

## Ductwork in Vented Attics and Vented Crawlspaces

# Vented and Unvented Attics

## Vented and Unvented Crawlspace

# There Is Nothing Wrong With A Vented Attic

There Is Nothing Wrong With A Vented Attic  
But.....



Houses With Vented Attics Suck  
Not all the Time.....but.....





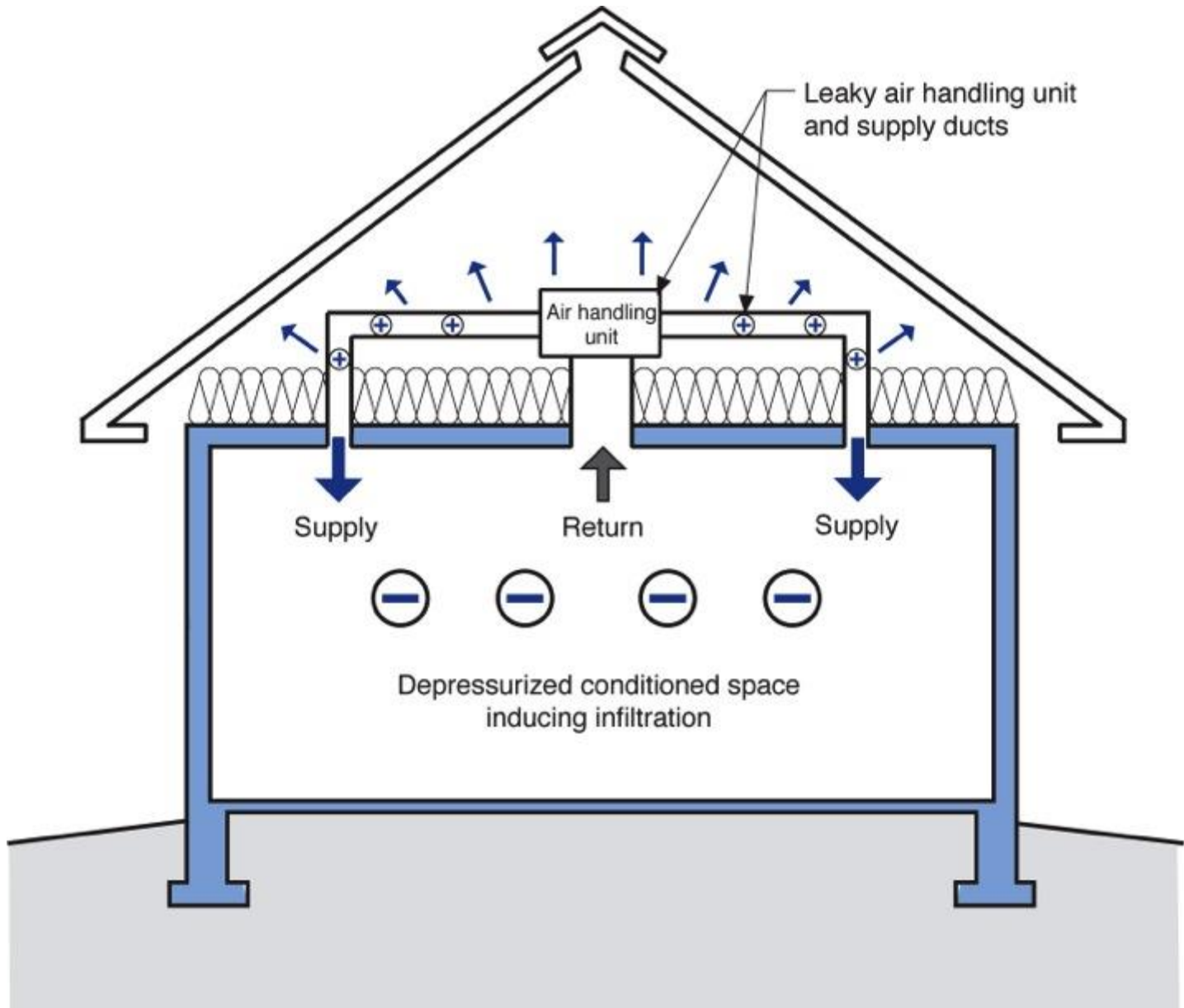

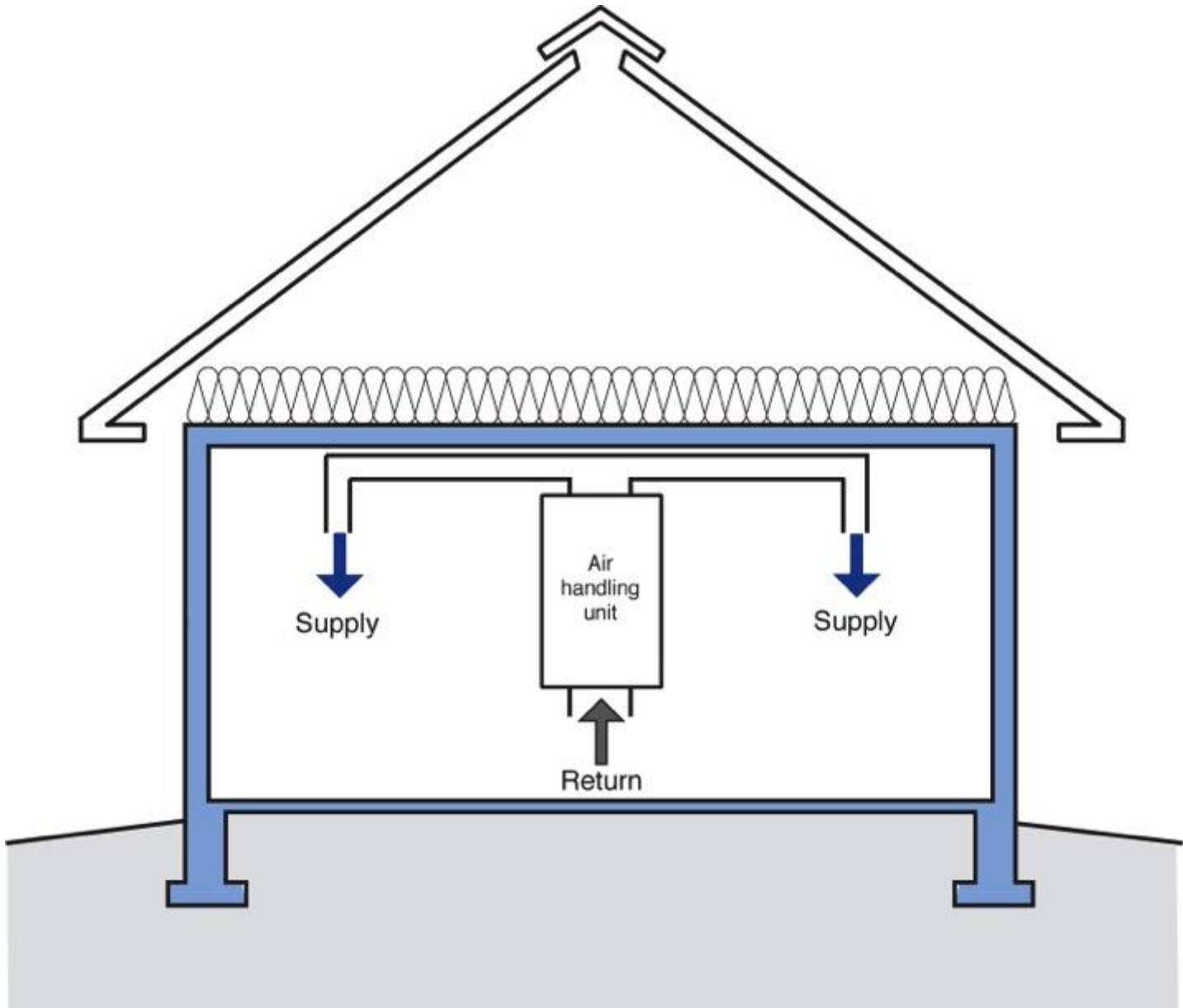

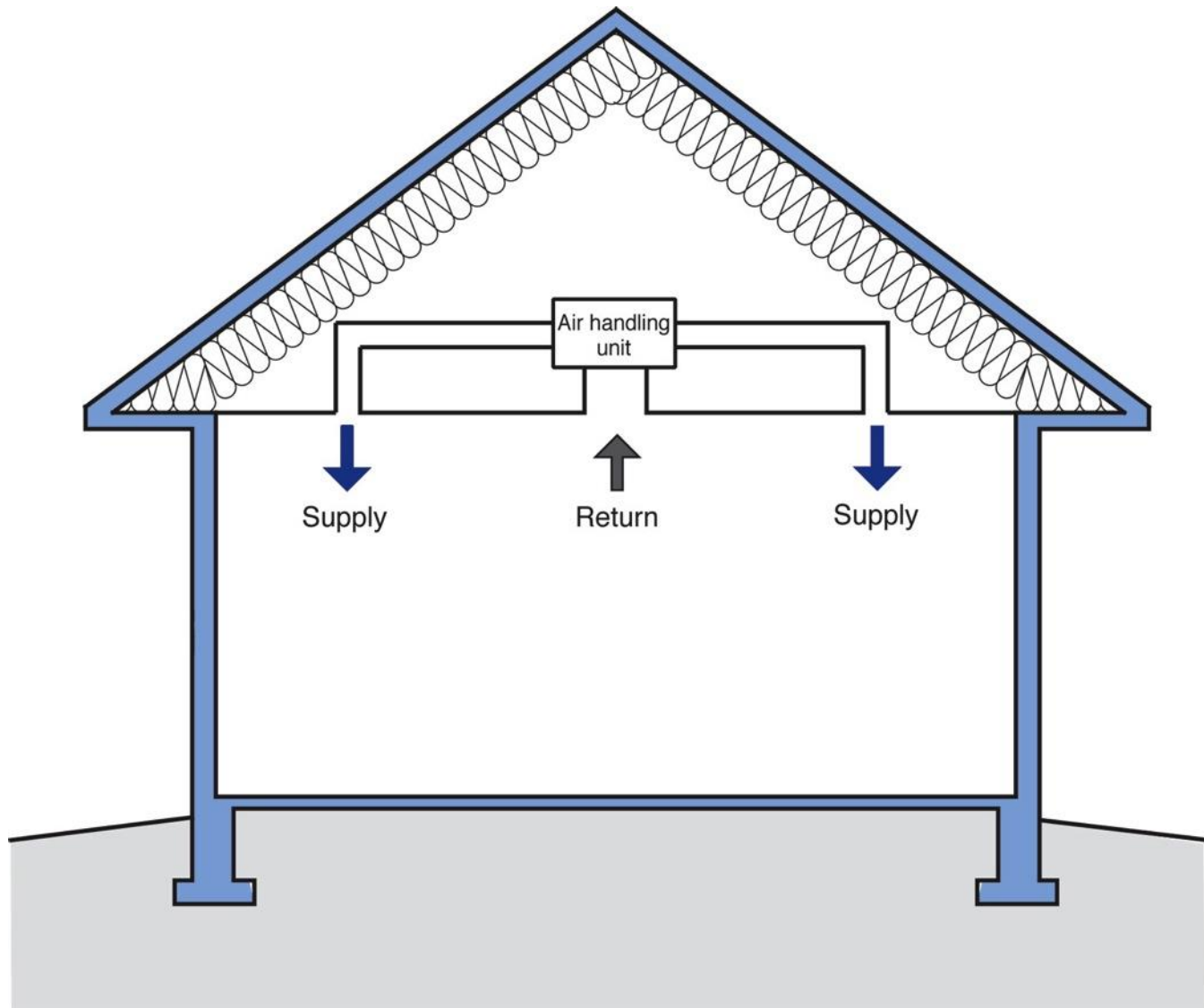

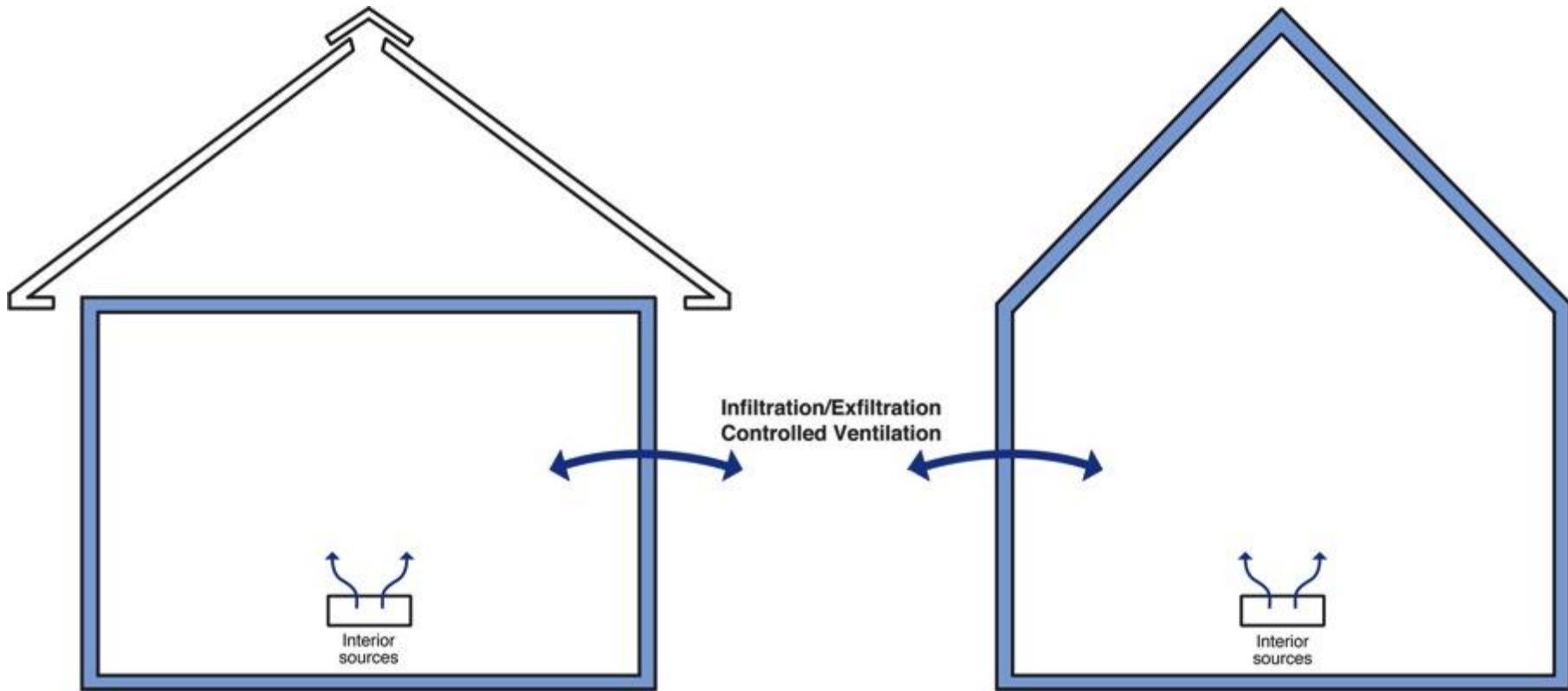









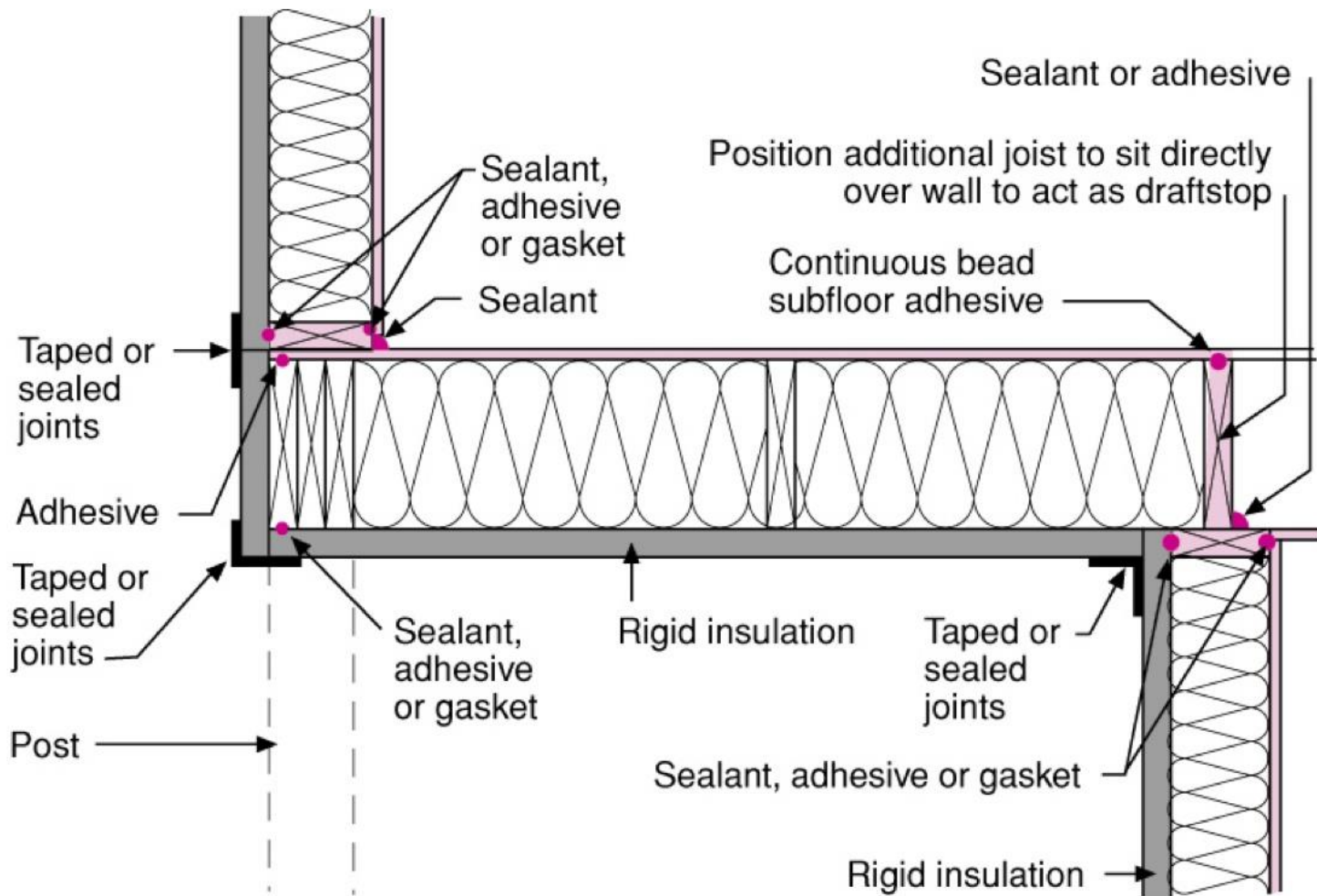

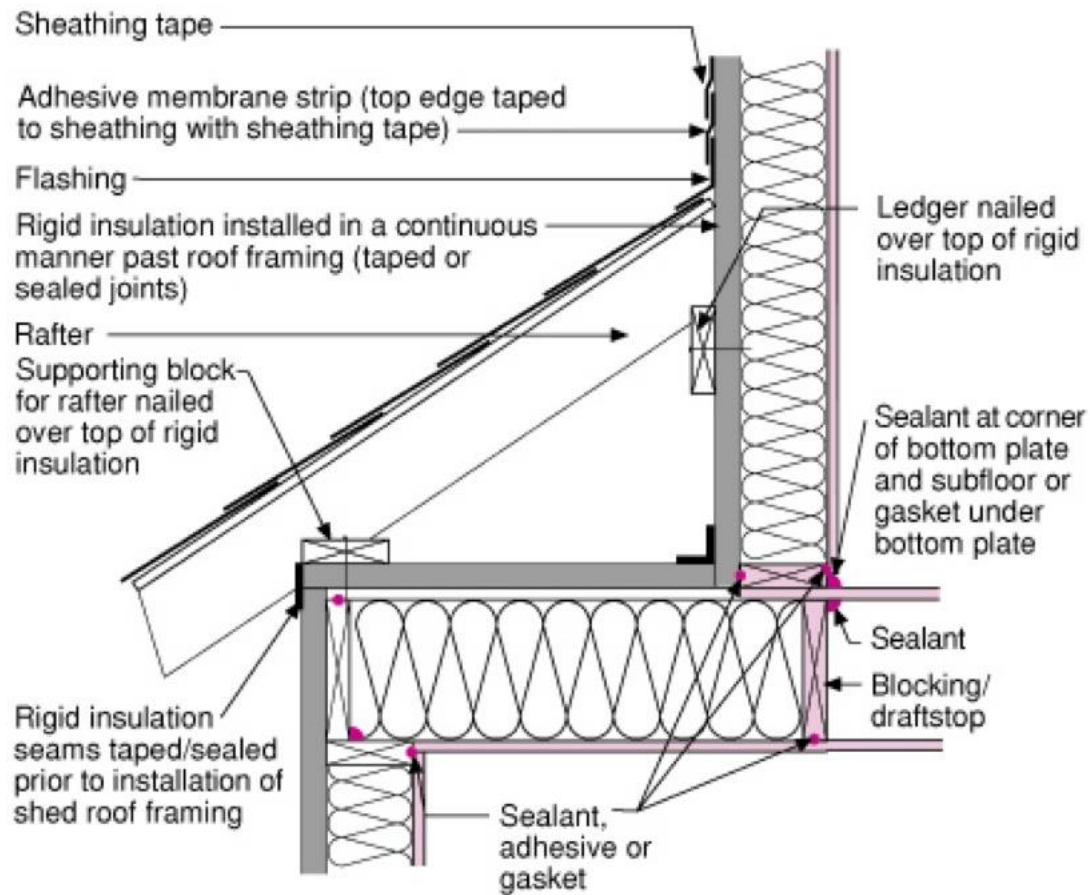

# Crawl Spaces

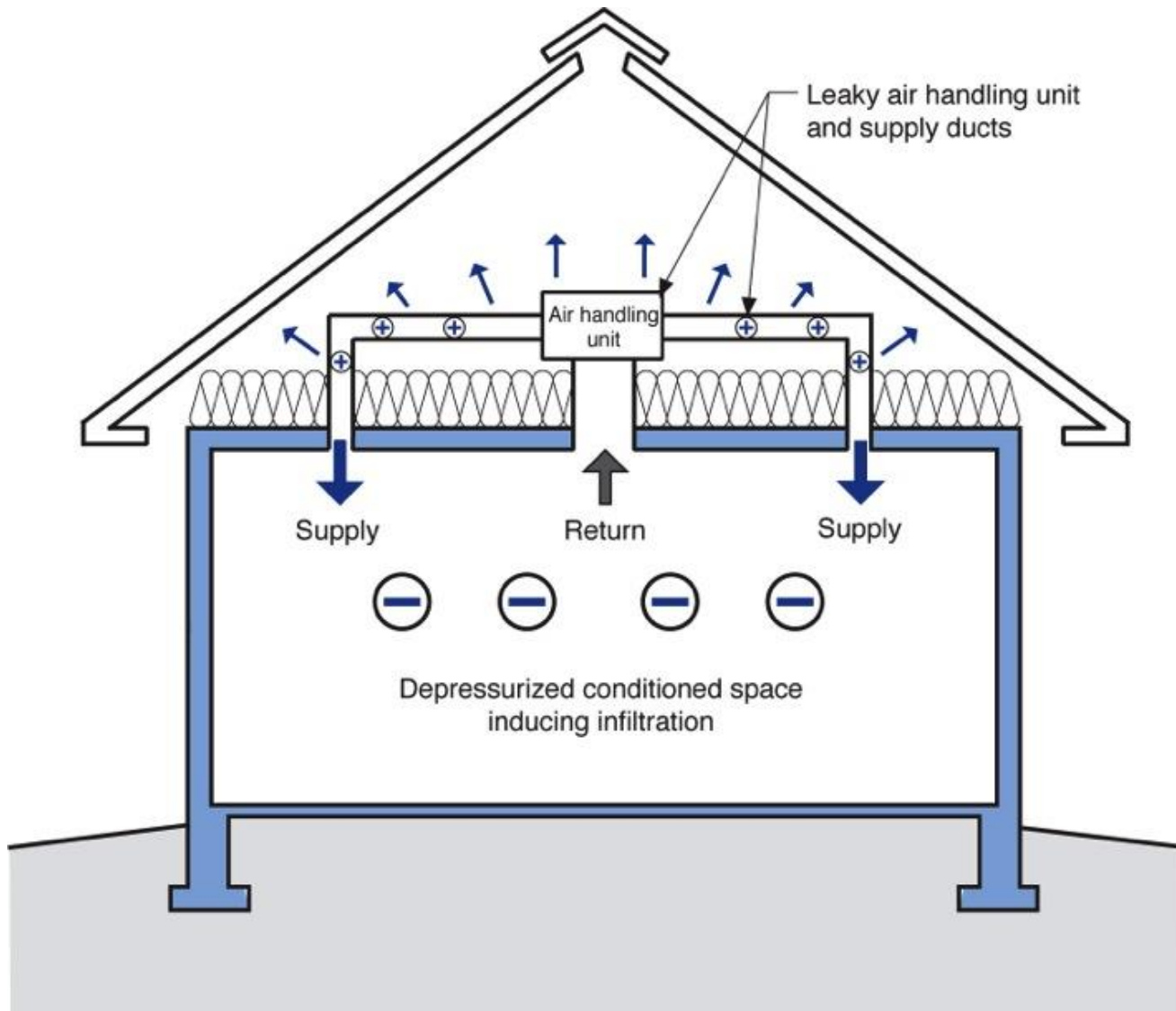

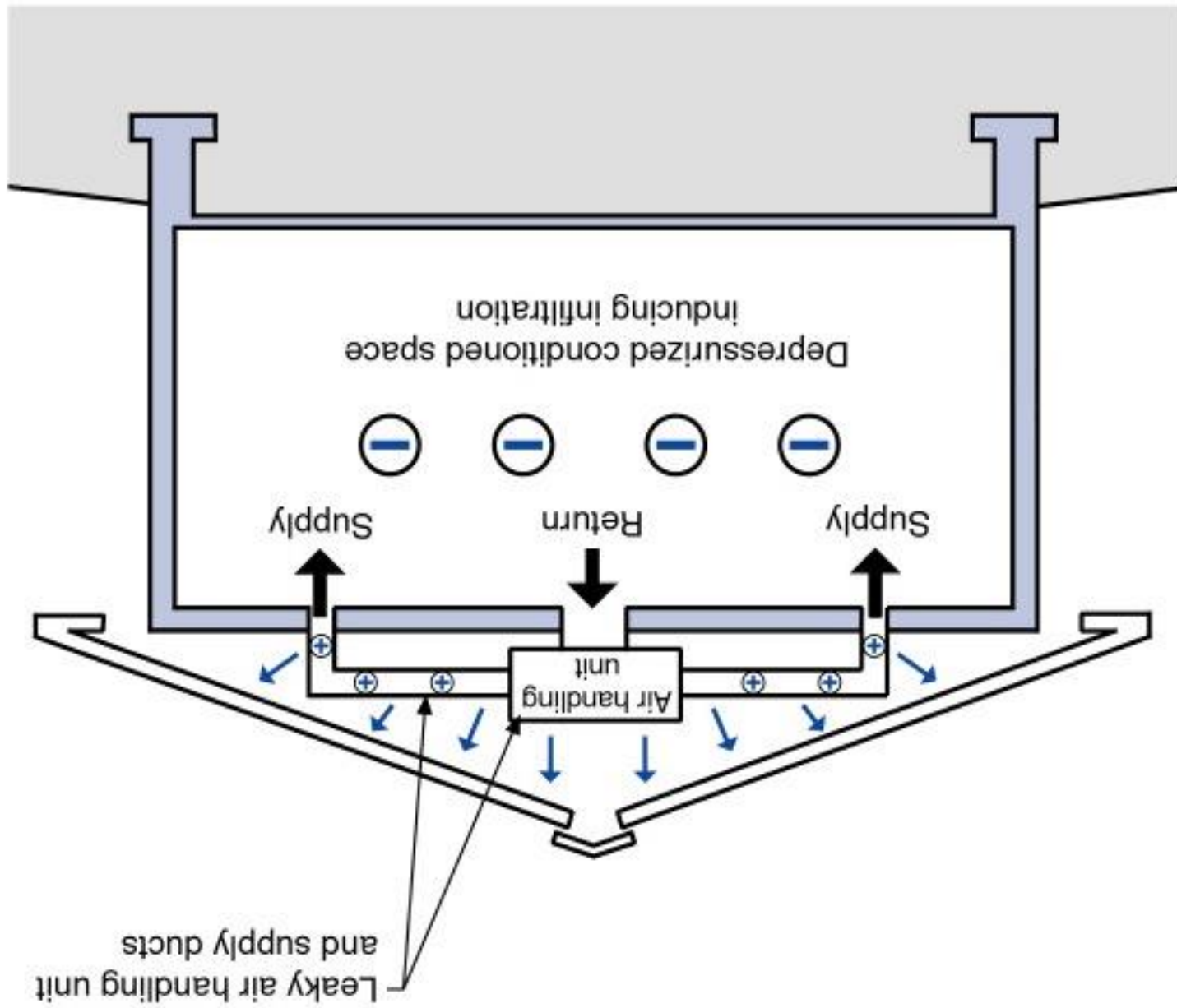

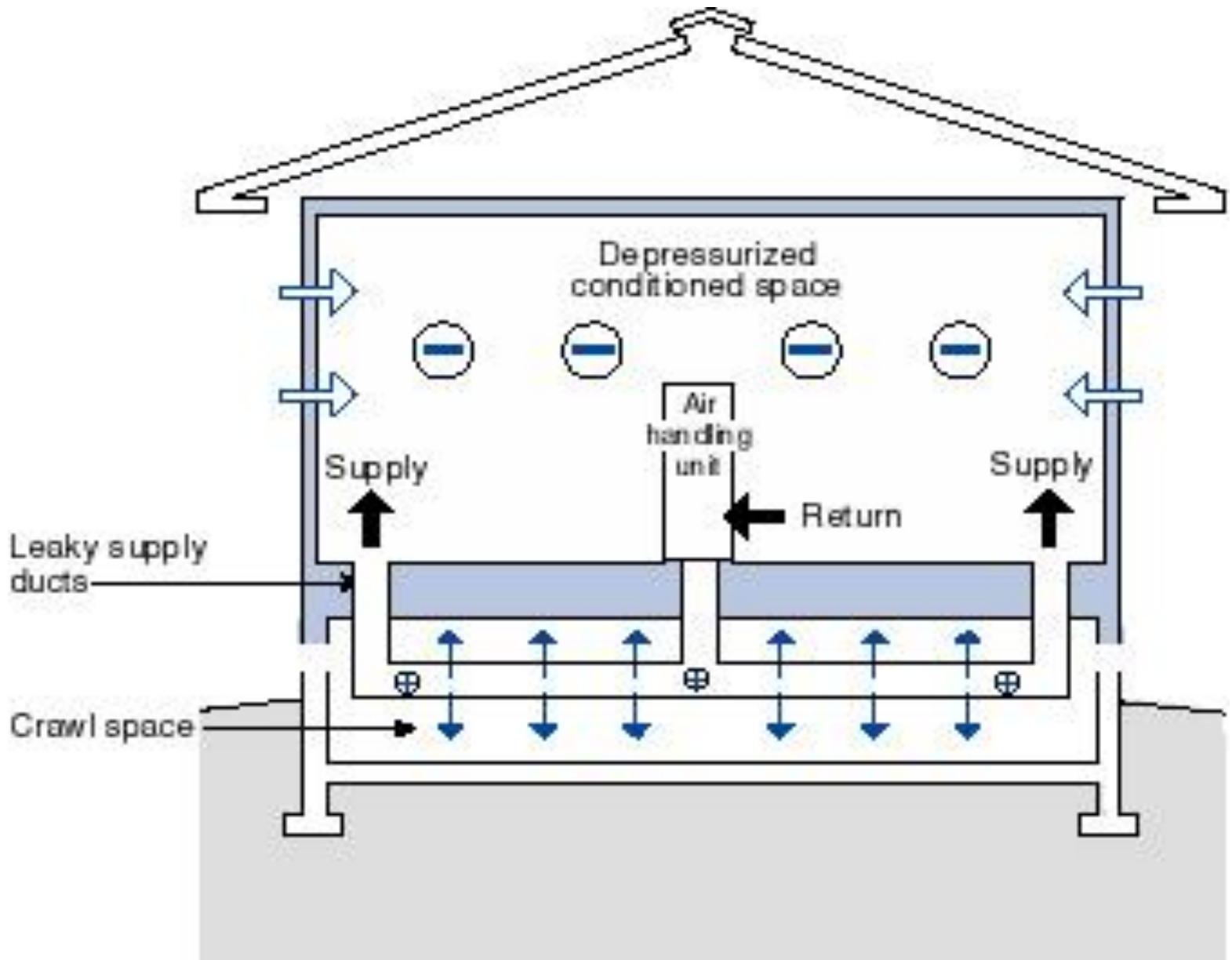





Conditioned Crawlspace Not Unvented  
Crawlspace

Need Supply Air

50 cfm/1000 ft<sup>2</sup> of Crawlspace Area

Or

Dehumidification

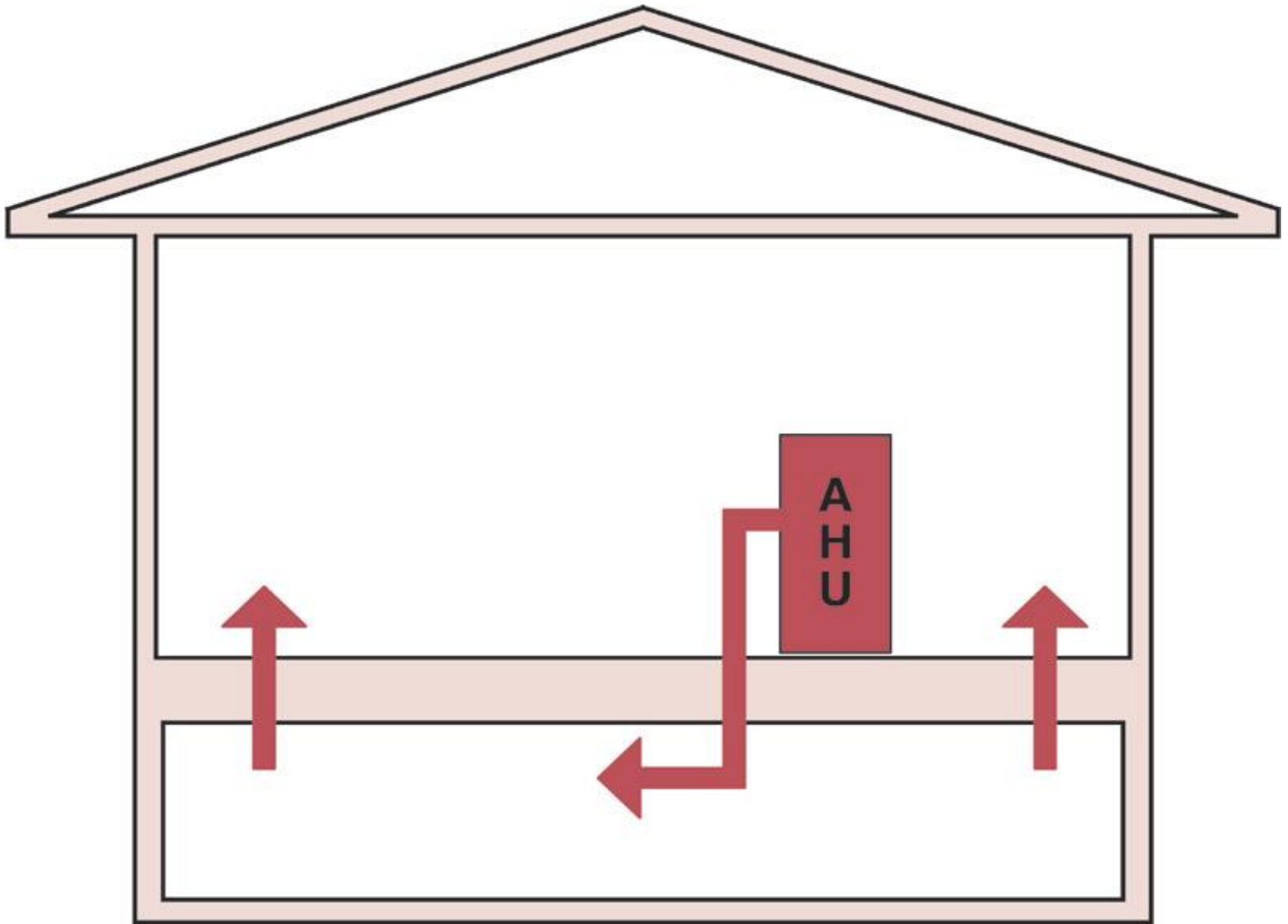

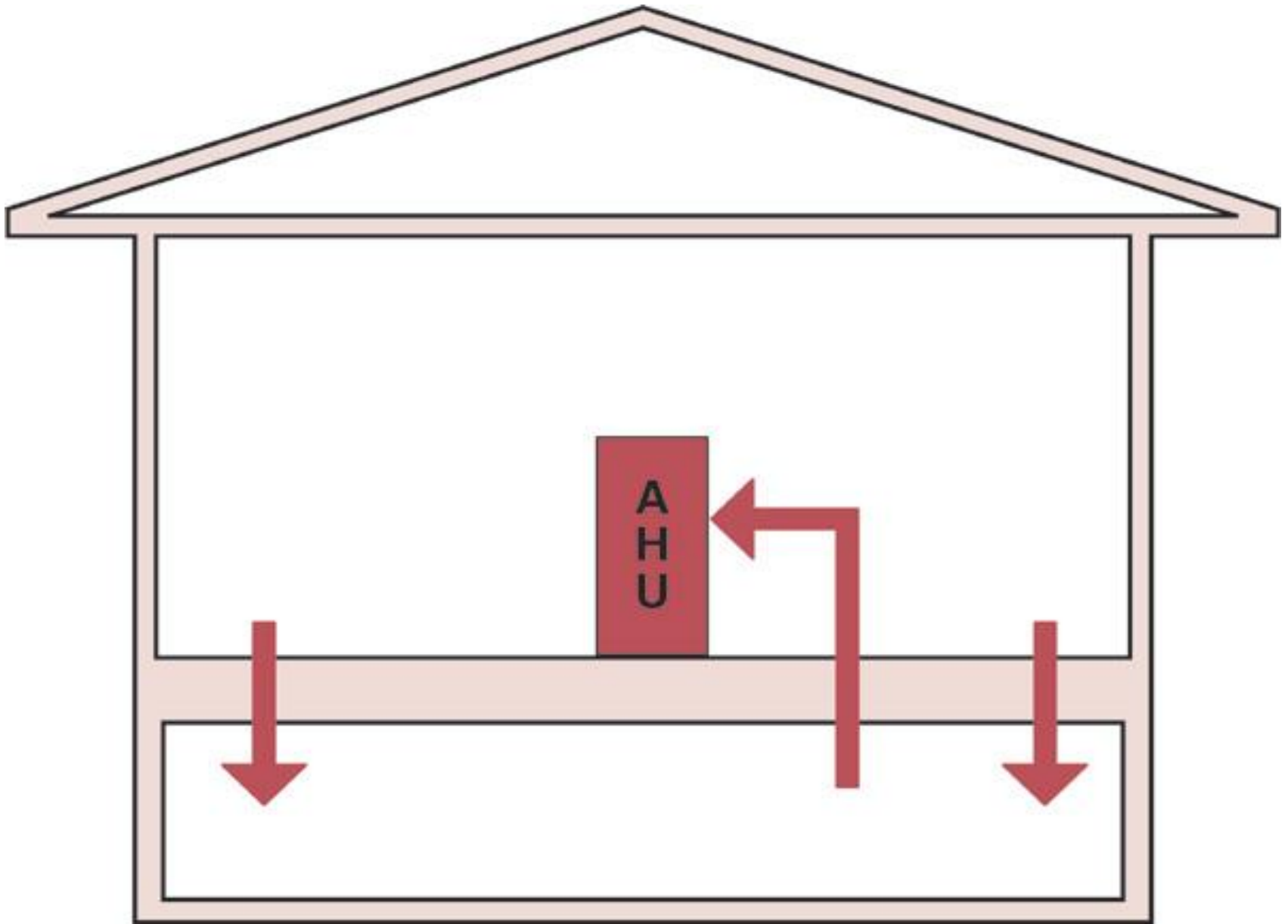

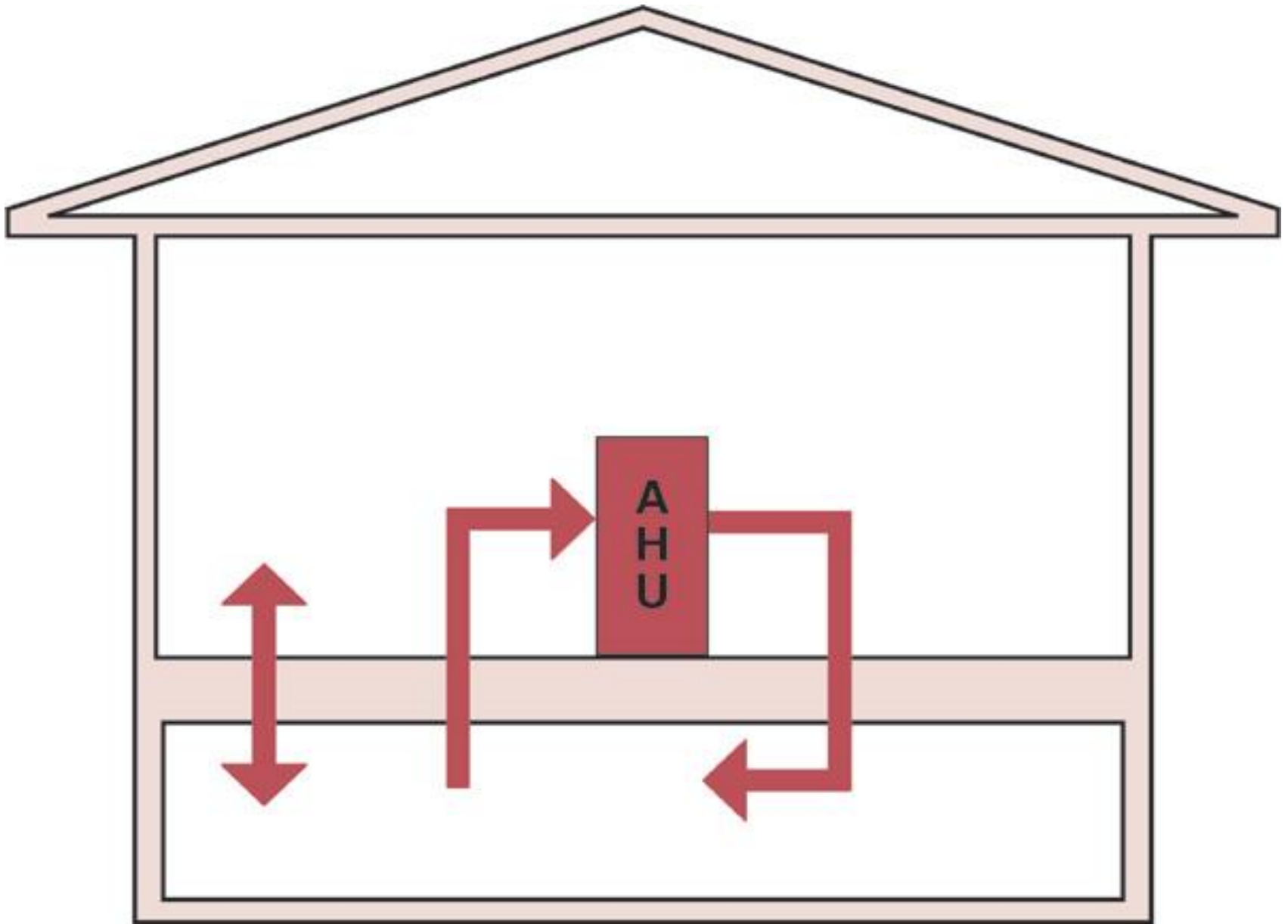

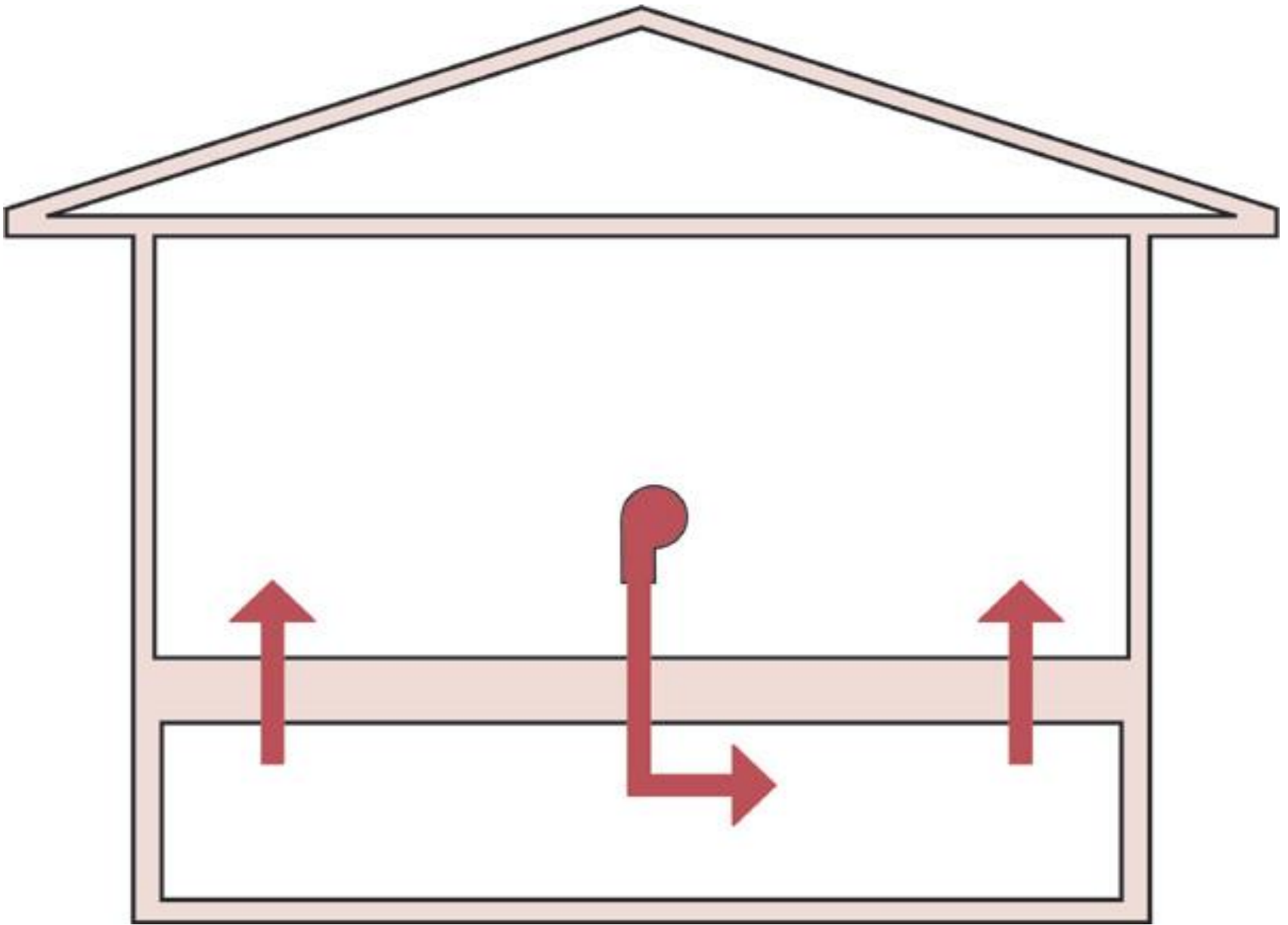

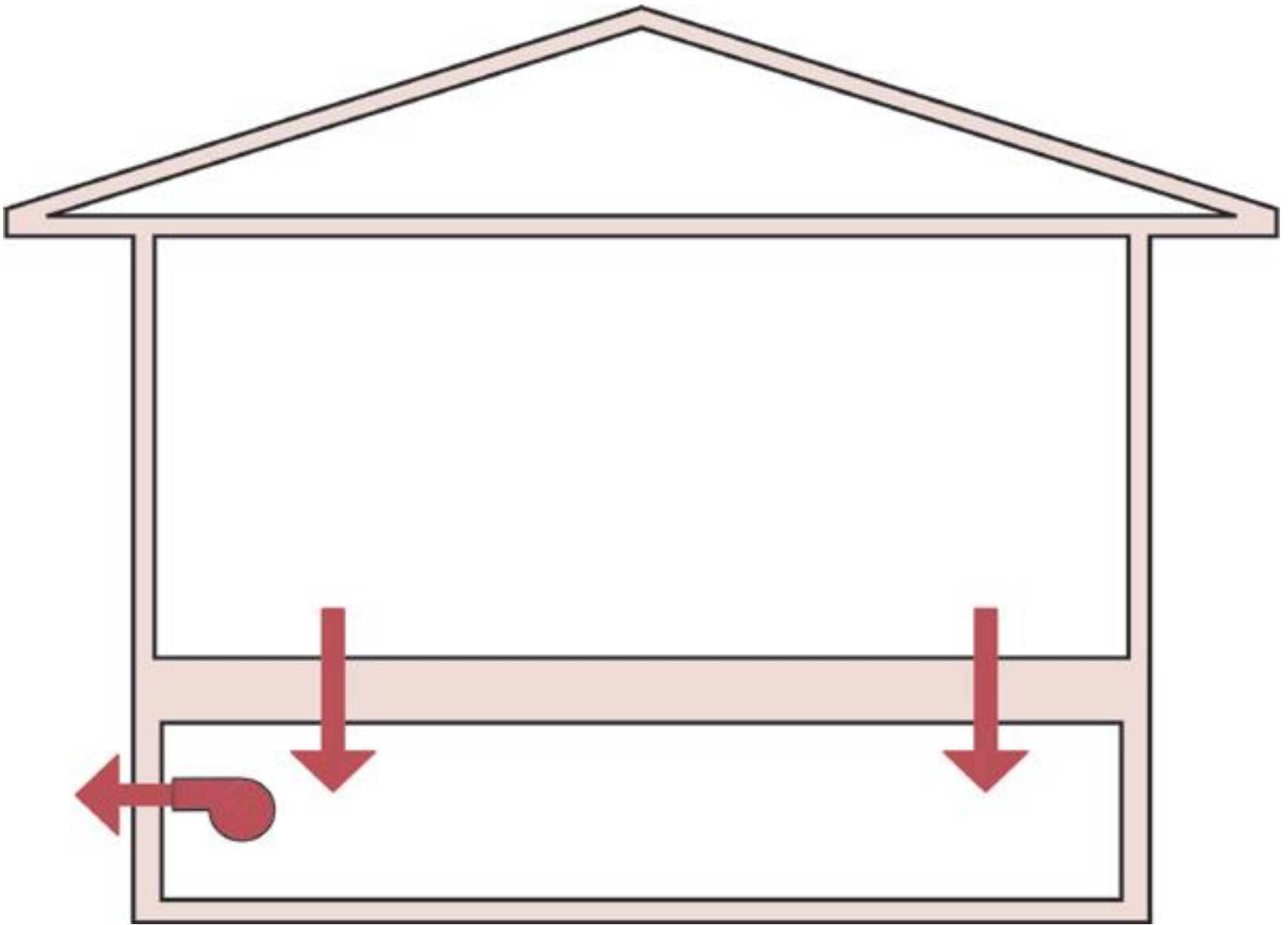

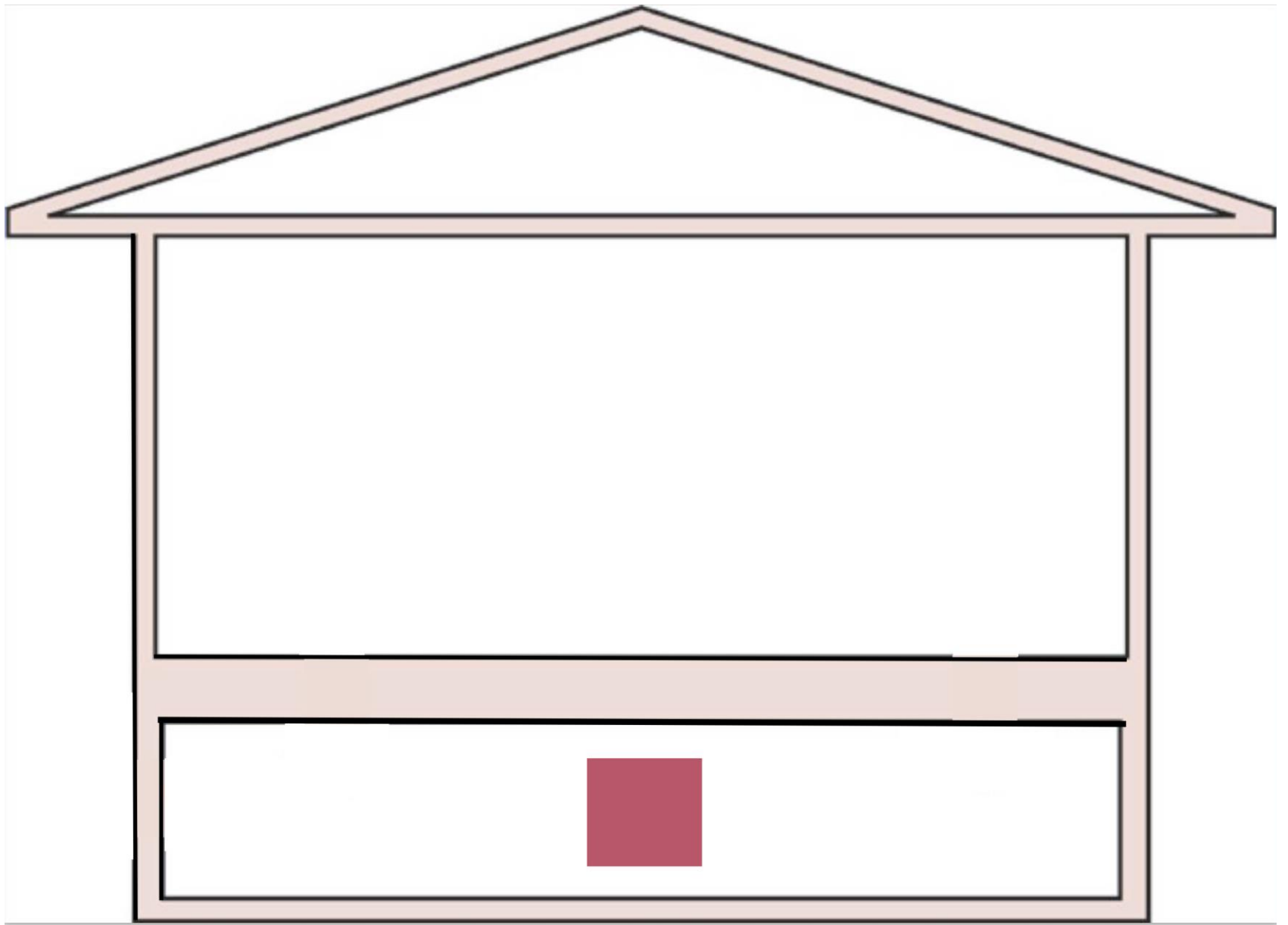



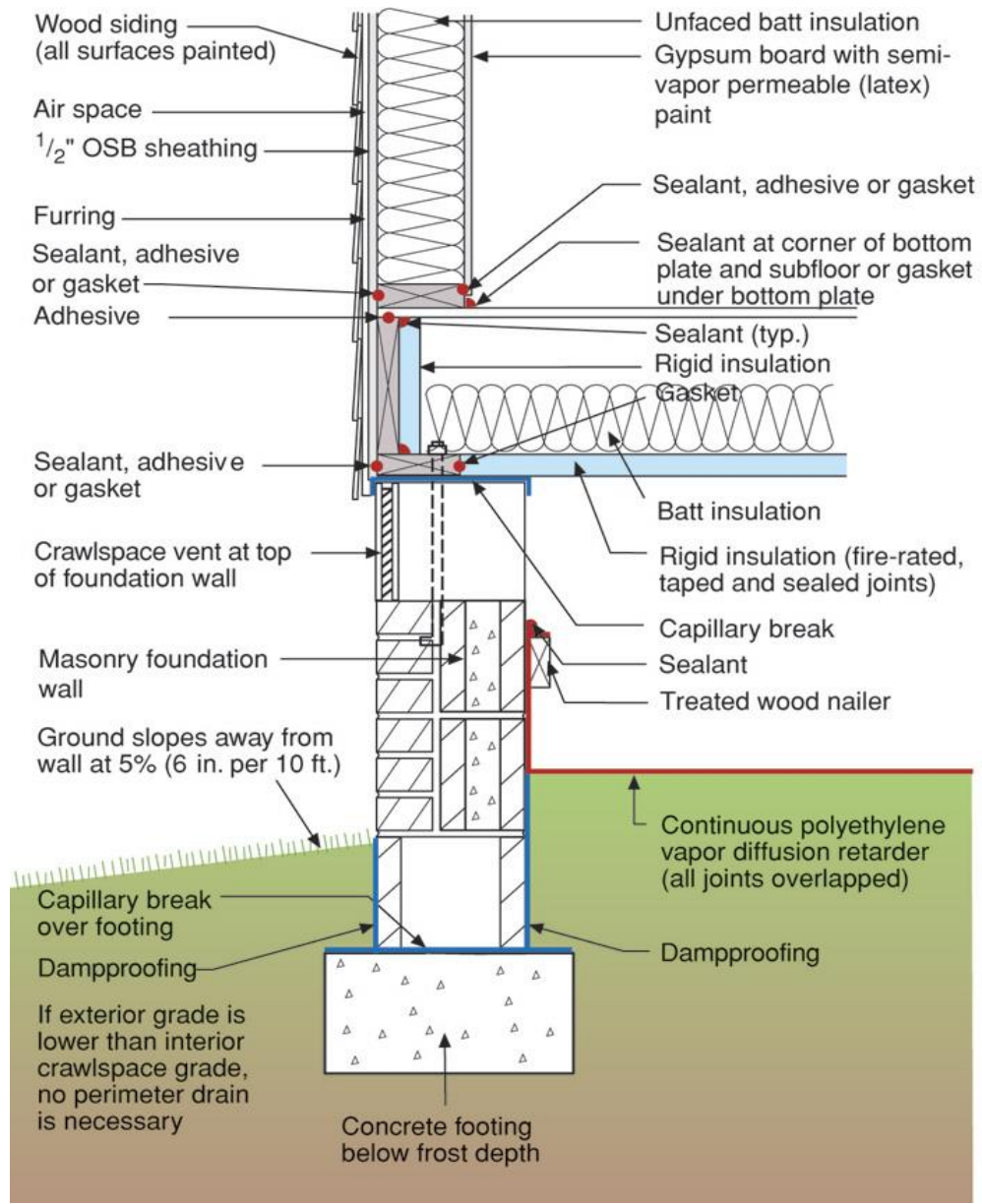

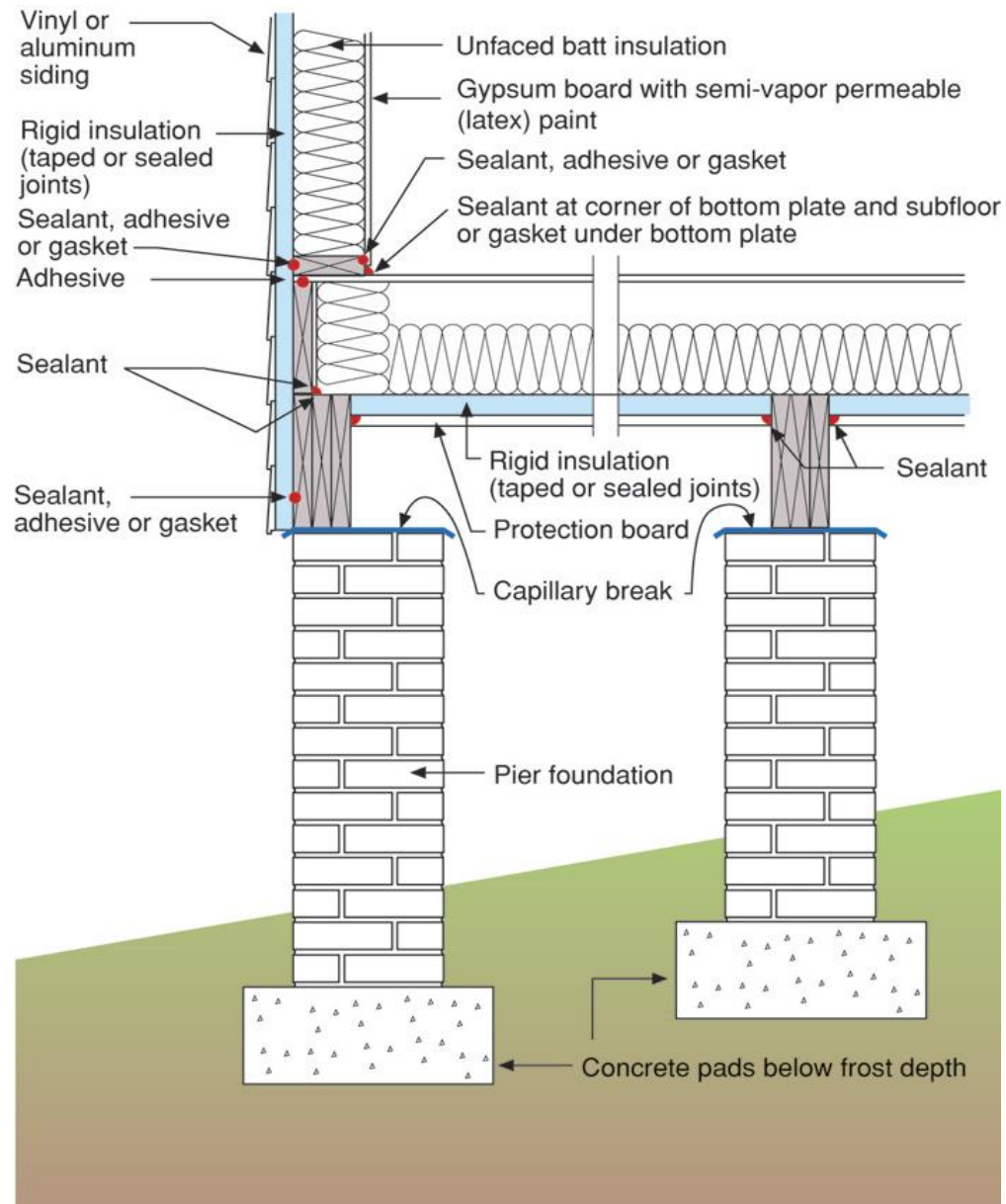

















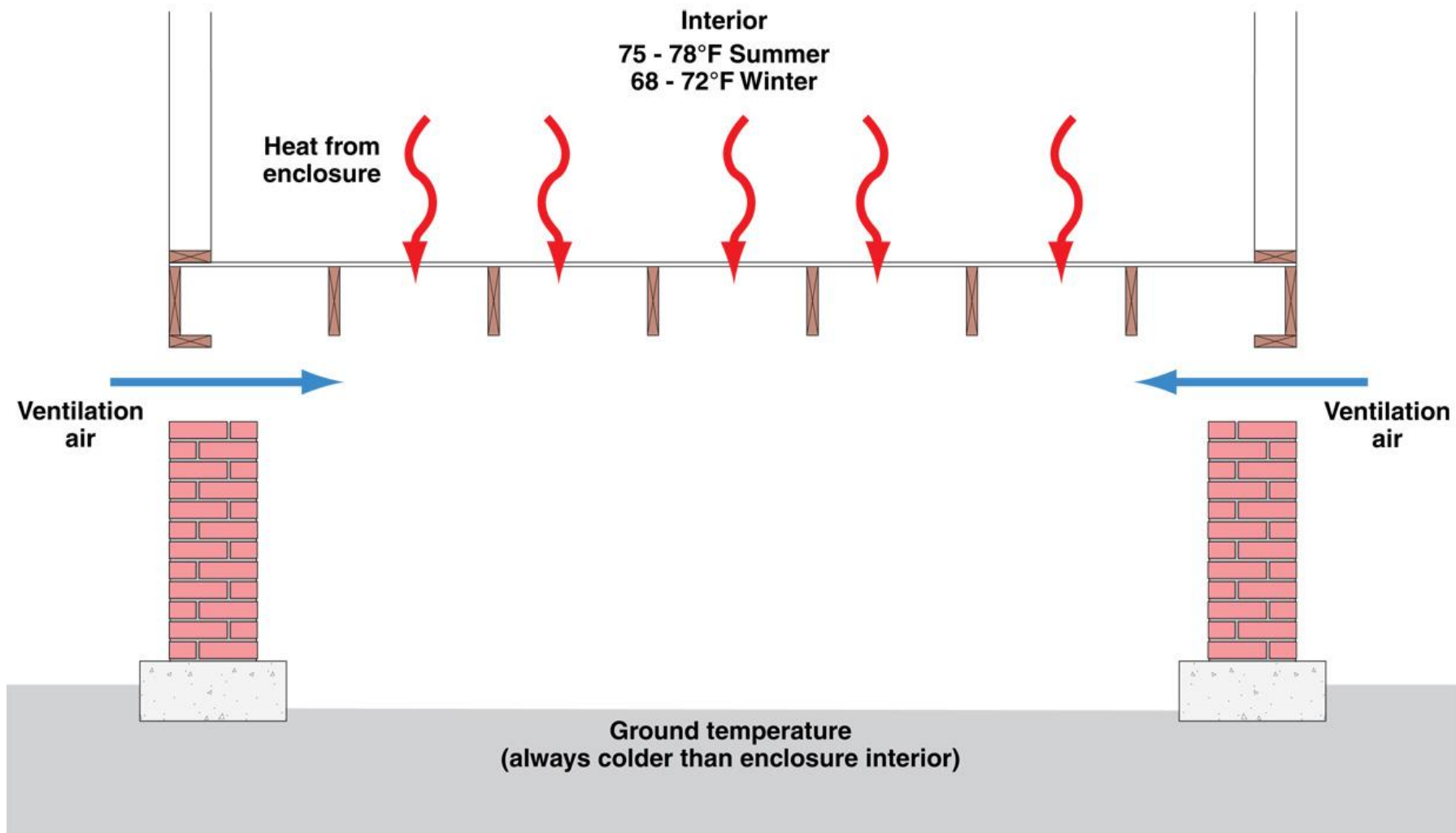

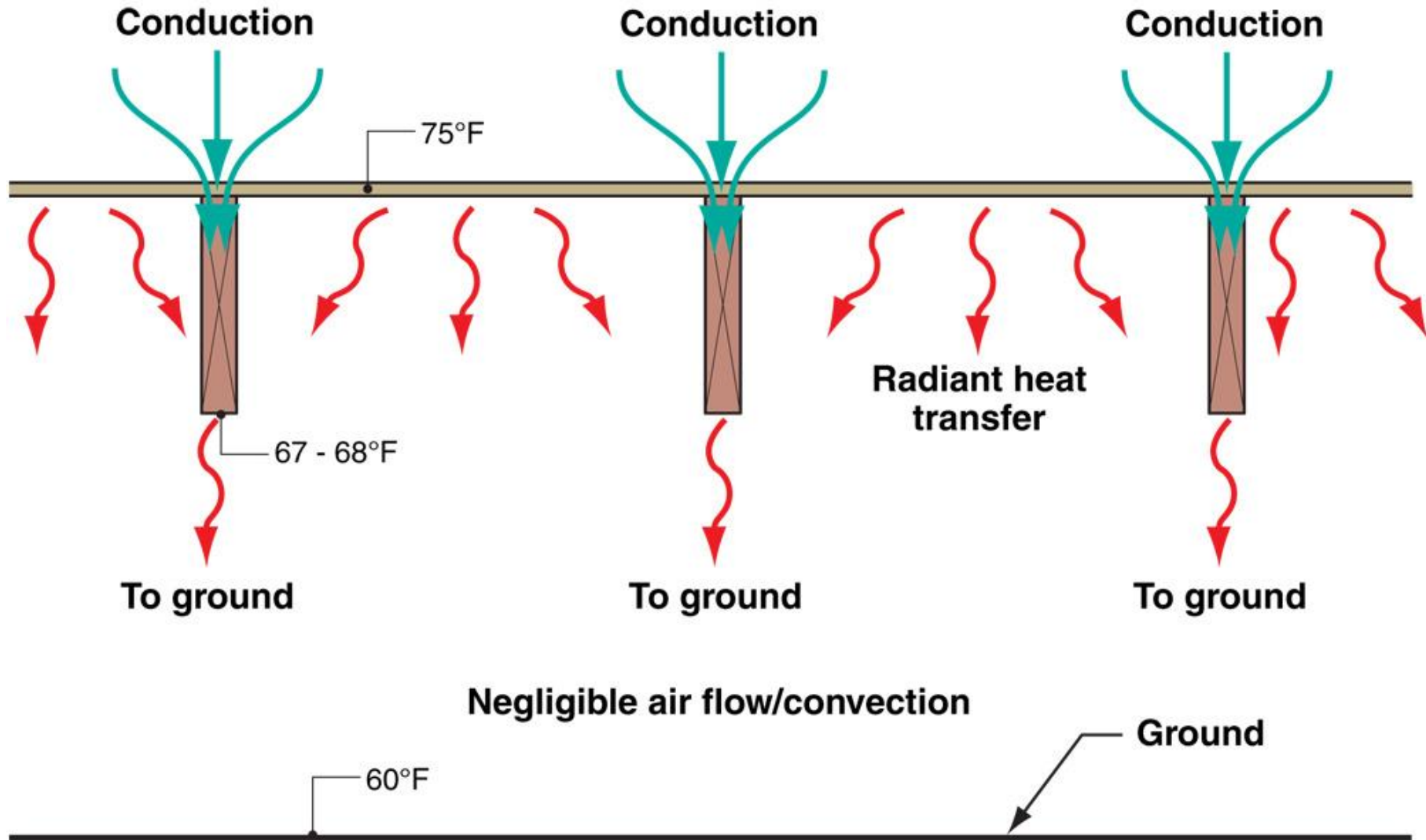

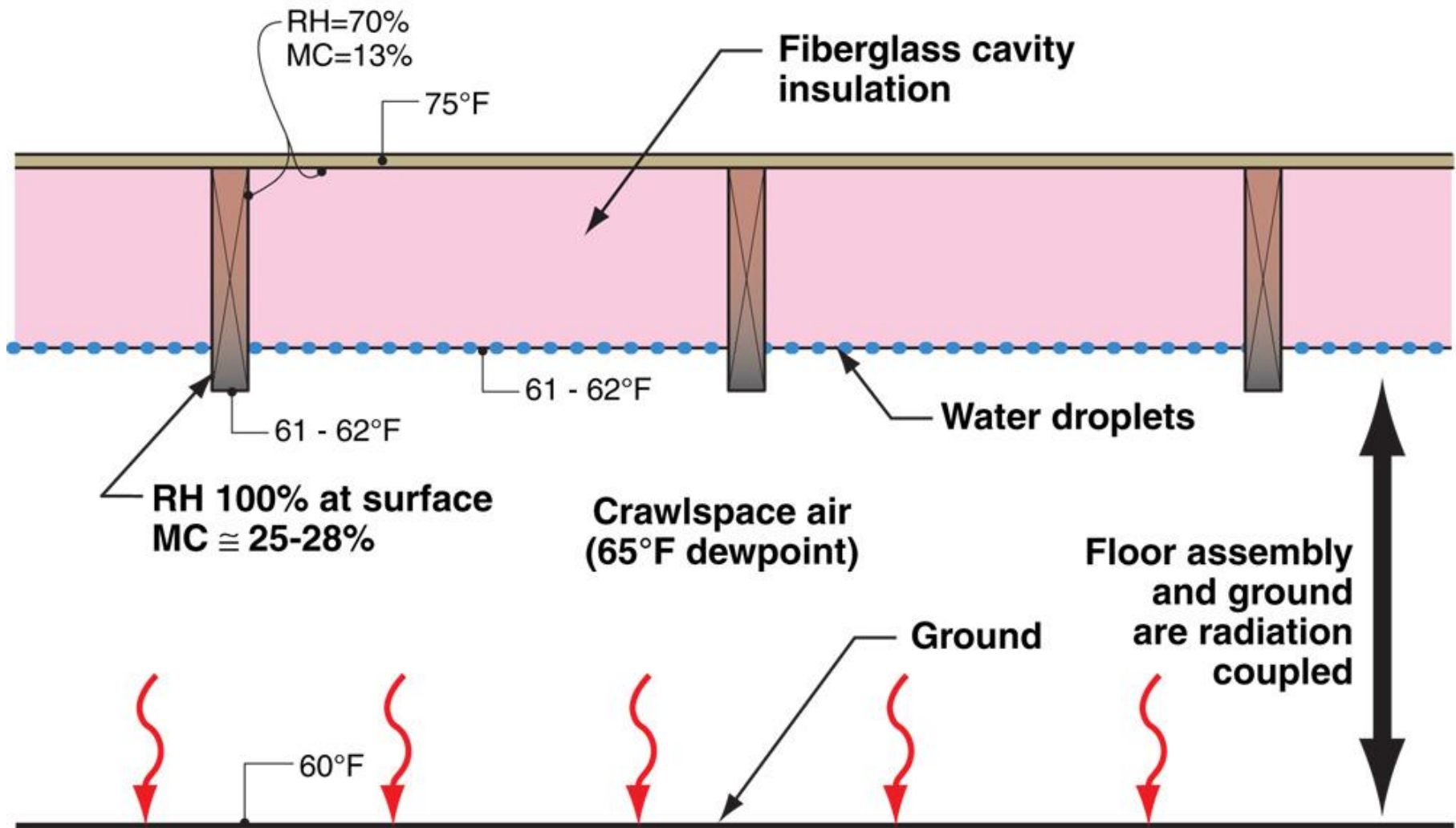

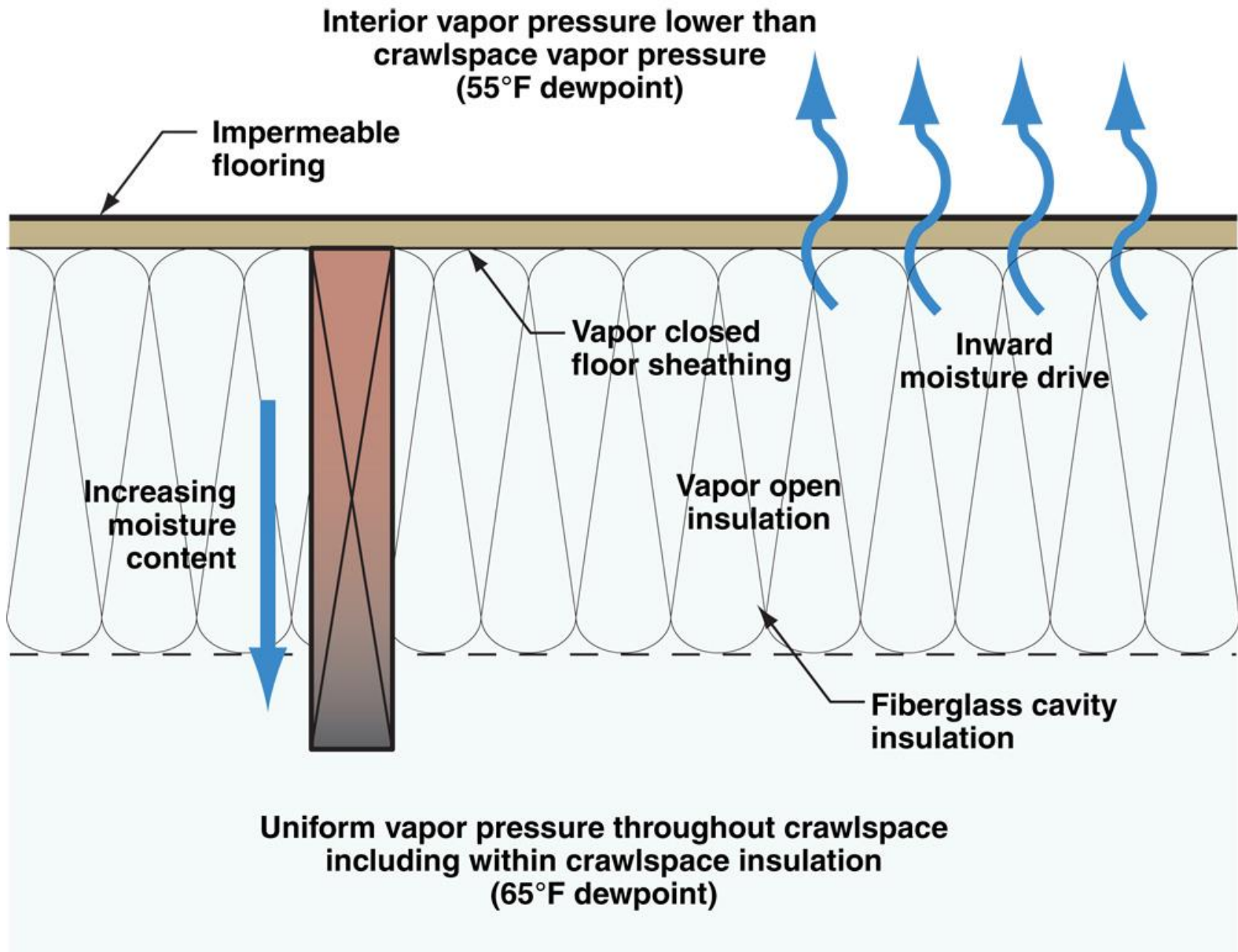





# Back to Ducts....









Not Easy To Put Them Inside....

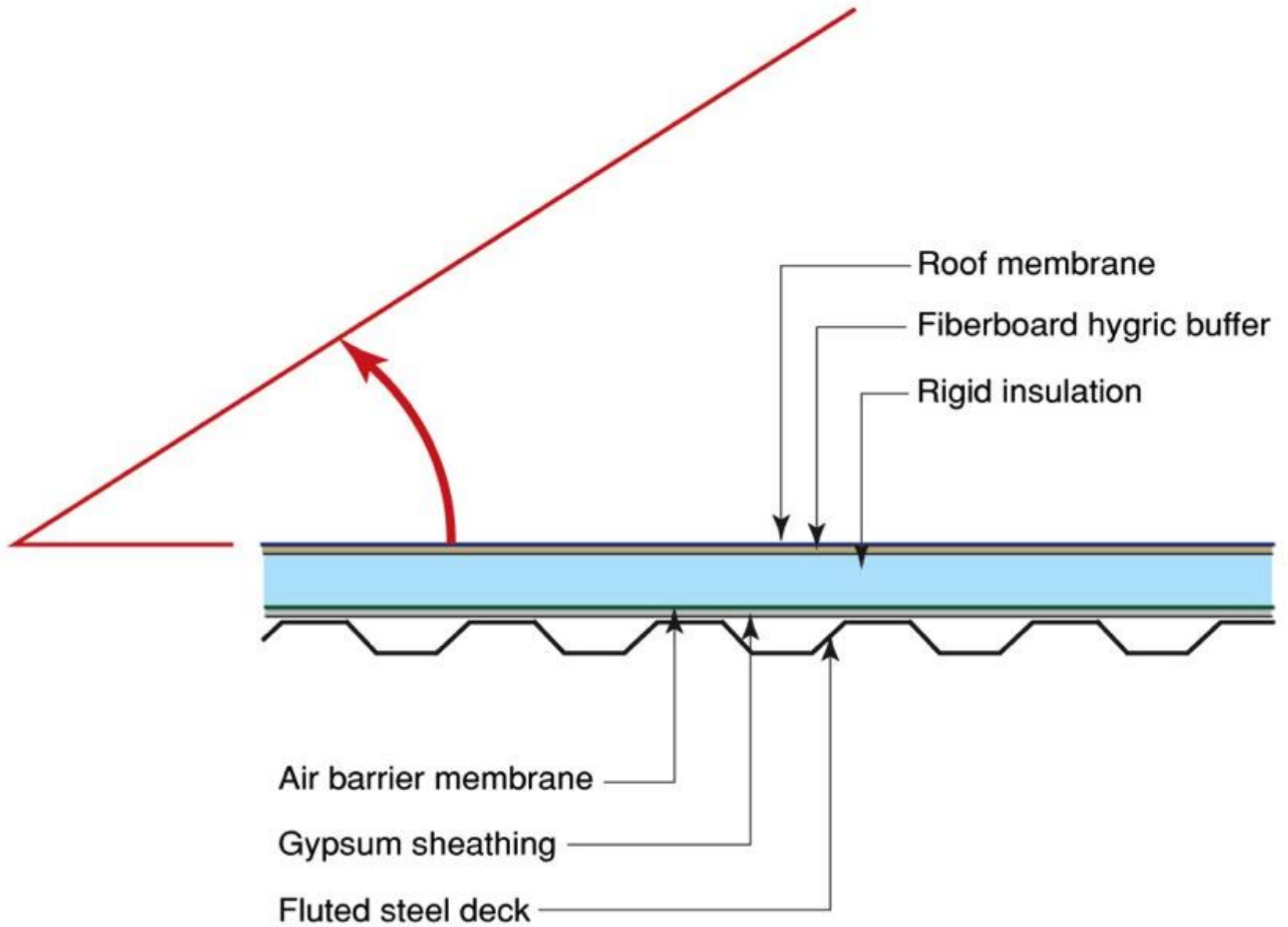

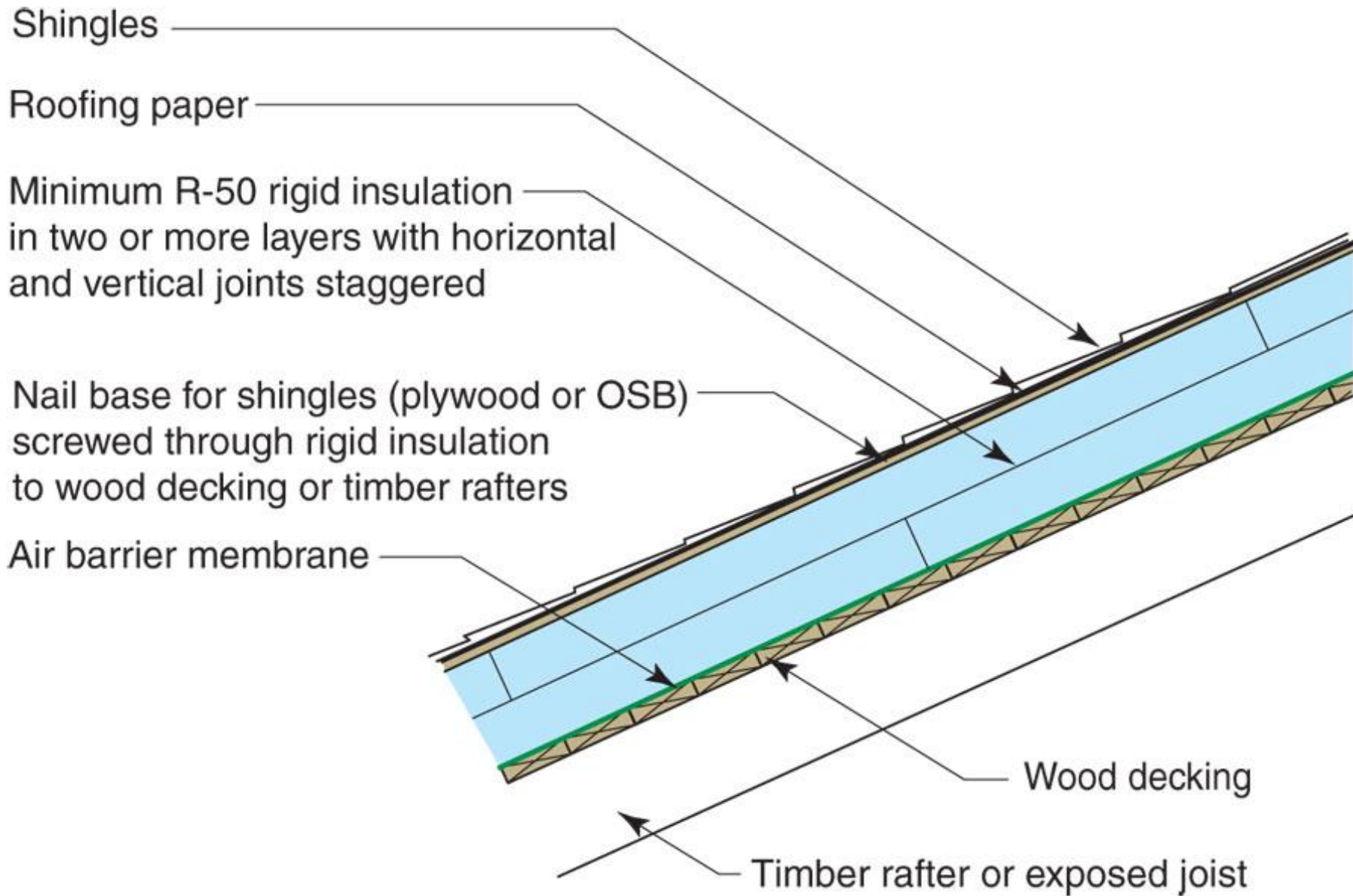

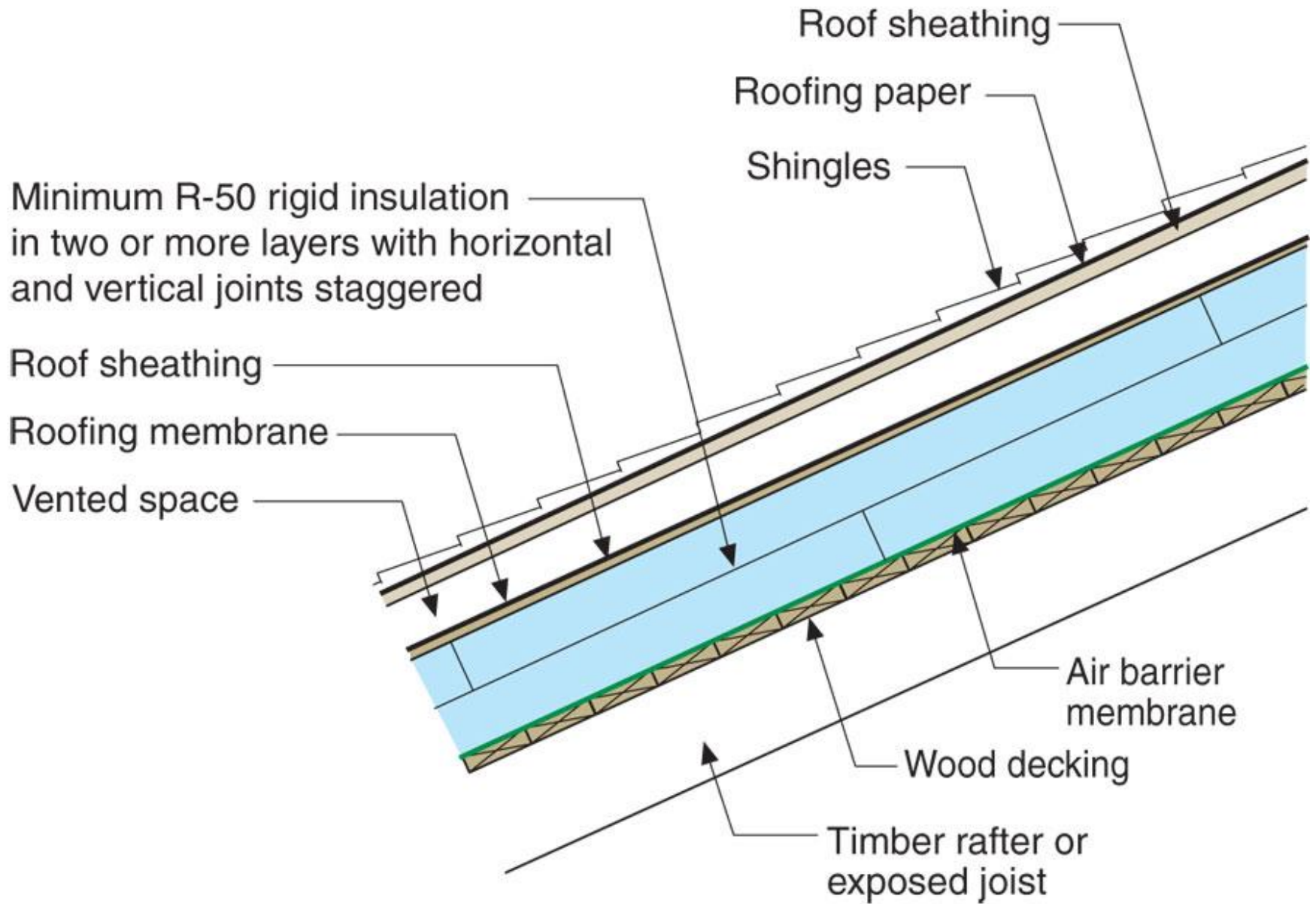

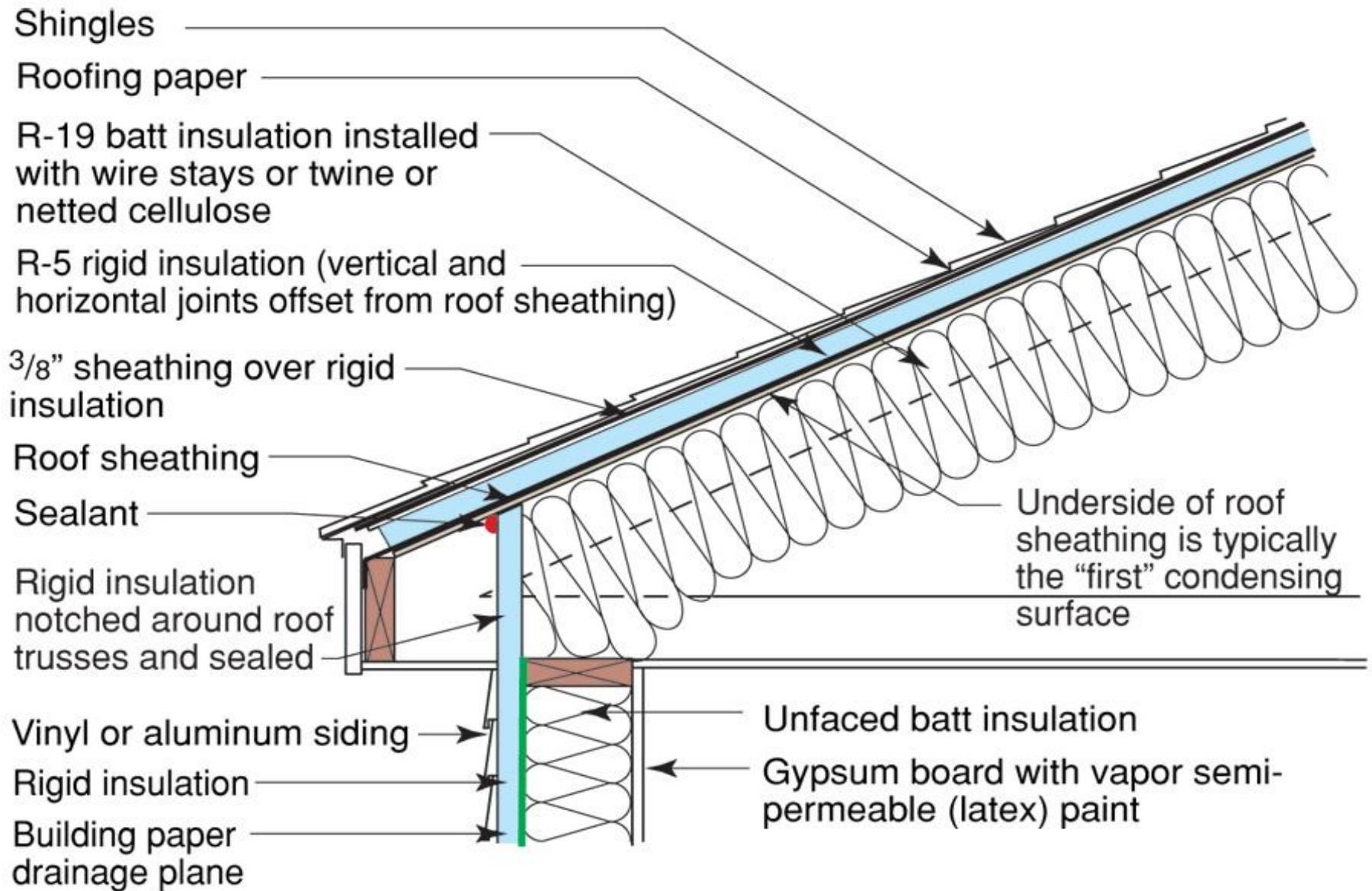



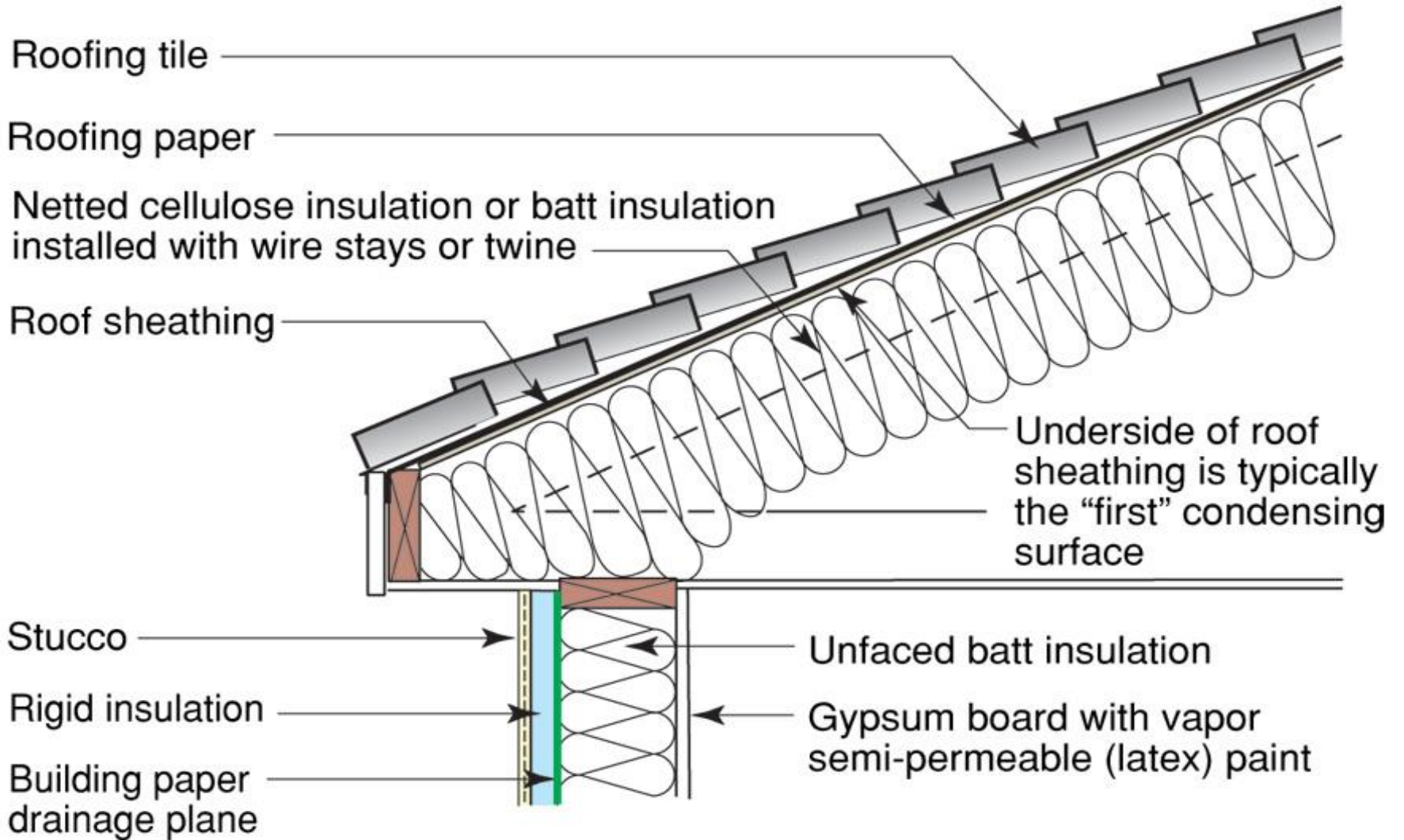







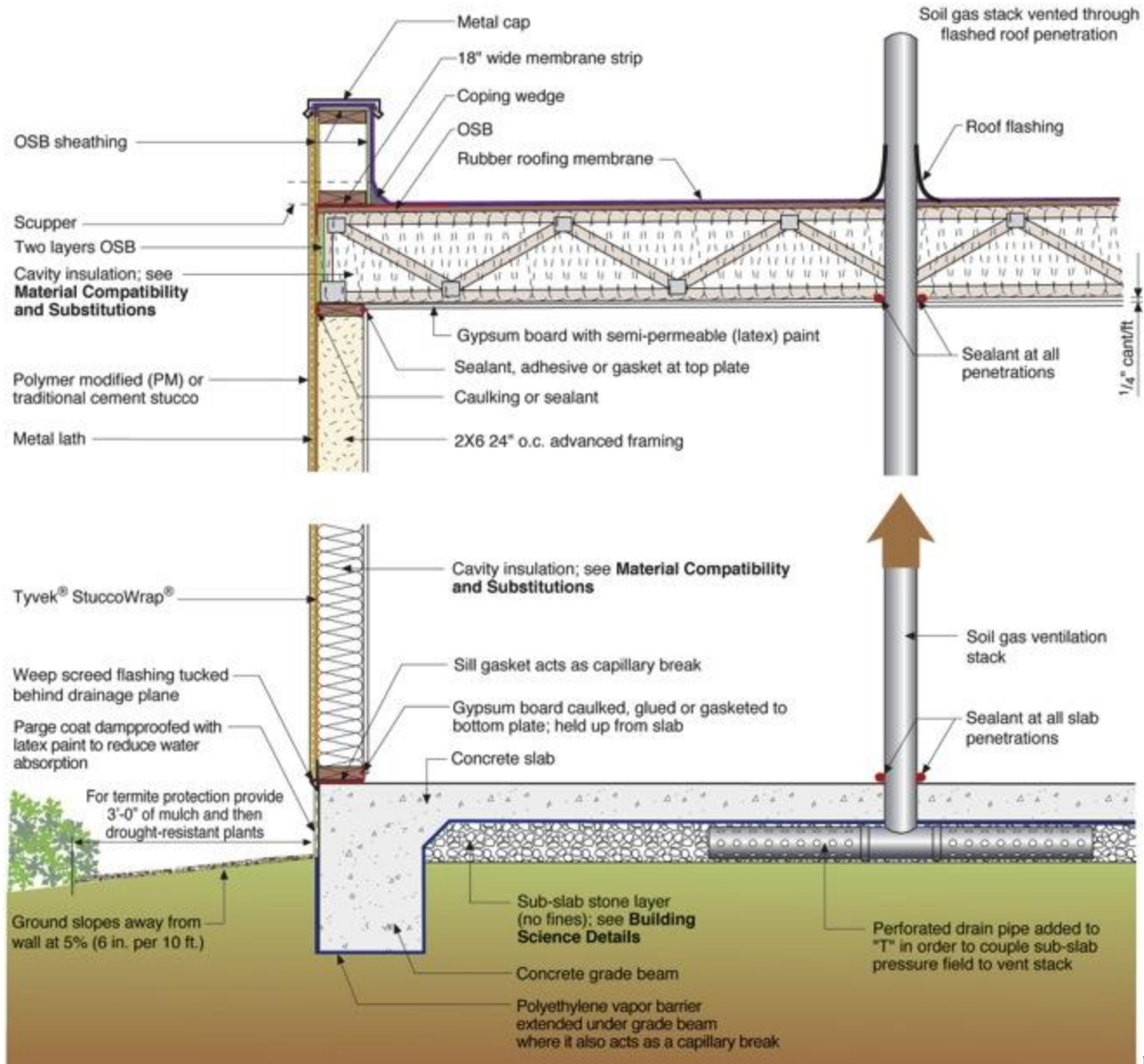

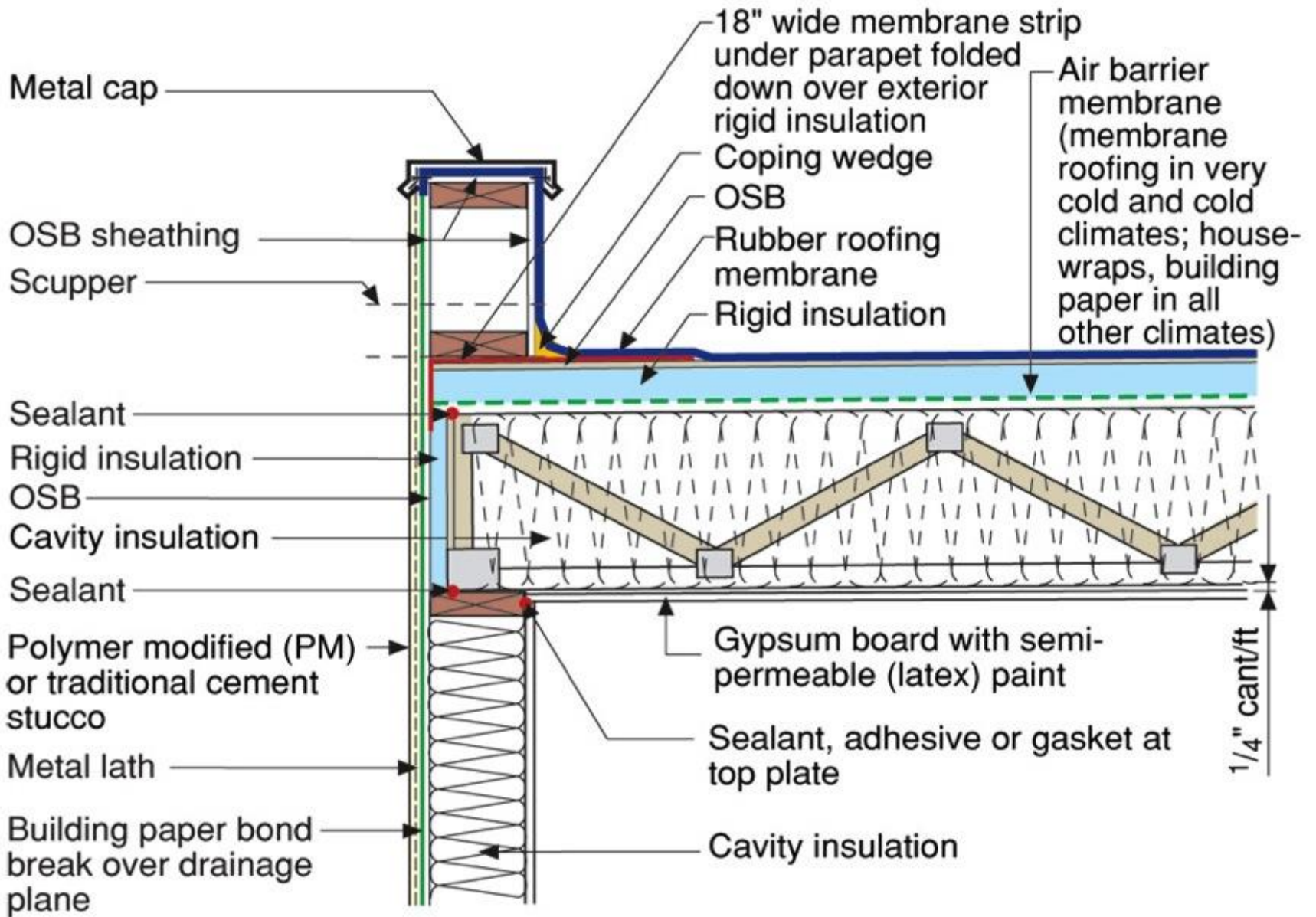

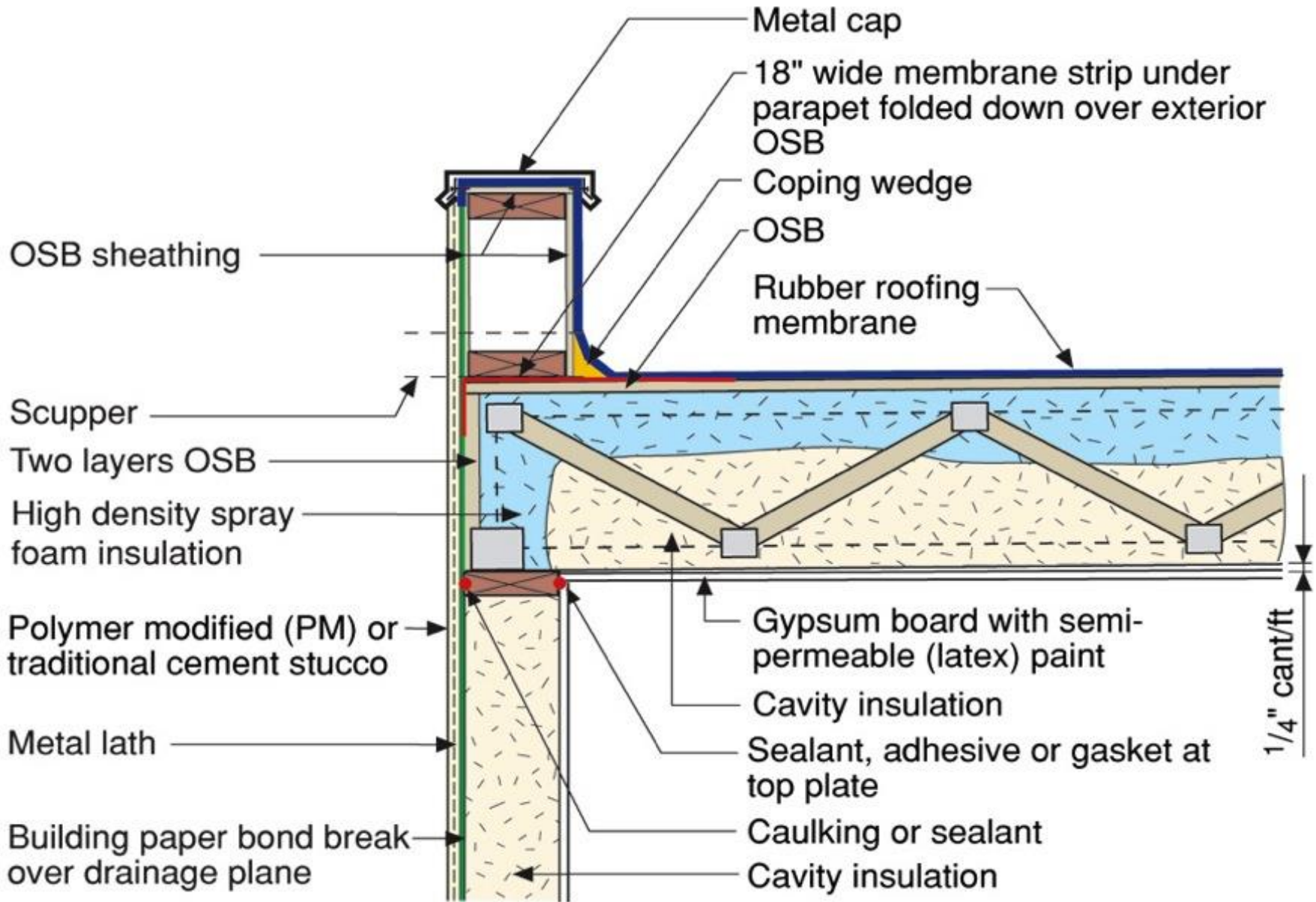

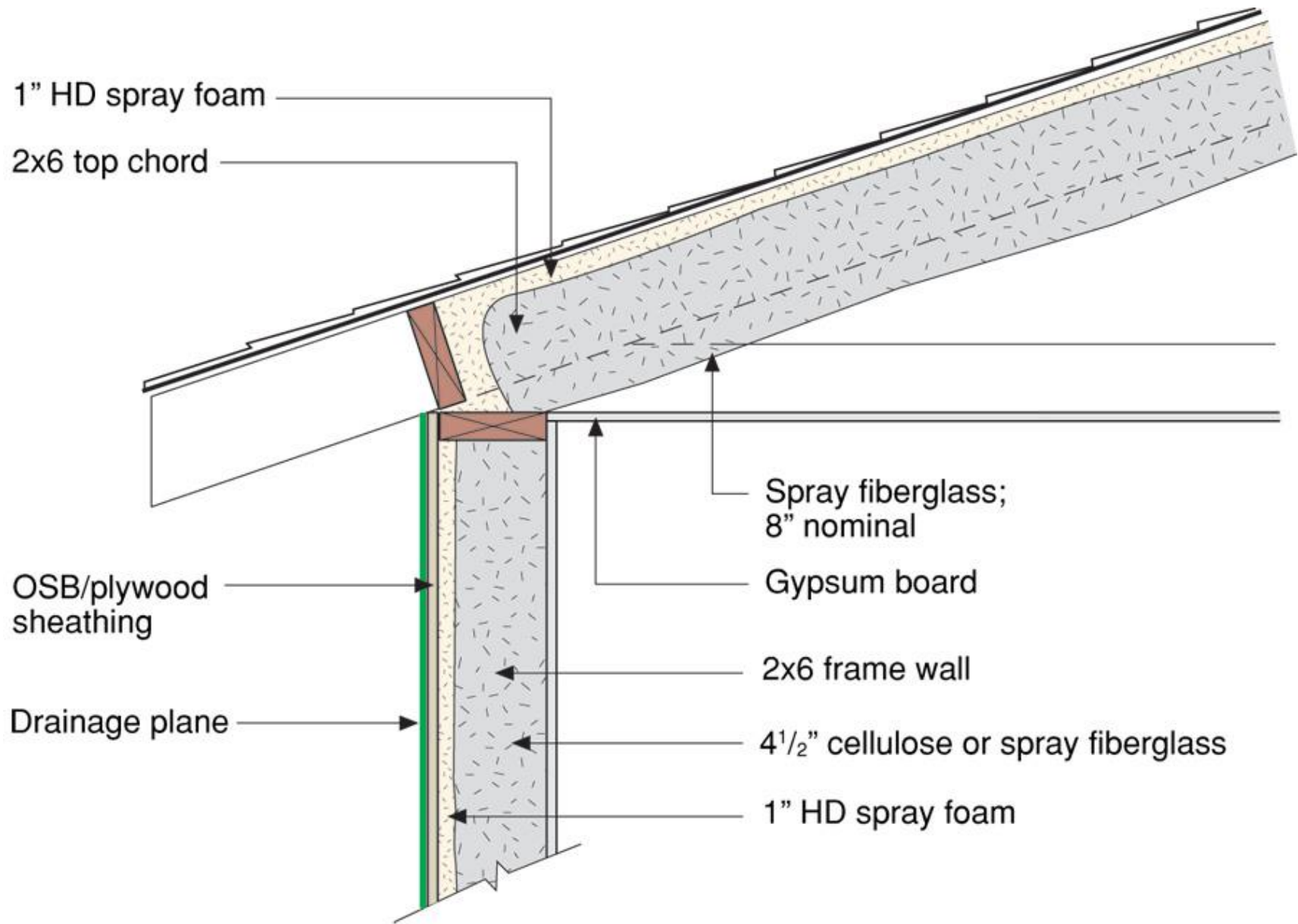



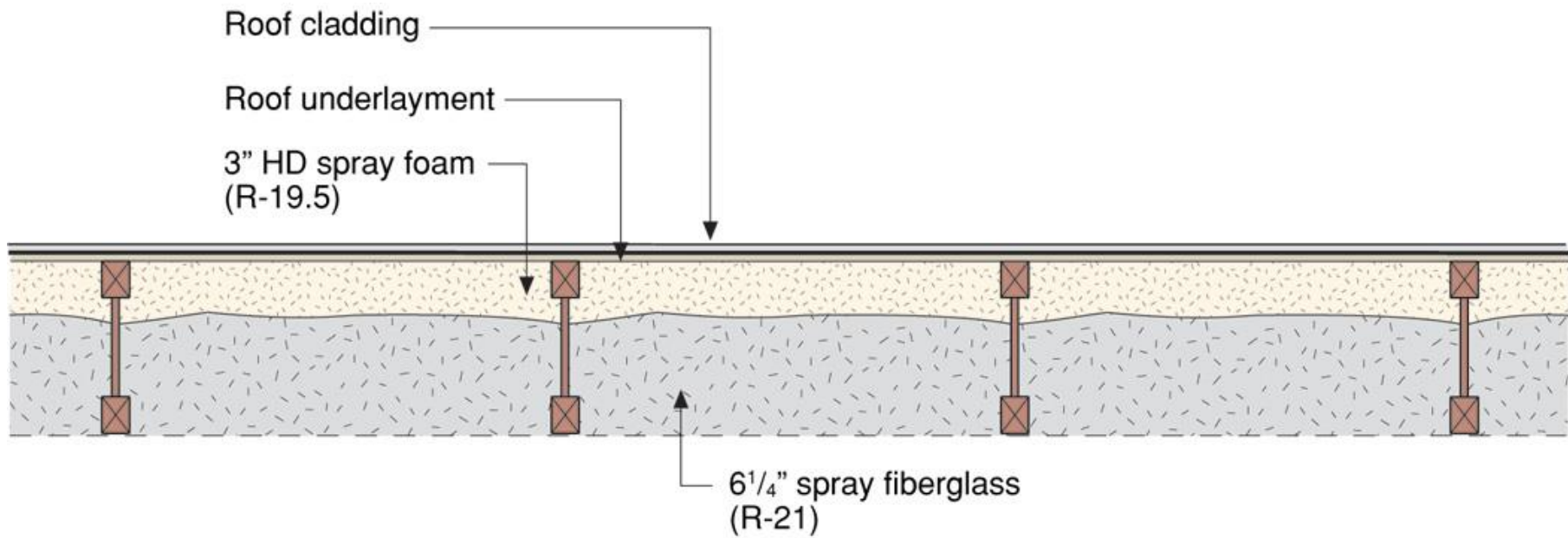

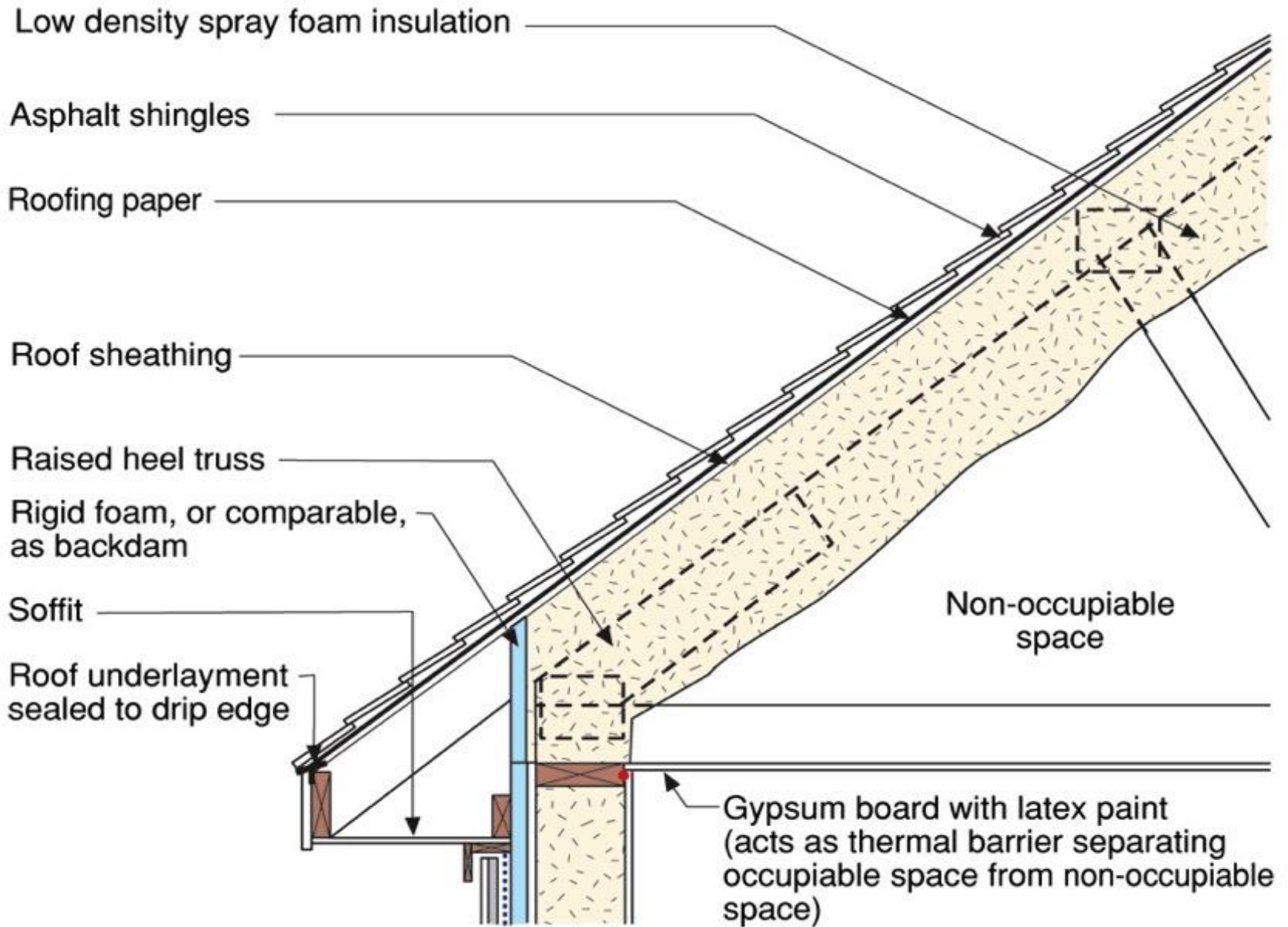









# Map of DOE's Proposed Climate Zones

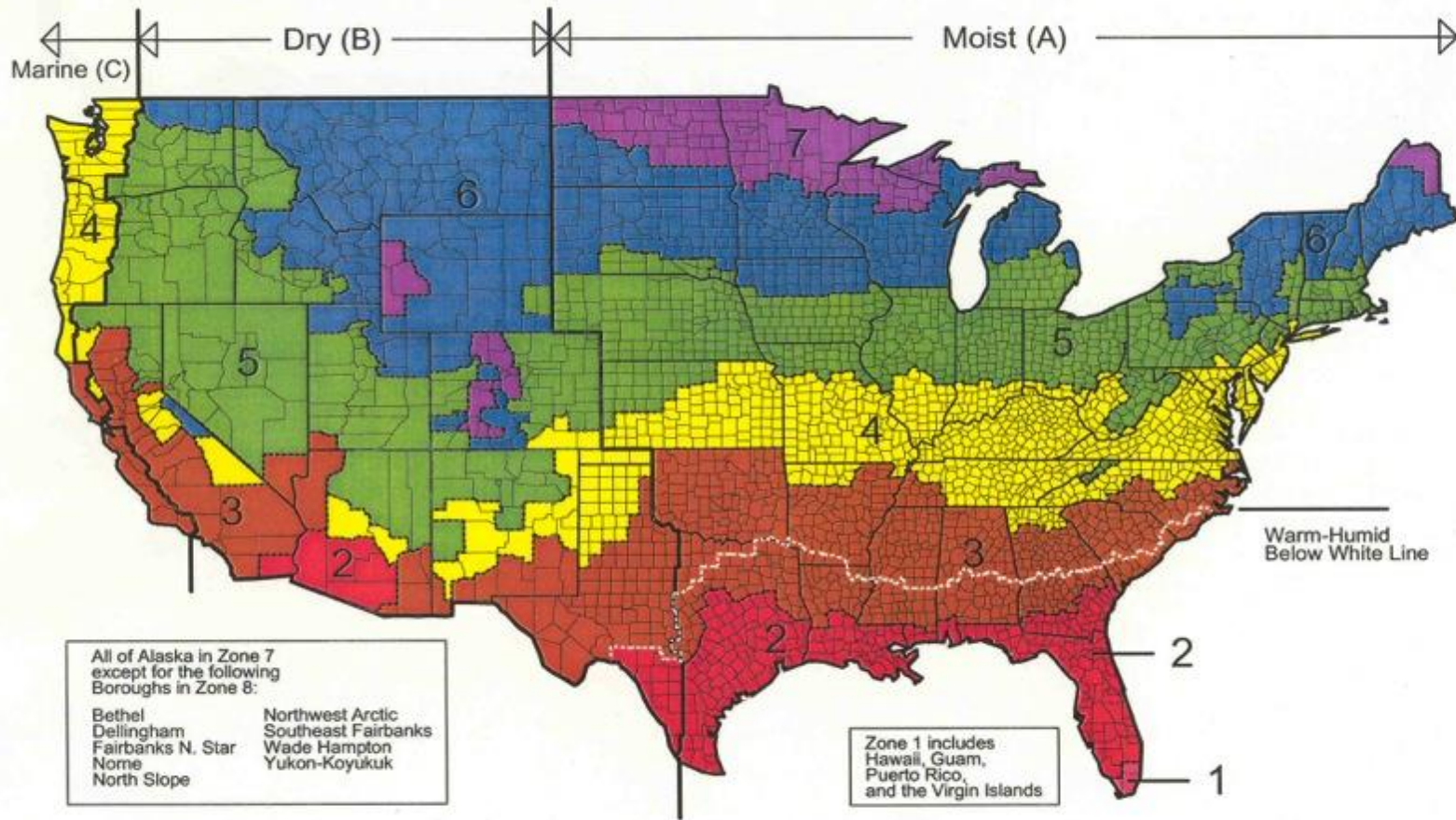

March 24, 2003

# Conditioned Attics Not Unvented Attics



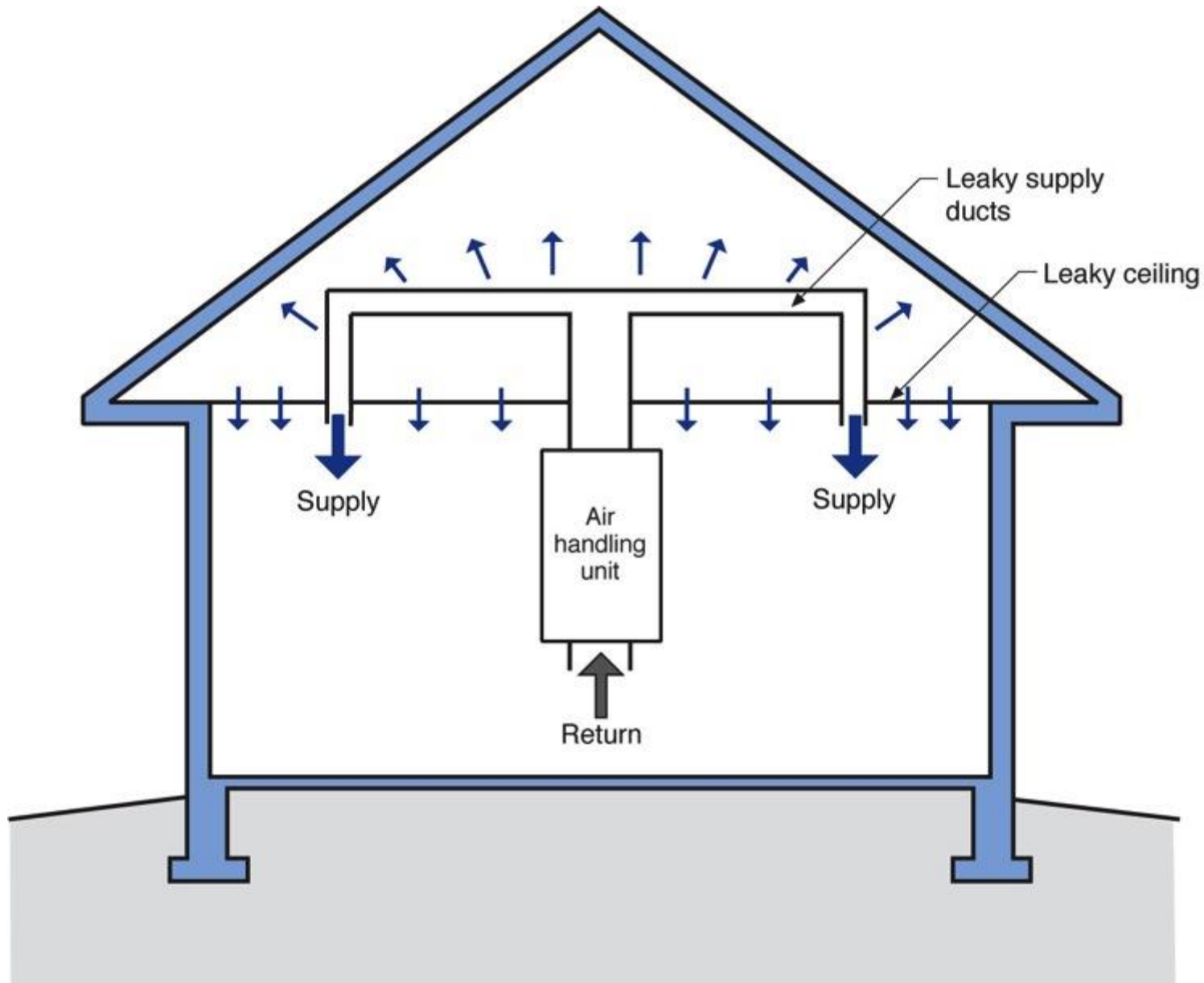



# Conditioned Attics Not Unvented Attics Need Supply Air

Conditioned Attics Not Unvented Attics  
Need Supply Air  
50 cfm/1000 ft<sup>2</sup> of Attic

Conditioned Attics Not Unvented Attics  
Need Supply Air  
50 cfm/1000 ft<sup>2</sup> of Attic

Or  
Dehumidification

# Low-Density Open-Cell Foam Is The Problem







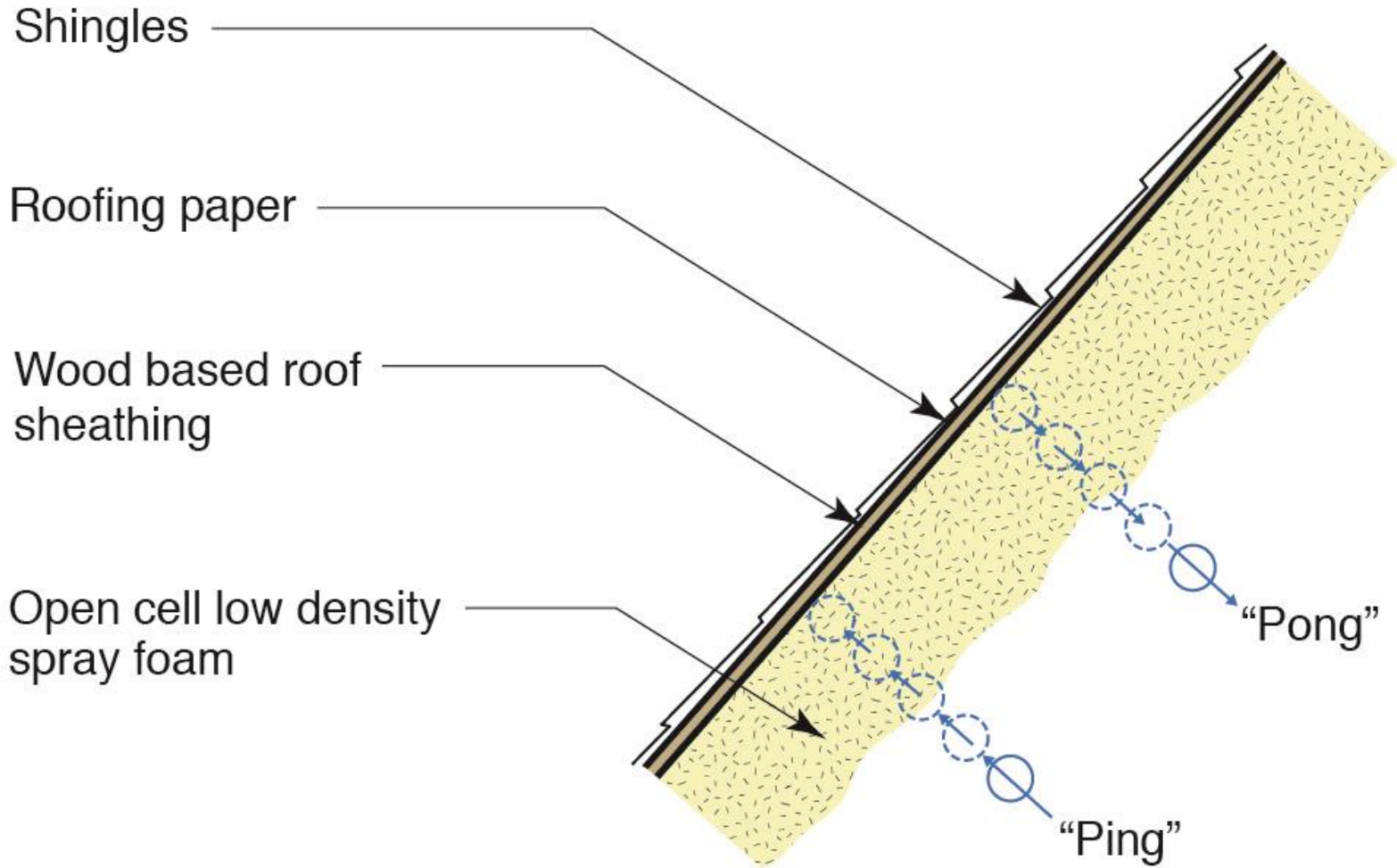

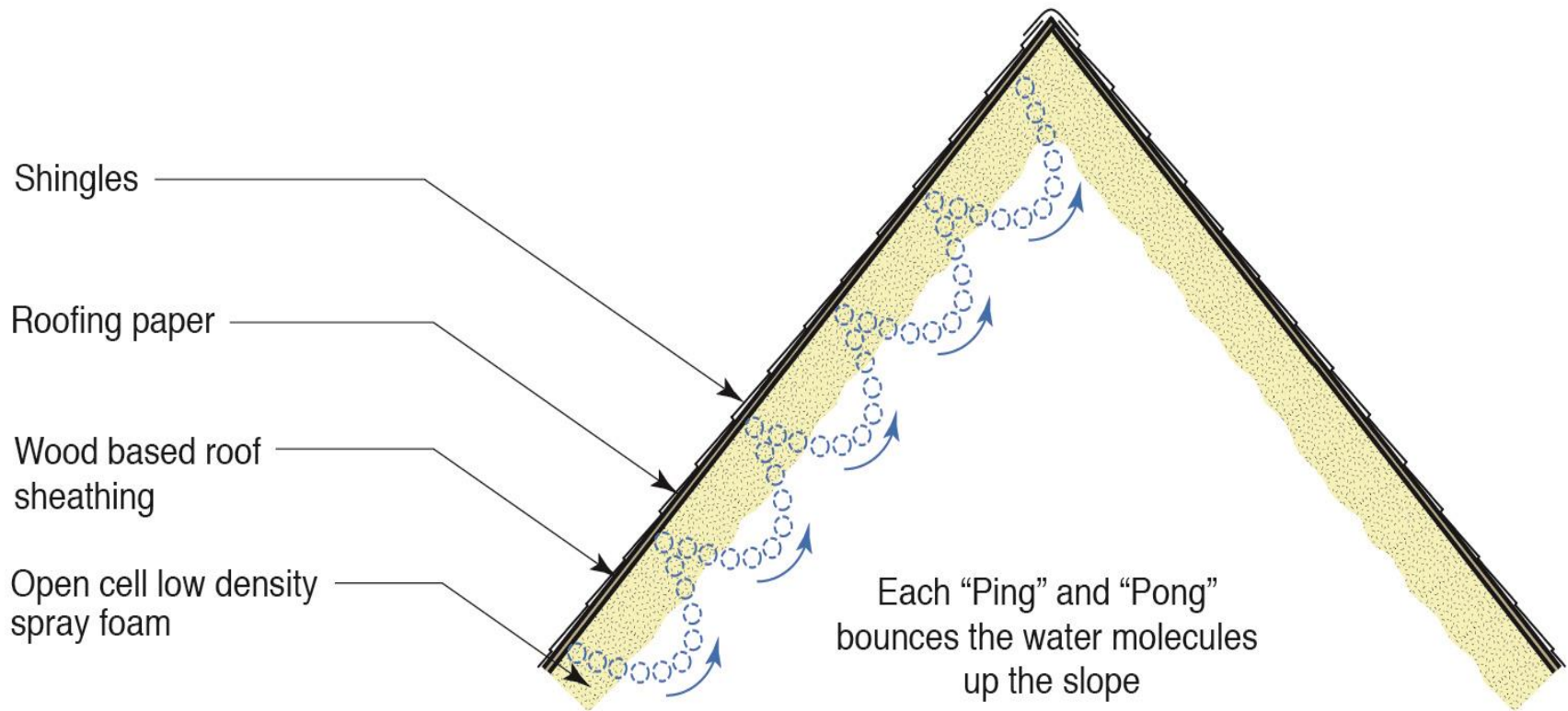

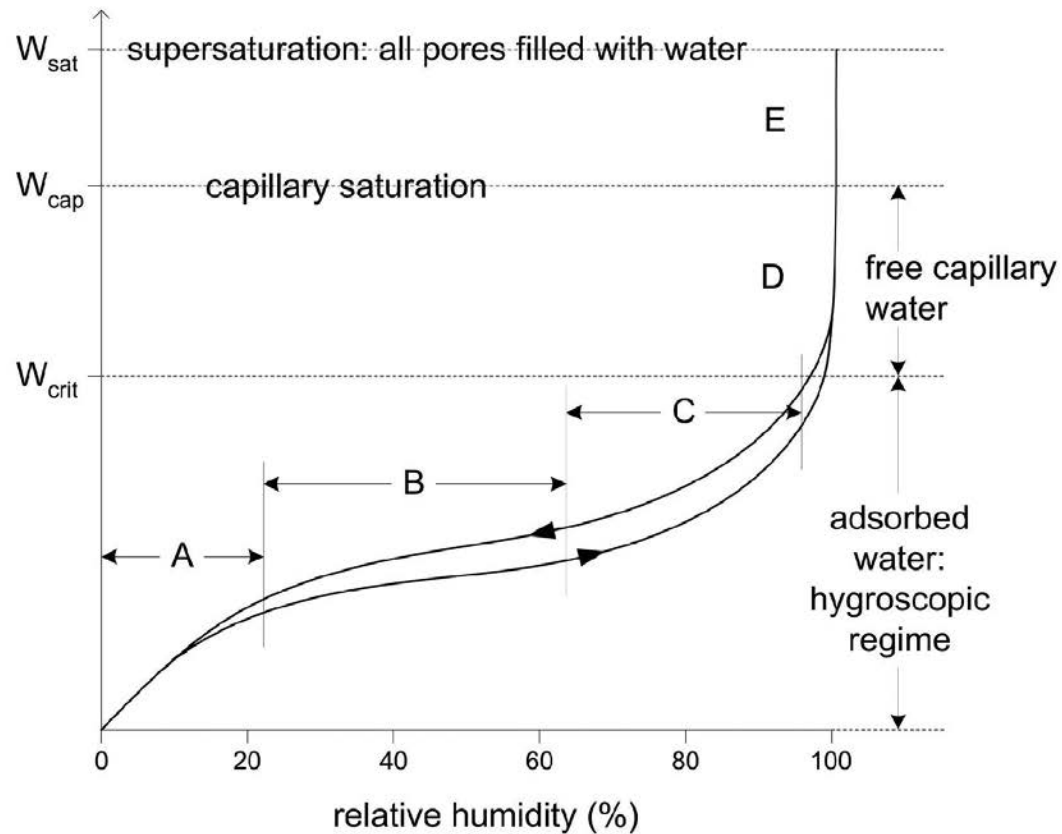

- A: Single-layer of adsorbed molecules
- B: Multiple layers of adsorbed molecules
- C: Interconnected layers (internal capillary condensation)
- D: Free water in Pores, capillary suction
- E: Supersaturated Regime

**Regimes of moisture storage in a hygroscopic porous material**

From Straube & Burnett, 2005

# SIP Failures













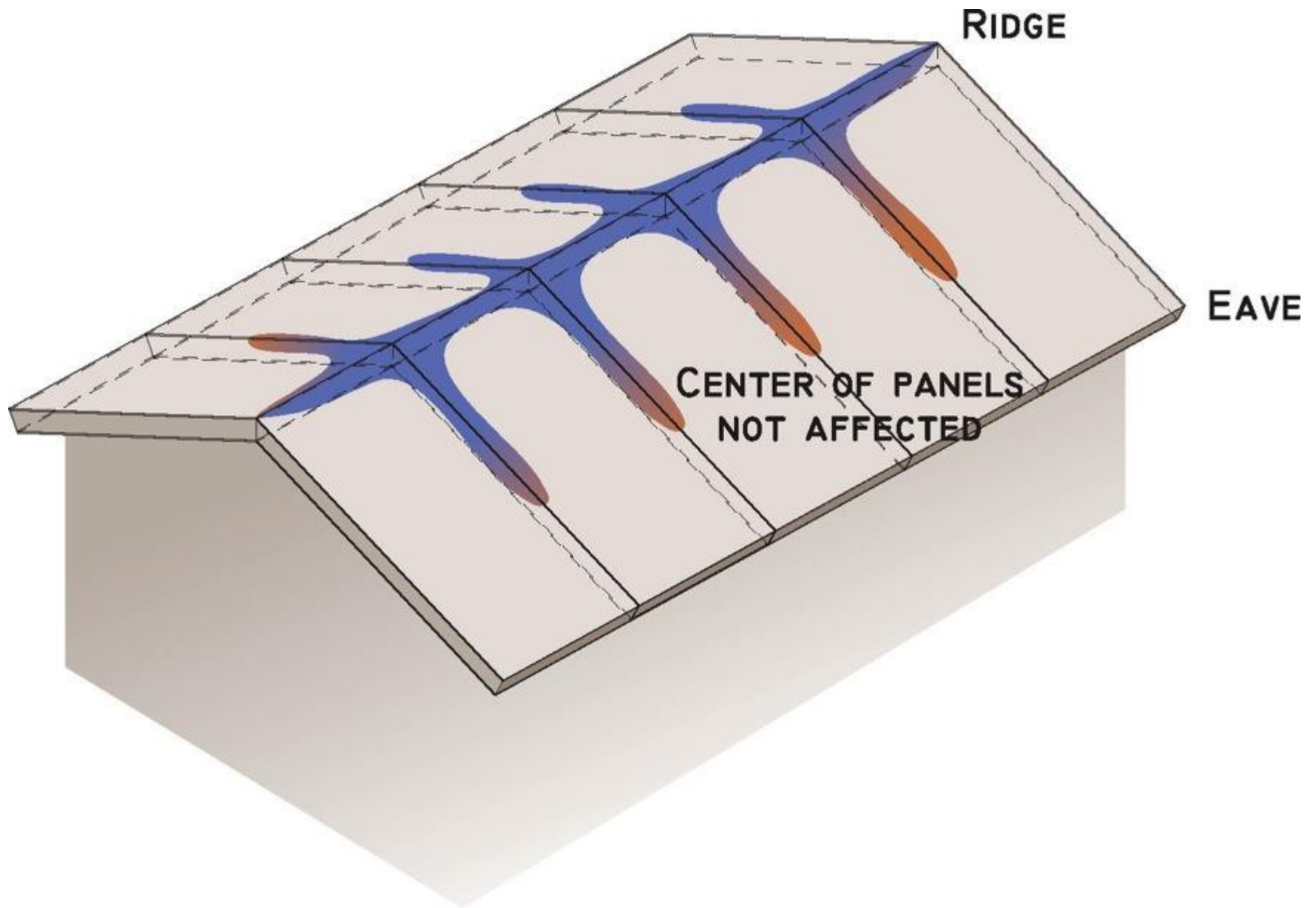









**Step 1**

- Remove strip of OSB from each side of ridge

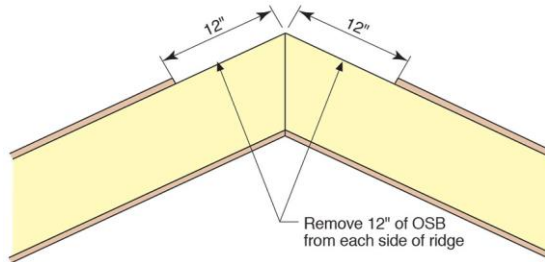

**Step 2**

- Create air seal with strip of vapor open membrane (tape seams)
- Vapor open membrane sheet sealed to OSB with acrylic caulk sealant
- Hold vapor open membrane sheet in place with metal strapping

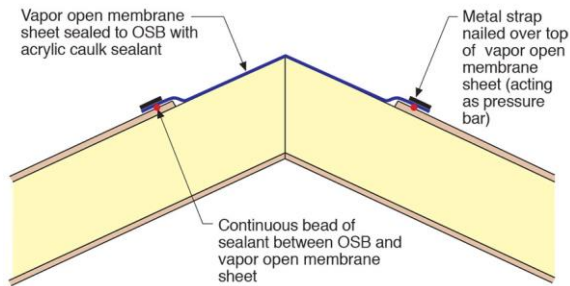

**Step 3**

- Construct wood ridge vent with 2x2 furring

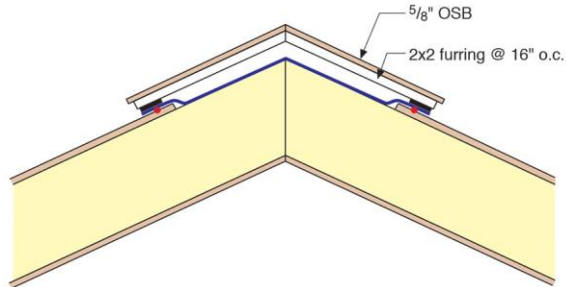



















# An Oops....That Became A Gift....









# Failures Lead To Success







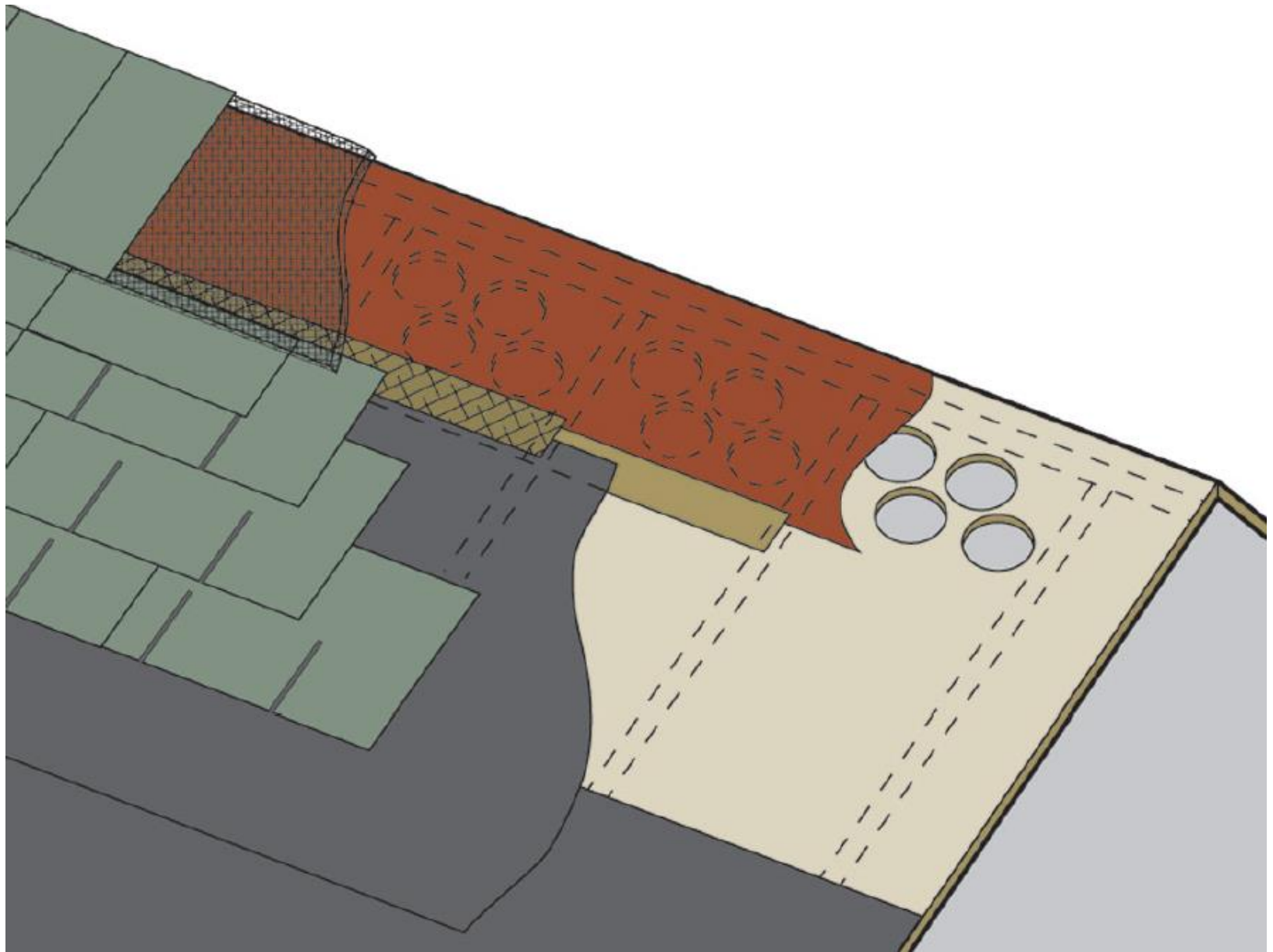



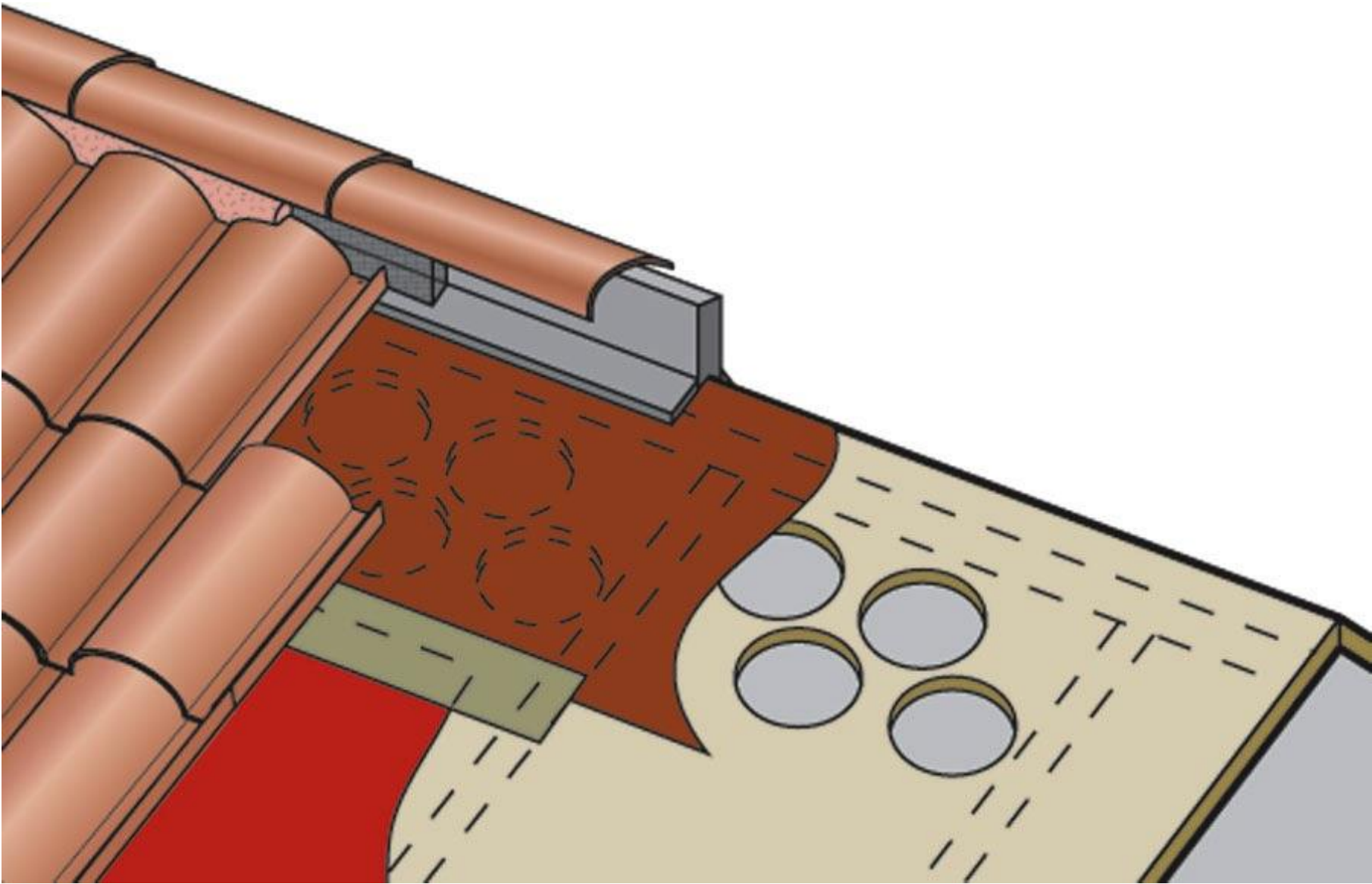

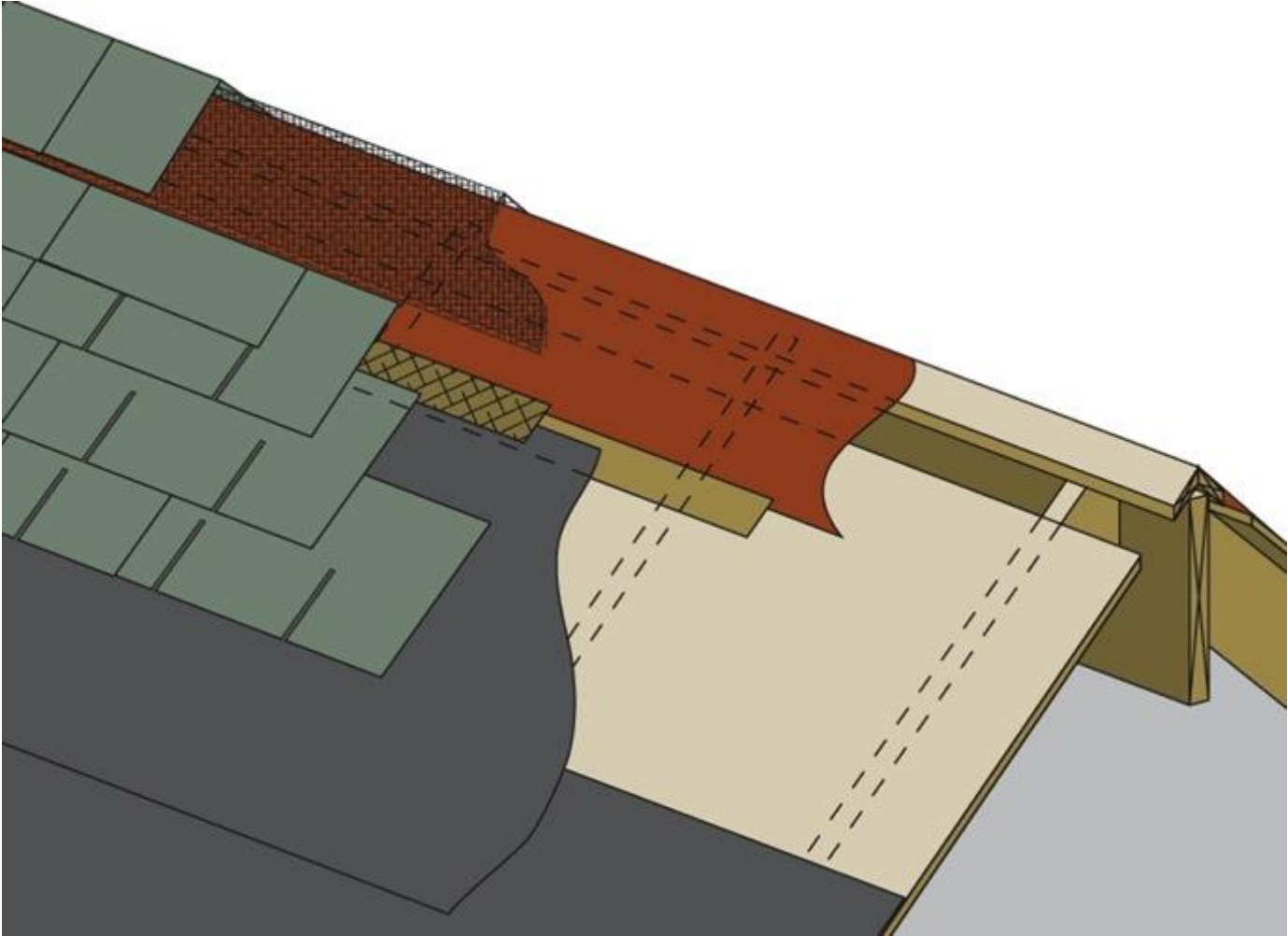

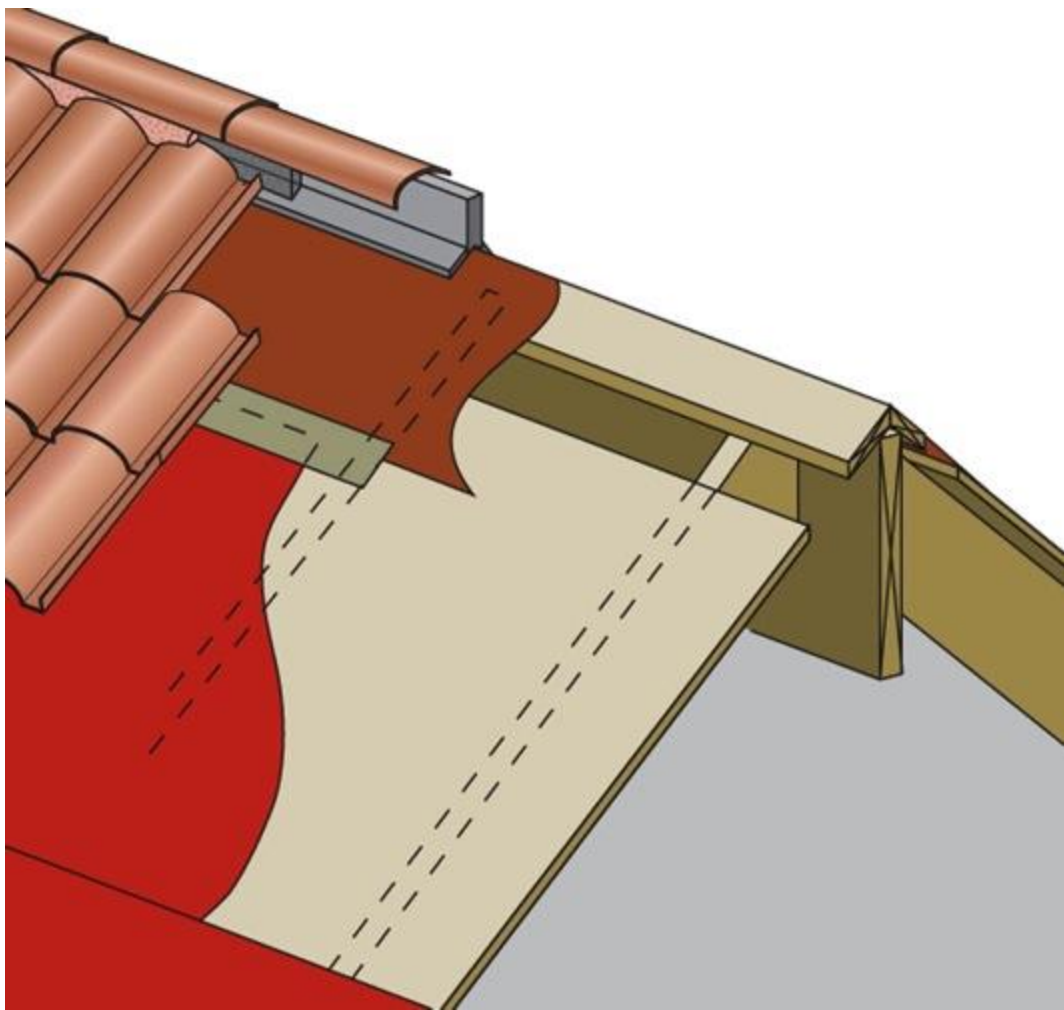





















# Hygric Buoyancy

Components in Dry Air	Volume Ratio compared to Dry Air	Molecular Mass - $M$ (kg/kmol)	Molecular Mass in Air
Oxygen	0.2095	32.00	6.704
Nitrogen	0.7809	28.02	21.88
Carbon Dioxide	0.0003	44.01	0.013
Hydrogen	0.0000005	2.02	0
Argon	0.00933	39.94	0.373
Neon	0.000018	20.18	0
Helium	0.000005	4.00	0
Krypton	0.000001	83.8	0
Xenon	$0.09 \cdot 10^{-6}$	131.29	0
Total Molecular Mass of Air			28.97

Components in Dry Air	Volume Ratio compared to Dry Air	Molecular Mass - $M$ (kg/kmol)	Molecular Mass in Air
Oxygen	0.2095	32.00	6.704
Nitrogen	0.7809	28.02	21.88
Carbon Dioxide	0.0003	44.01	0.013
Hydrogen	0.0000005	2.02	0
Argon	0.00933	39.94	0.373
Neon	0.000018	20.18	0
Helium	0.000005	4.00	0
Krypton	0.000001	83.8	0
Xenon	$0.09 \cdot 10^{-6}$	131.29	0
Total Molecular Mass of Air			28.97

Note Water Vapor (H<sub>2</sub>O) is 18  
 Dry Air is 29

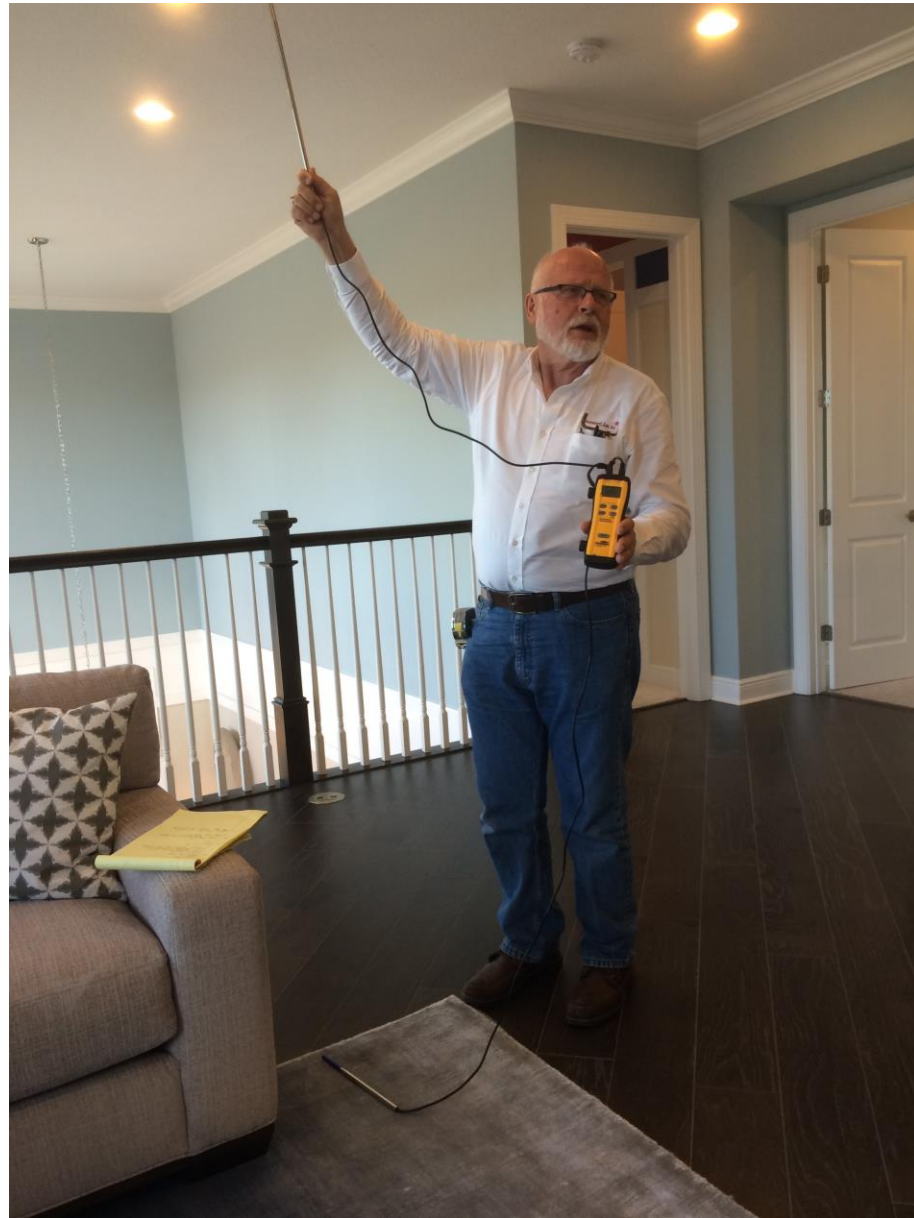





# Ratios

1:150

1:300

1:600

Conditioned Attics Not Unvented Attics  
Need Supply Air  
50 cfm/1000 ft<sup>2</sup> of Attic

Or  
Dehumidification

# Burying Ducts

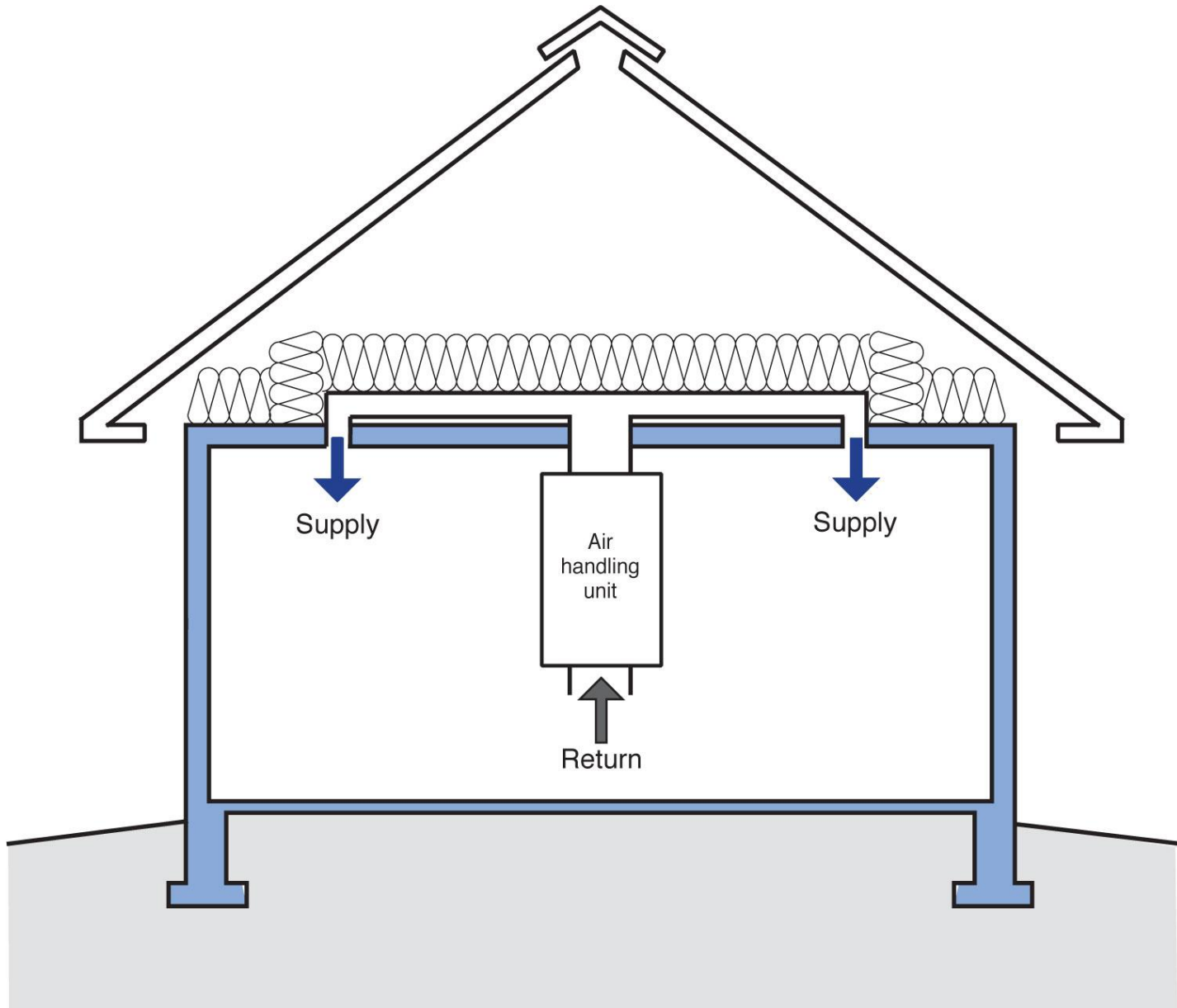

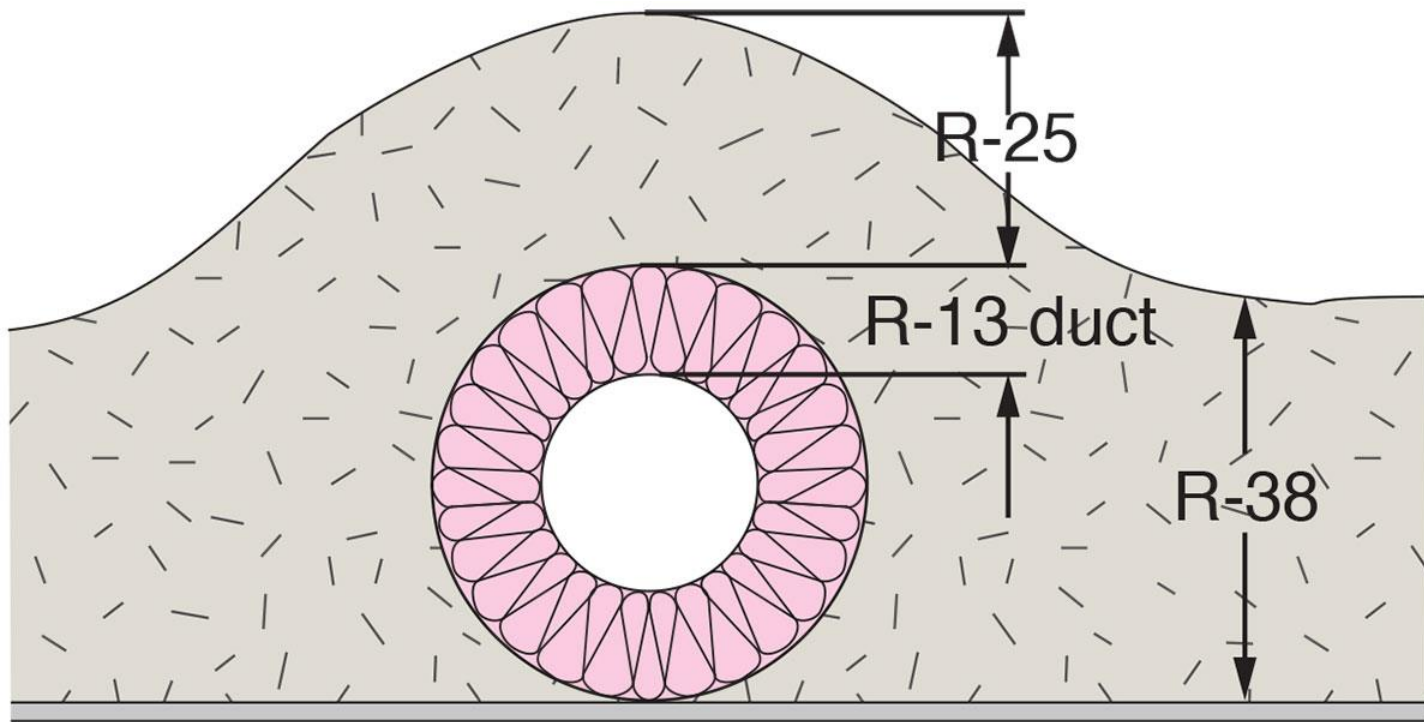



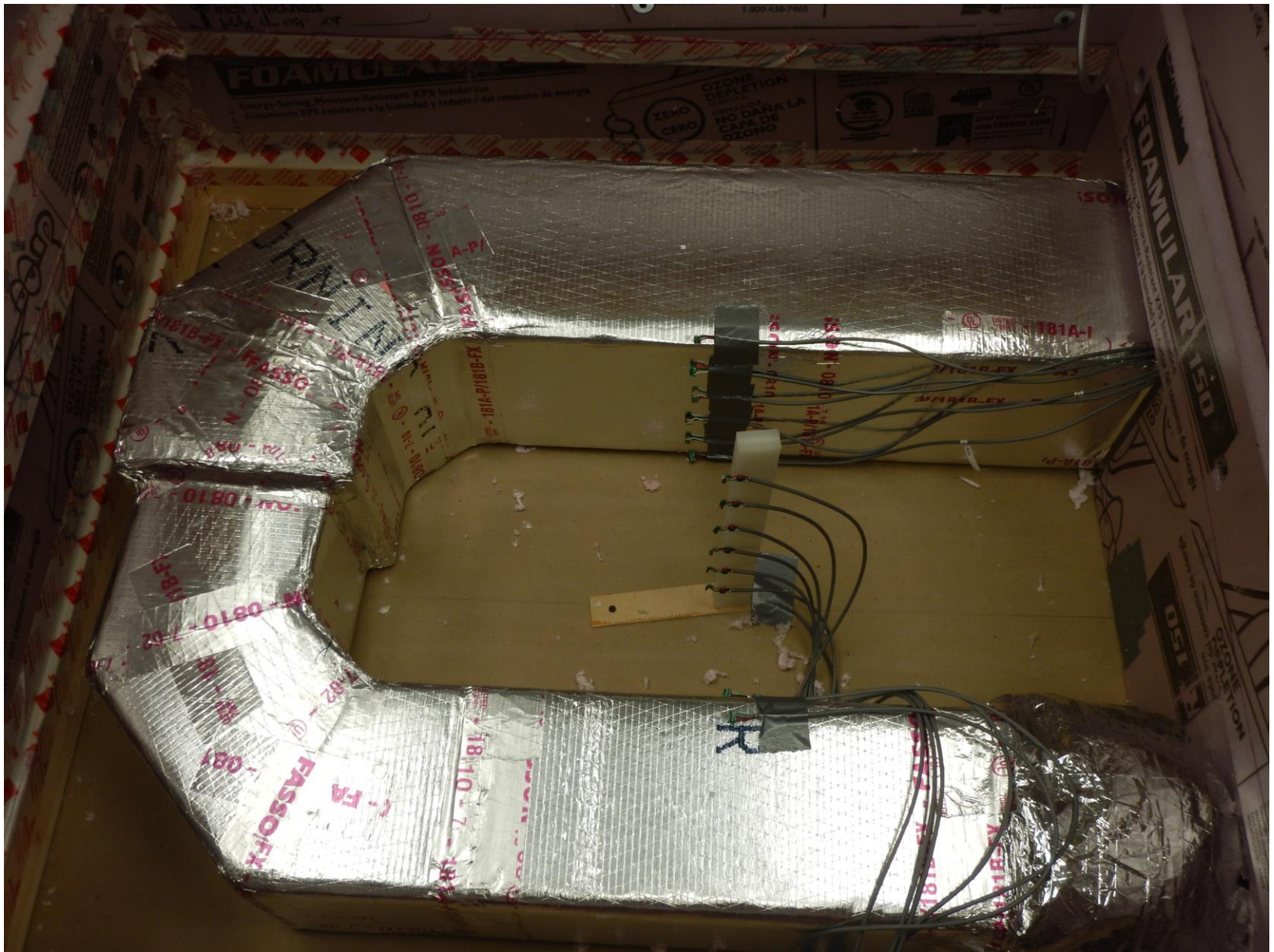





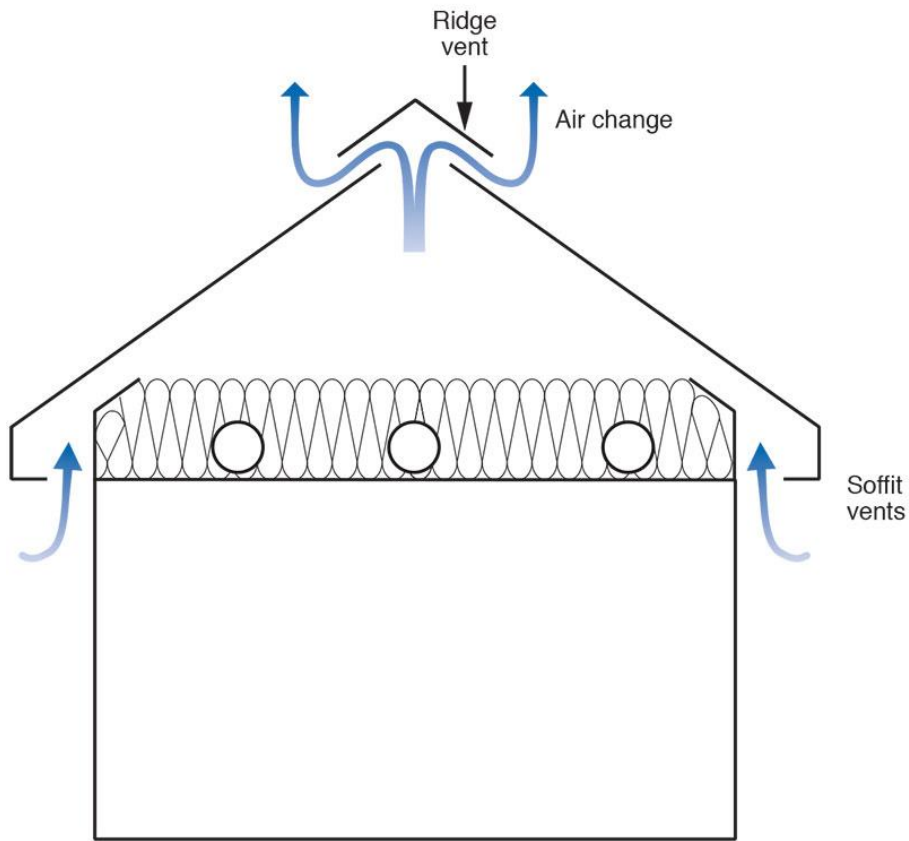

Classic vented attic

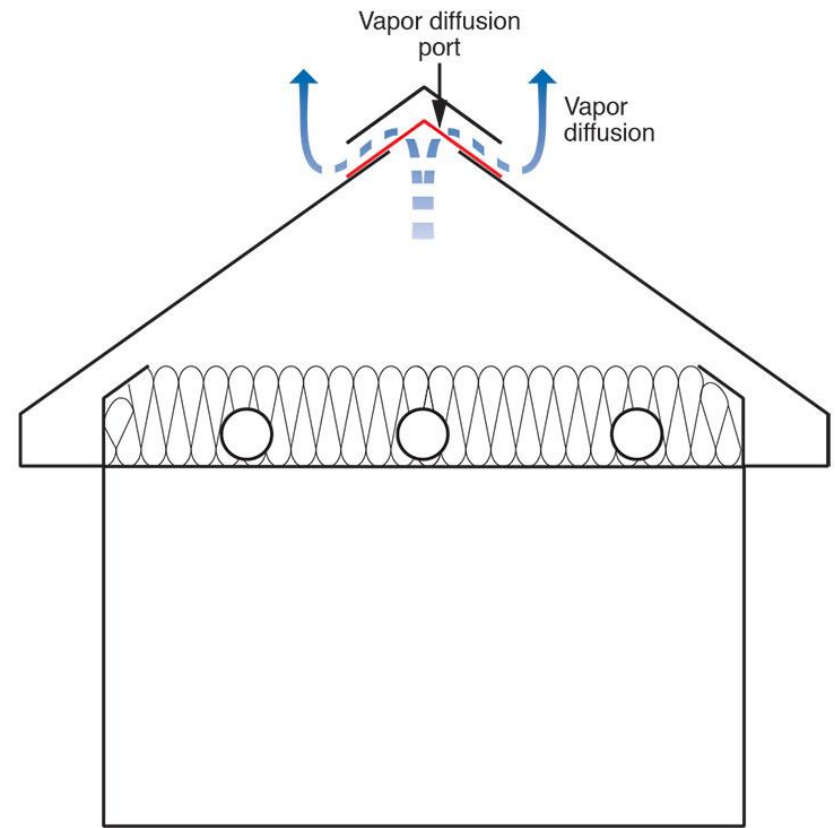

Unvented attic with vapor diffusion port

# Vancouver Mold

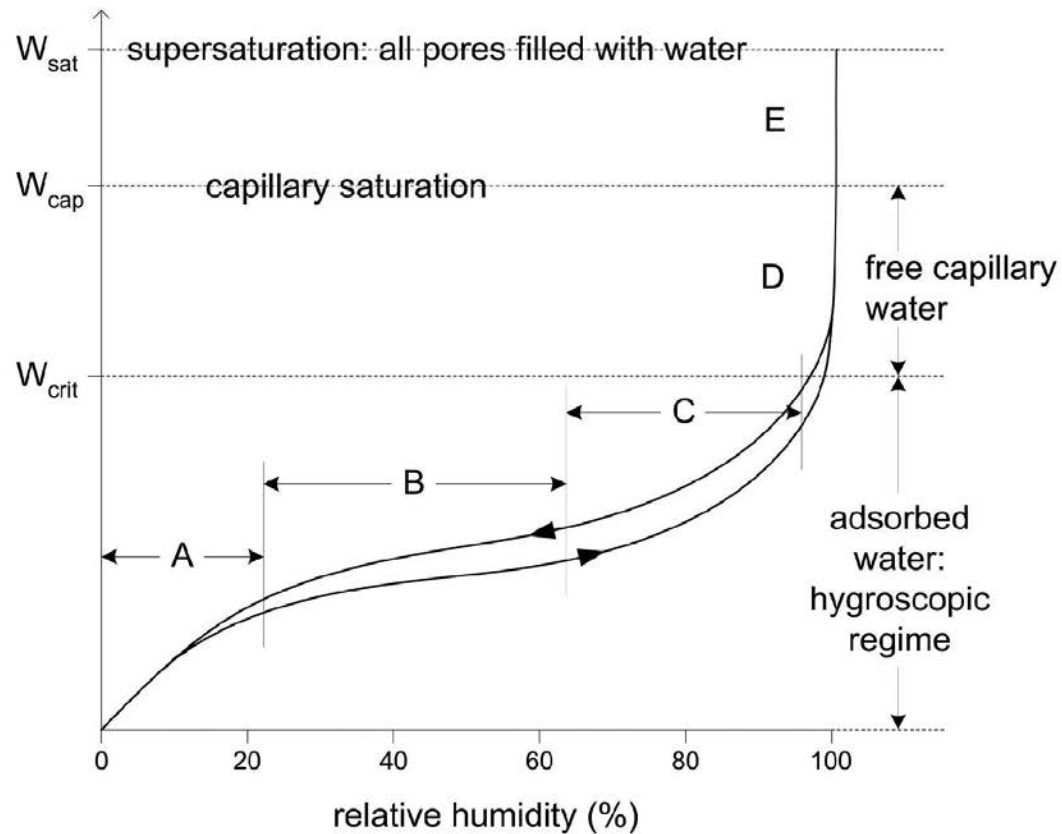

- A: Single-layer of adsorbed molecules
- B: Multiple layers of adsorbed molecules
- C: Interconnected layers (internal capillary condensation)
- D: Free water in Pores, capillary suction
- E: Supersaturated Regime

**Regimes of moisture storage in a hygroscopic porous material**

From Straube & Burnett, 2005

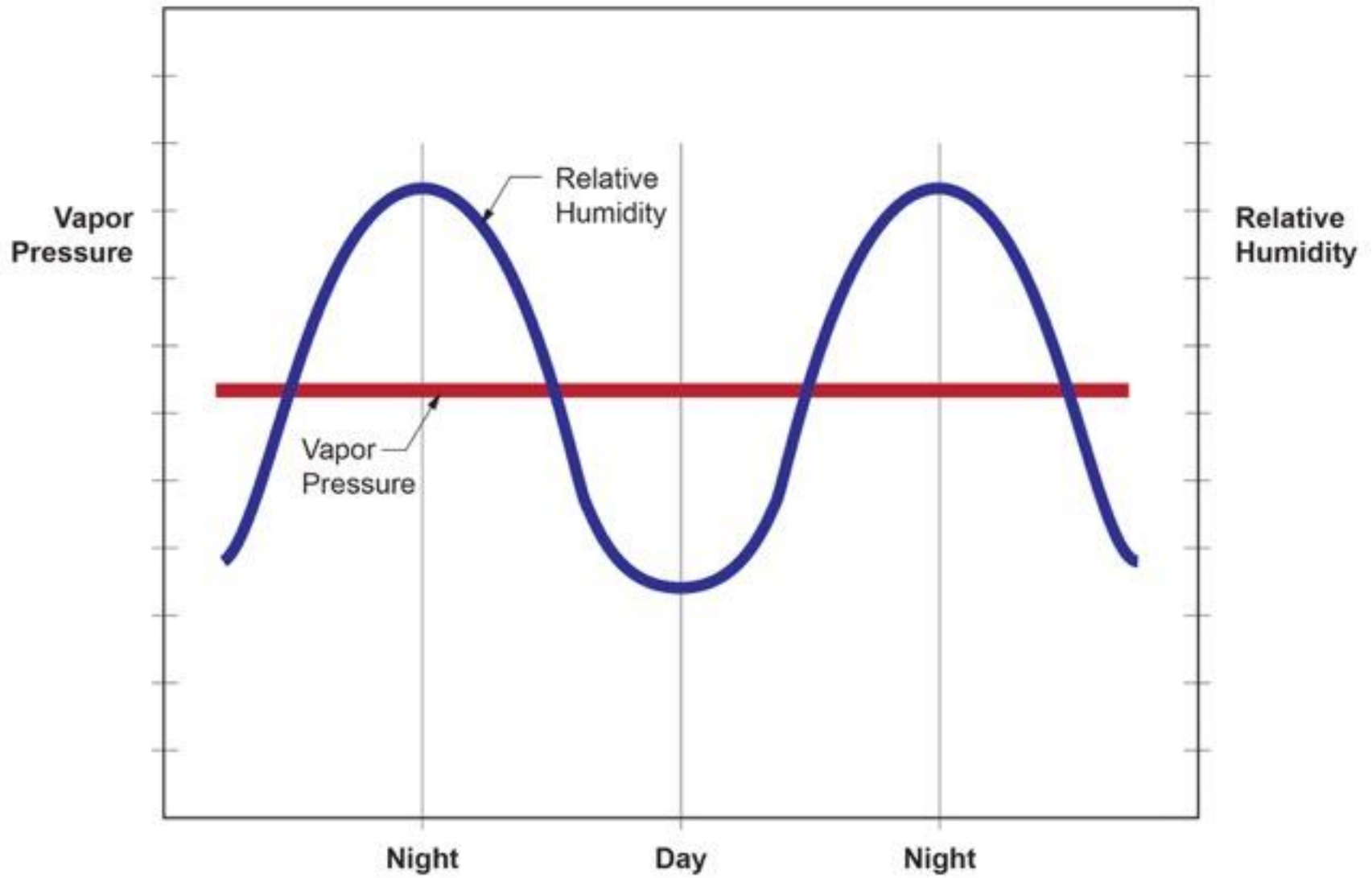

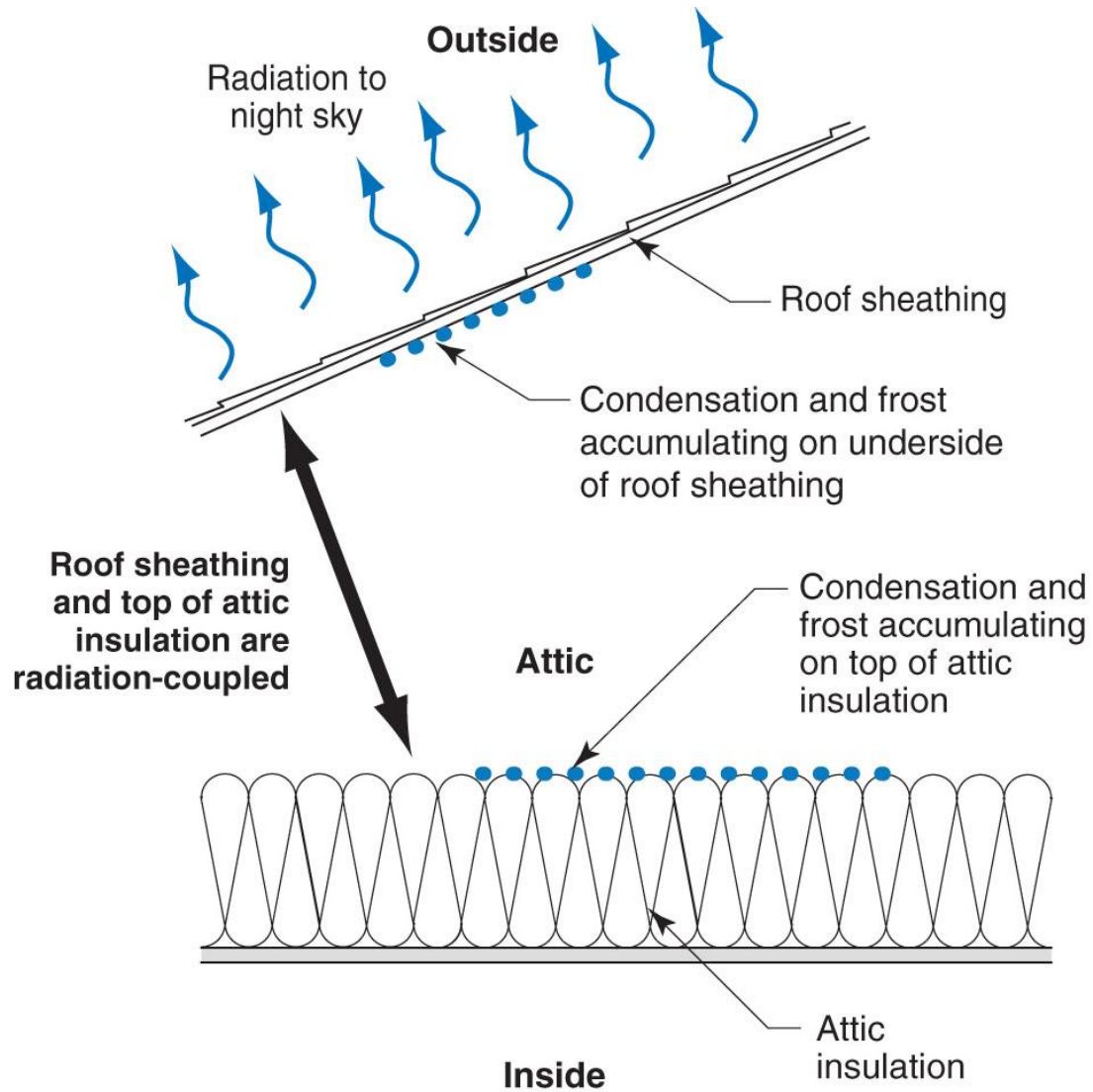

















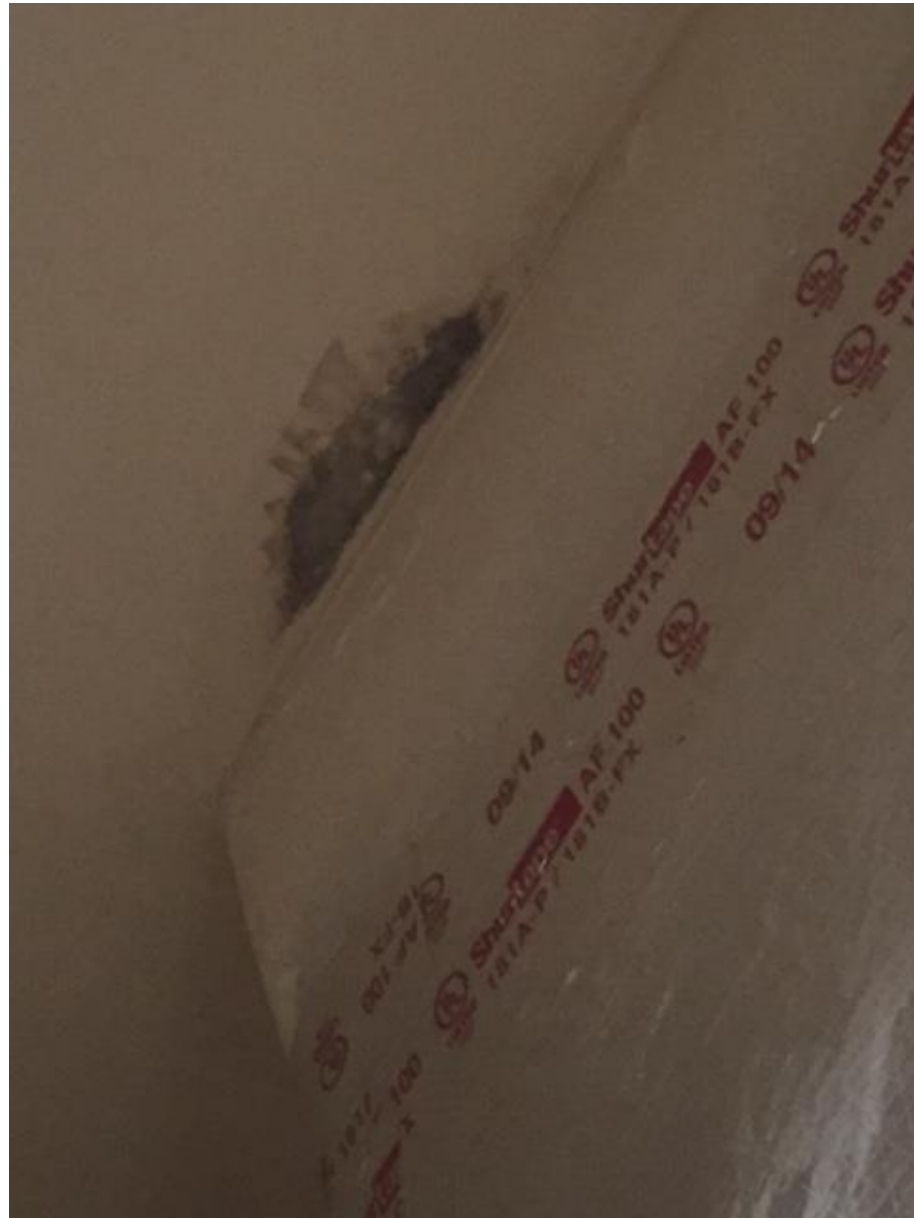















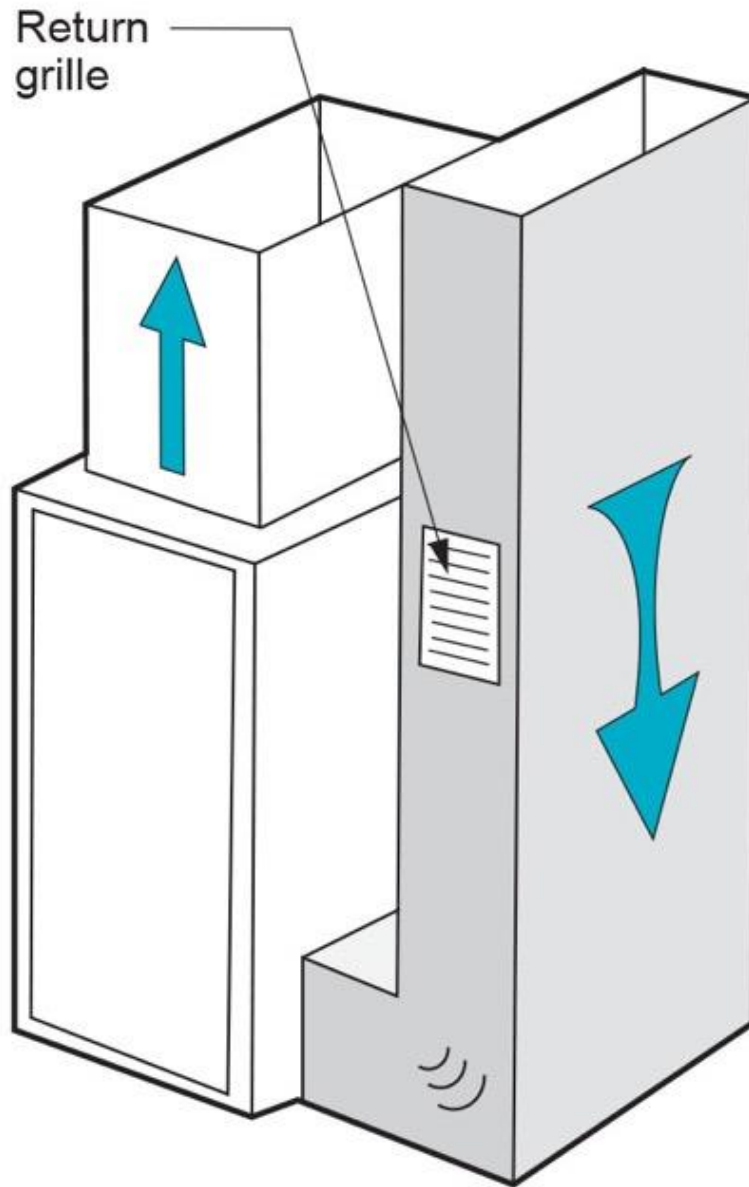

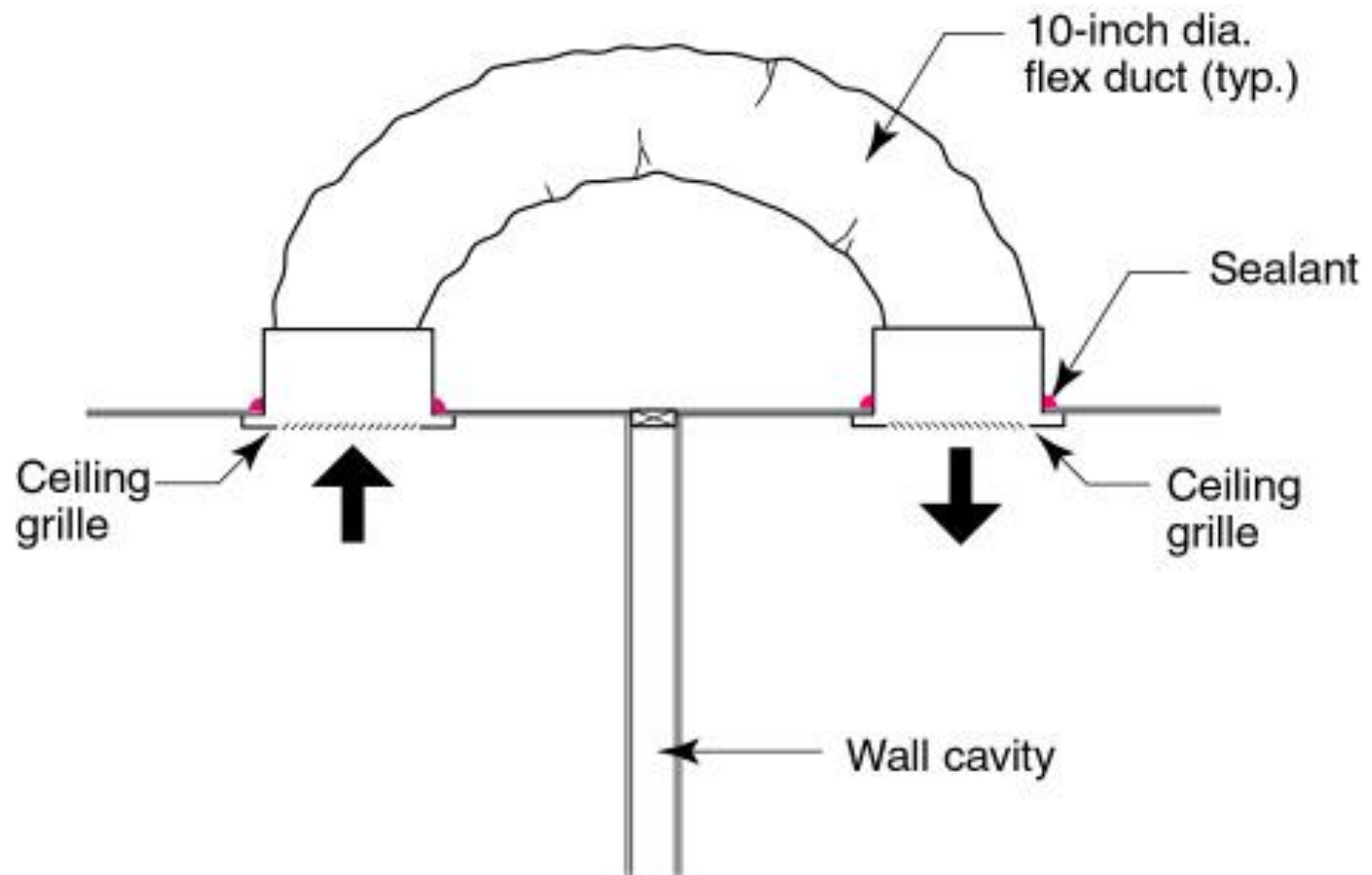

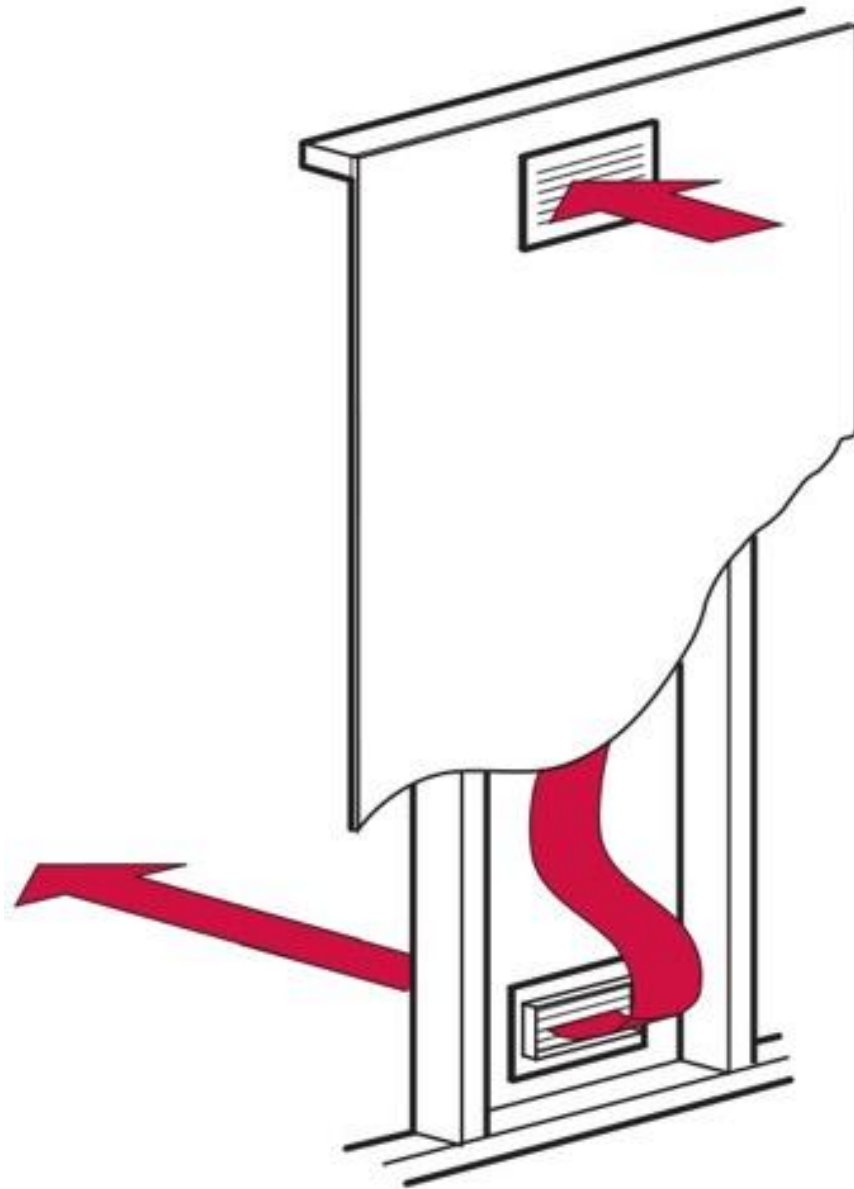

Cavity is sealed tight,  
drywall glued to studs and  
plates on both sides





