

Joseph Lstiburek, Ph.D., P.Eng, ASHRAE Fellow

# Building Science

---

Adventures In Building Science

presented by [www.buildingscience.com](http://www.buildingscience.com)

# Definition of a Problem

People

Pollutant (hot, wet, UV, ozone)

Path

Pressure











Supply air into occupied zone returns to AHU by passing through deliberately porous dropped ceiling or through return grilles installed in dropped ceiling

Air handling unit extracts air from dropped ceiling, conditions it and injects it into the occupied zones via supply ductwork

Dropped ceiling depressurized by air handling units extracting air from dropped ceiling

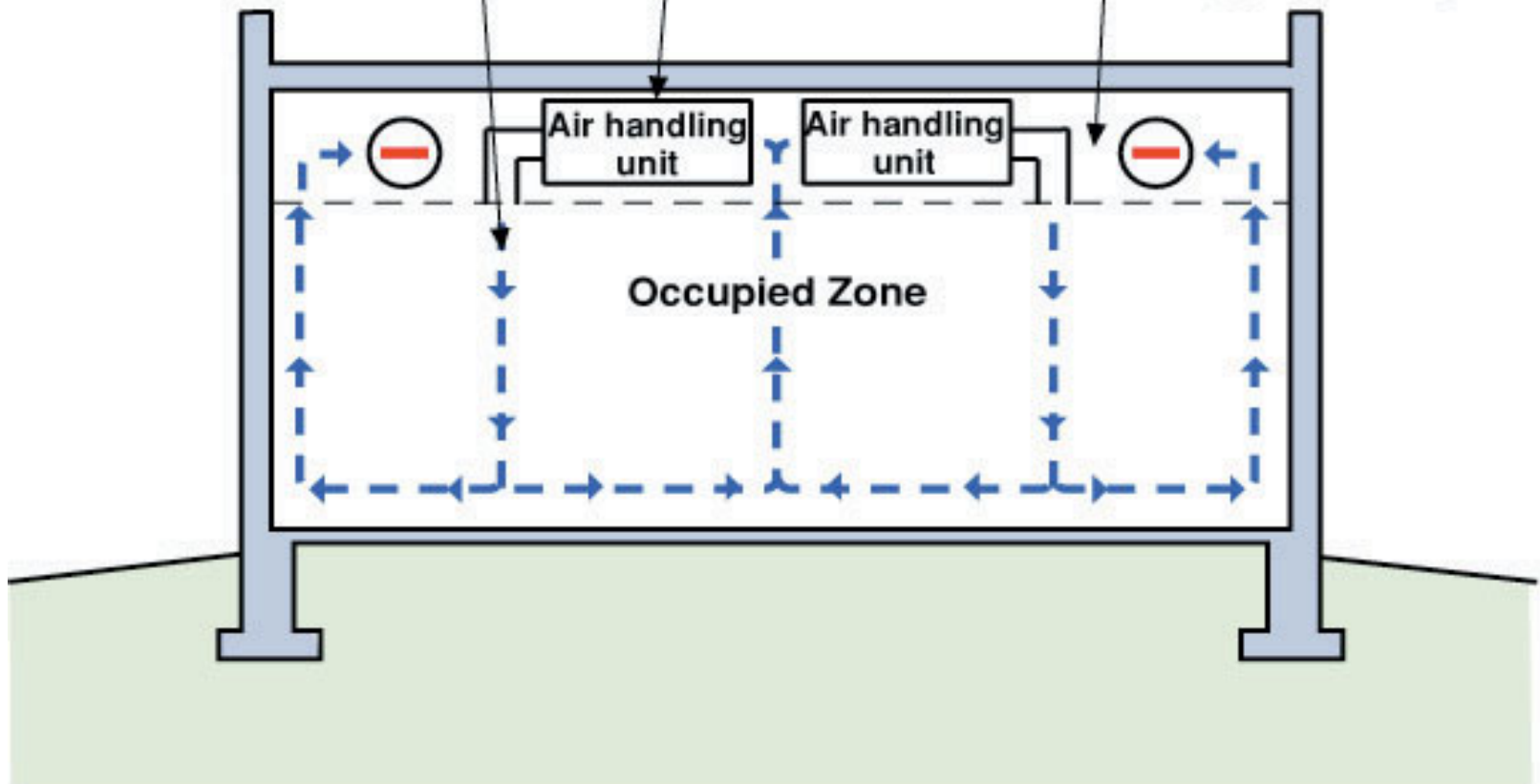



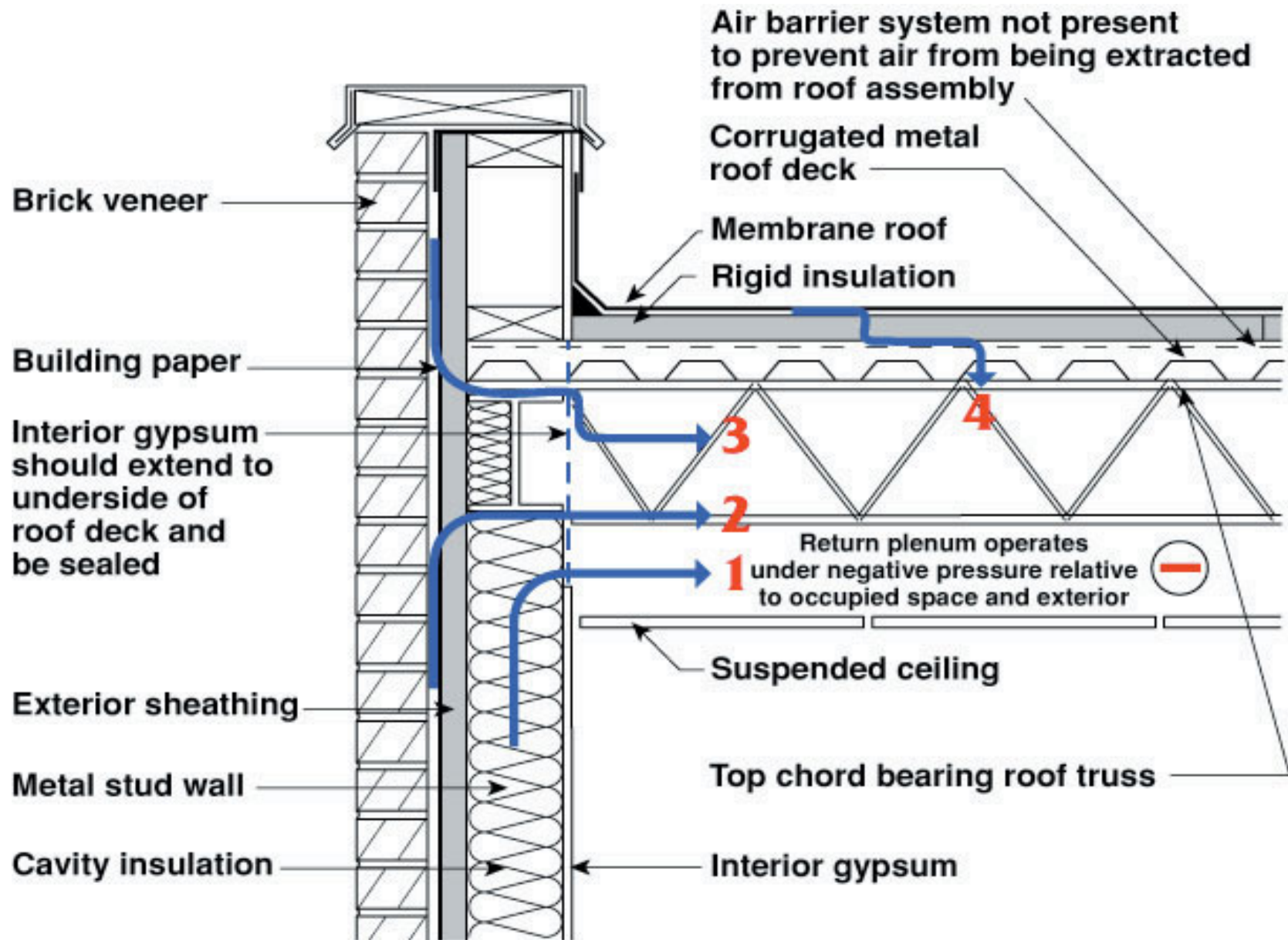

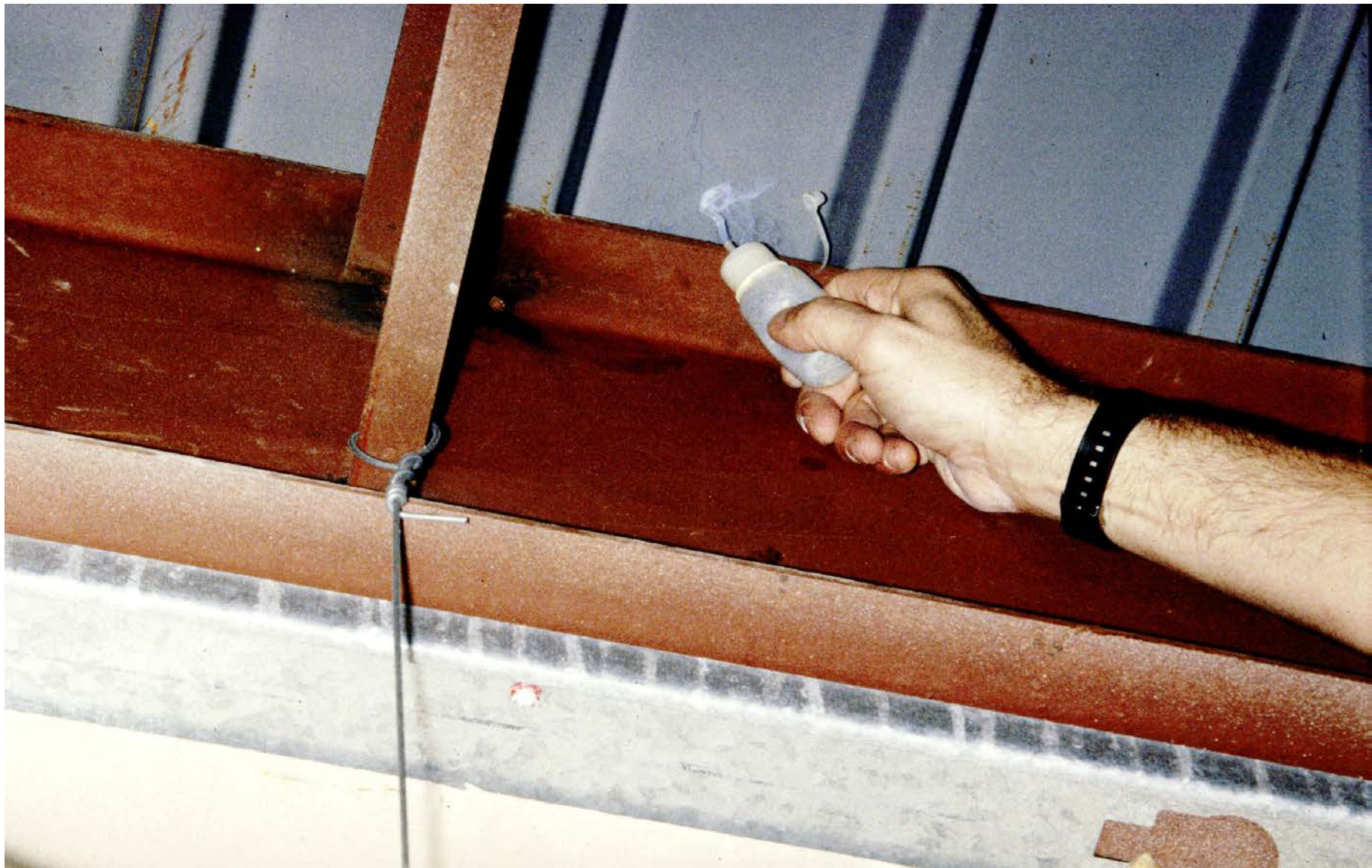

















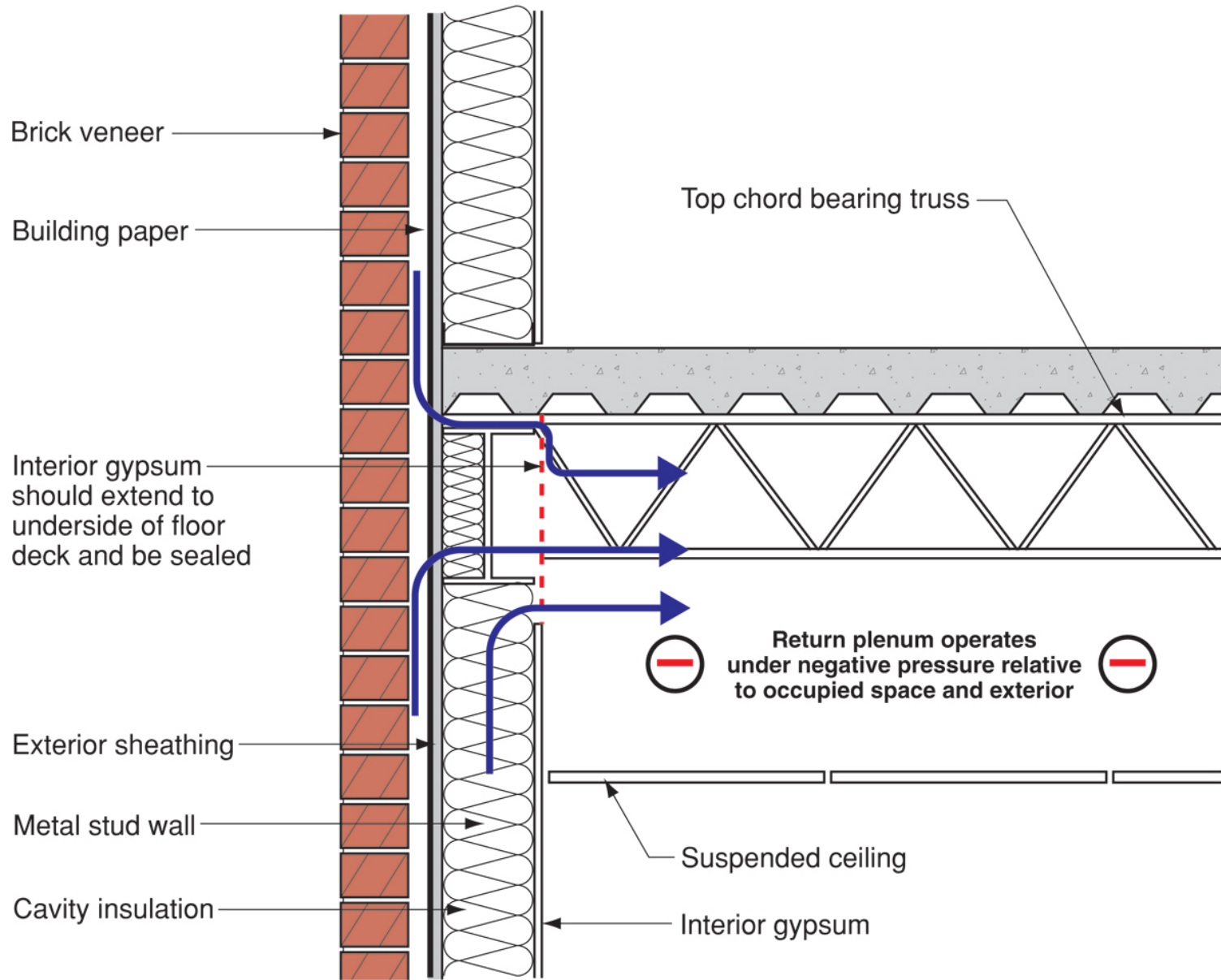

















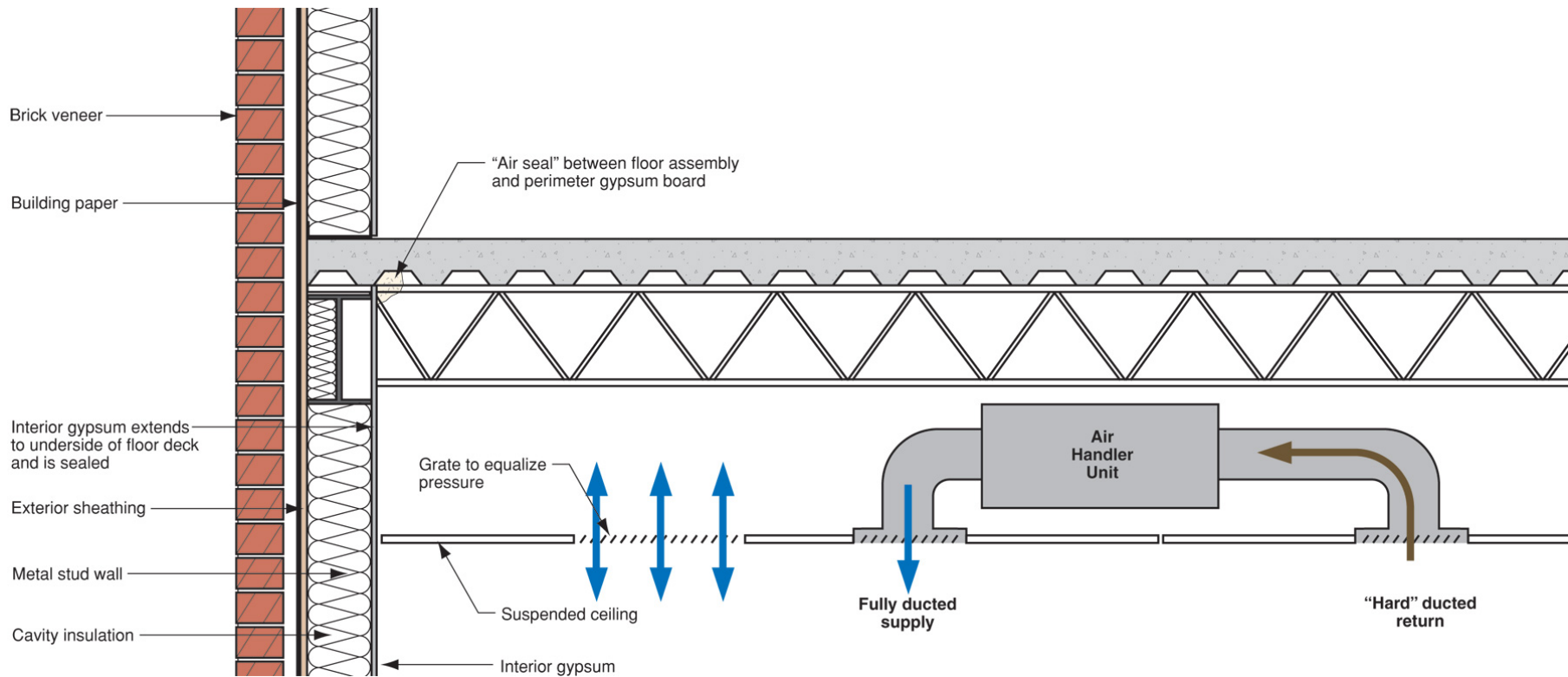

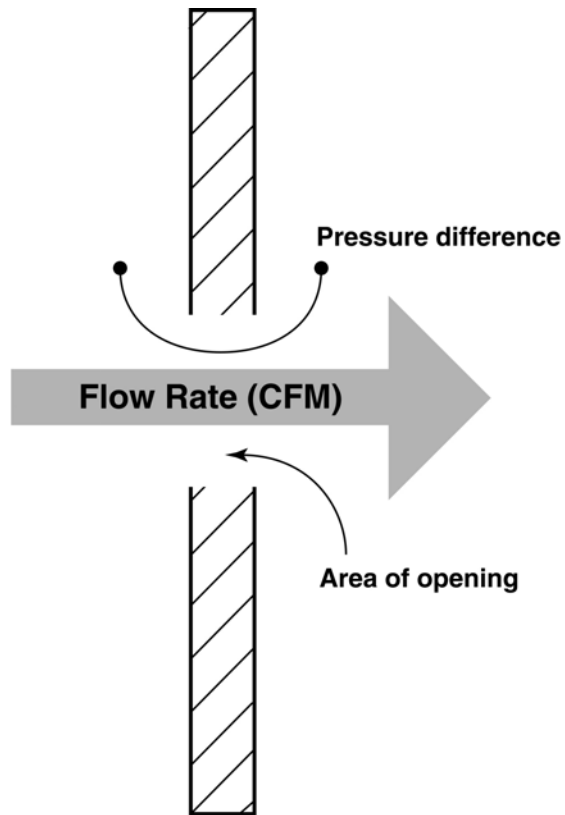

---

### Air Flow

- Air flow depends on size of hole
  - Air flow depends on pressure difference
  - Air flows from higher pressure to lower pressure
- $\text{Flow} \cong \text{Area} \times \sqrt{\Delta P} \times \text{Coefficient}$

Figure 2.11  
**Three Dimensional Multi-Layer  
Multi-Cell Analogue**

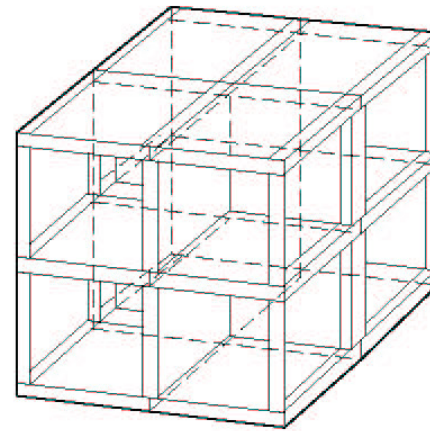

Figure 2.12  
**Three Dimensional Multi-Layer  
Multi-Cell Non-Contiguous  
Analogue**

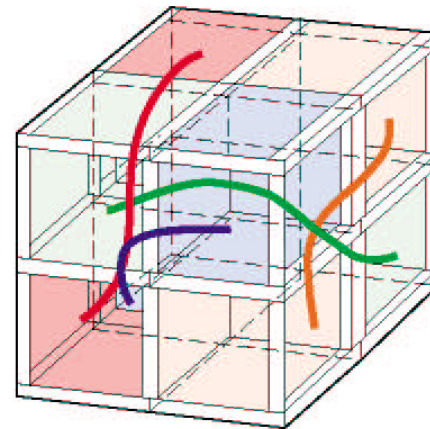
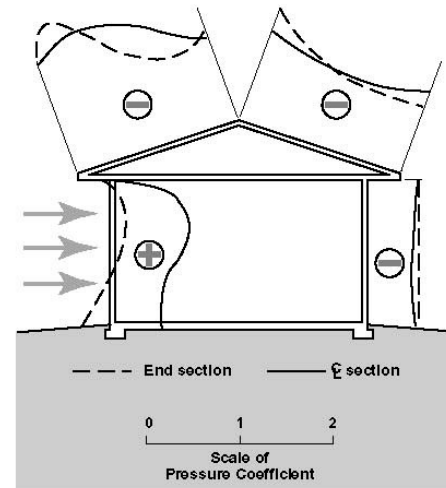
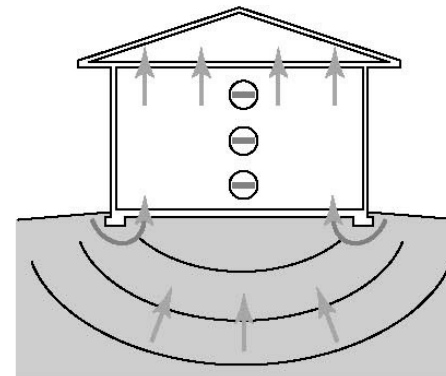

Figure 3.1  
**Exterior Air Pressure Field**  
(from Hutcheon & Handegord, 1983)



Distribution of pressures (+) and  
suctions (-) on a house with a  
low-sloped roof with wind  
perpendicular to eave

Figure 3.2  
**Exterior Air Pressure Field  
Extending Below Grade**



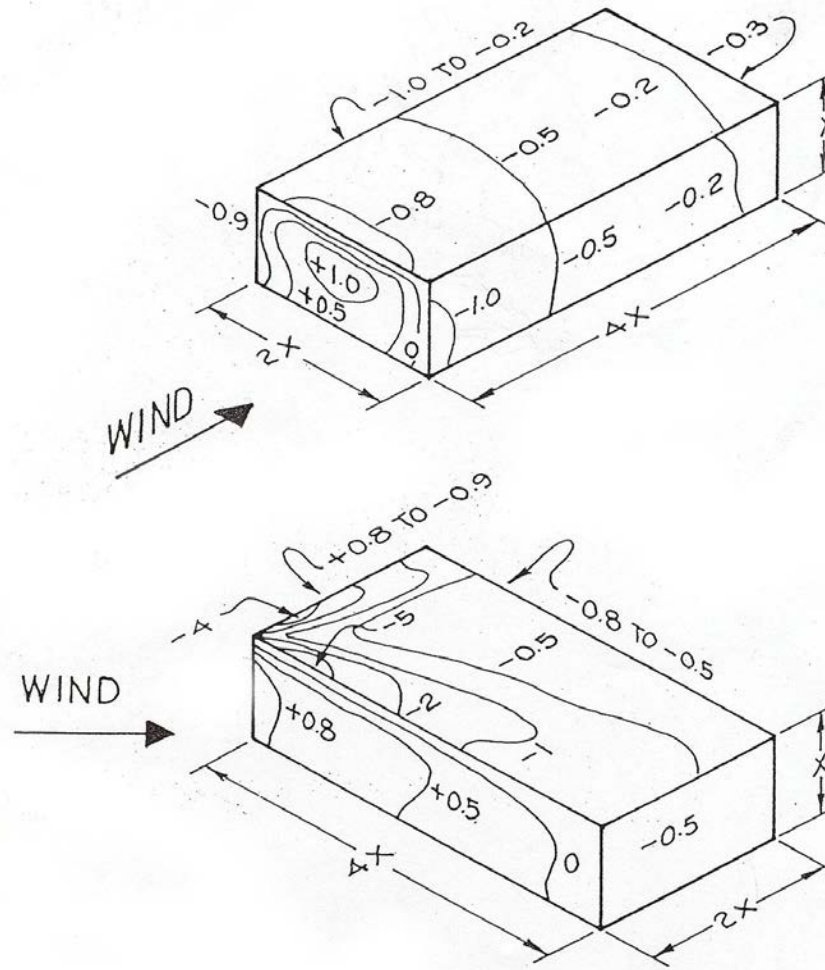

Pressure coefficients on walls and roof of rectangular buildings without parapets.

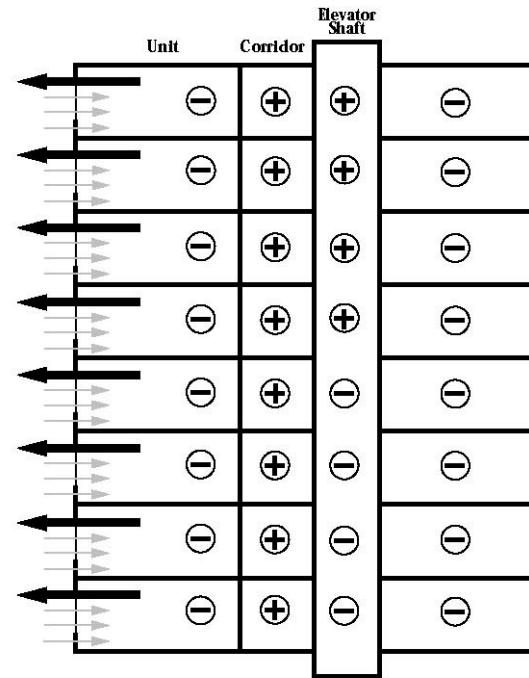

Figure 3.3  
**Interior Air Pressure Field**

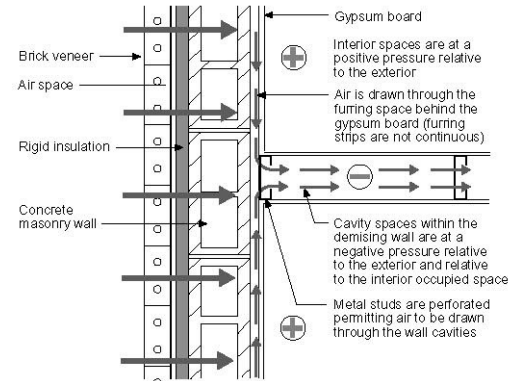

Figure 3.4  
**Interstitial Air Pressure Field**

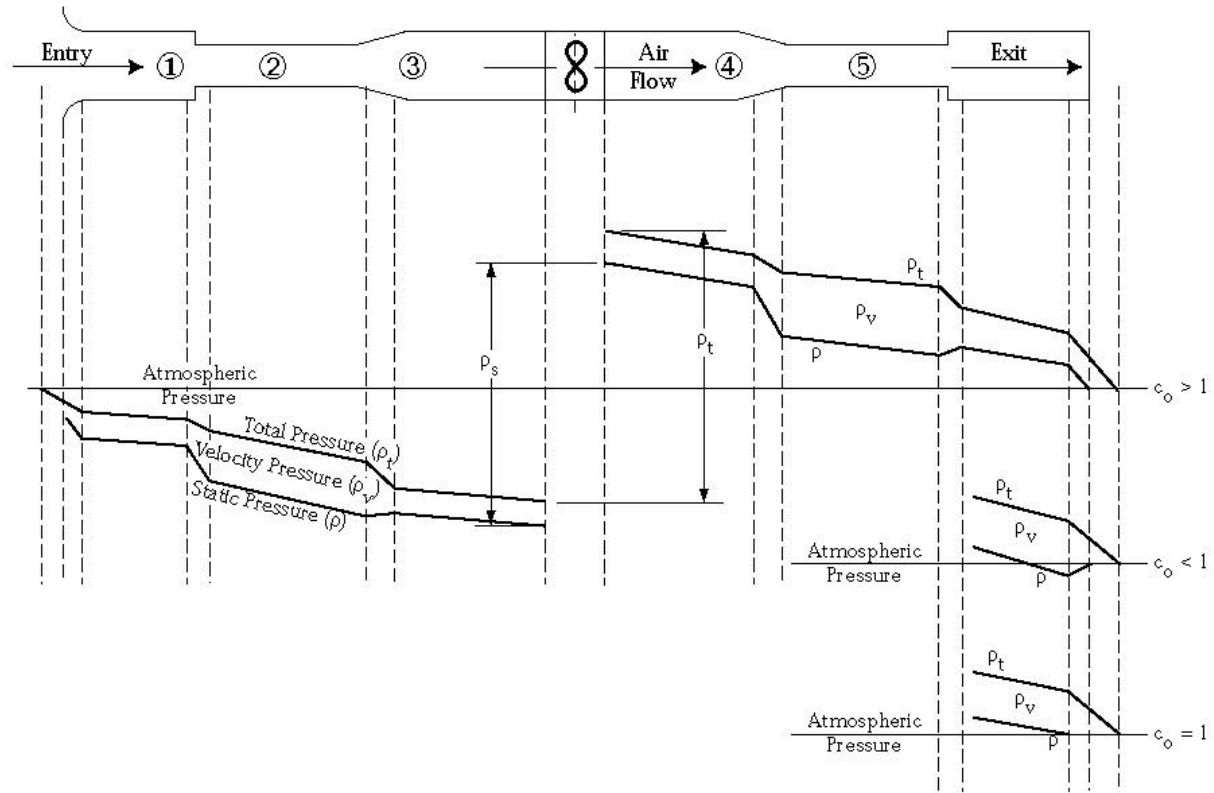

Figure 3.5  
**Air Conveyance System Air Pressure Field**  
 (from Sauer & Howell, 1990)





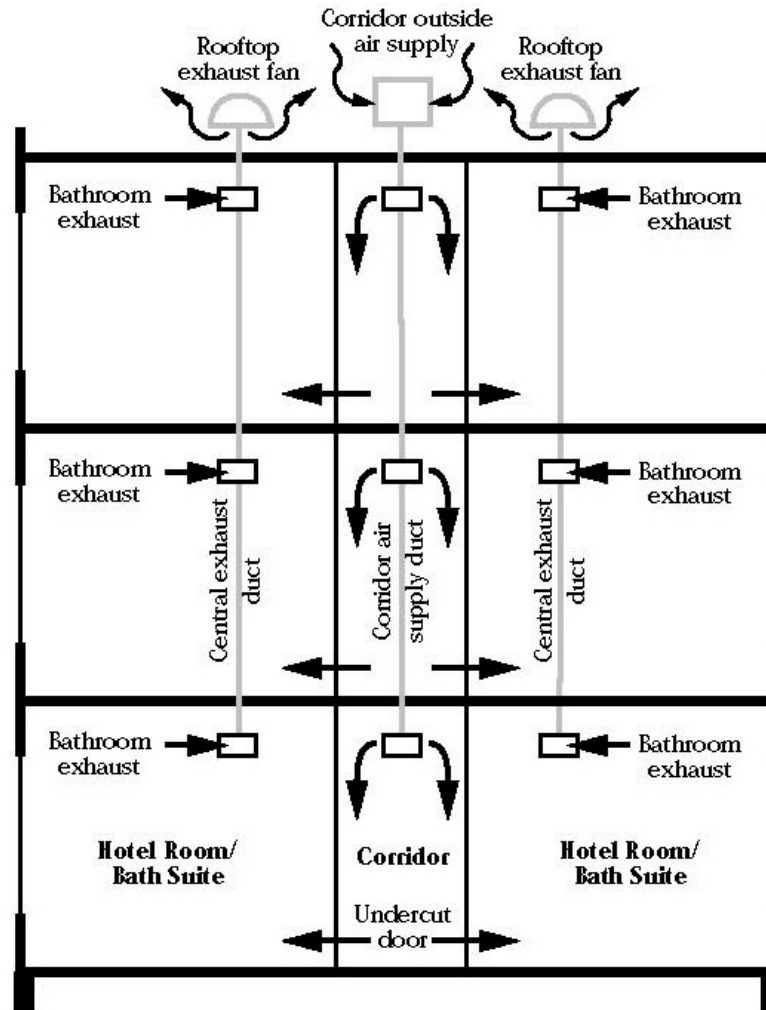

Figure 3.8

**Hotel HVAC System**

- Air exhausted from bathrooms via central rooftop exhaust fans
- Air supplied from corridors via undercut doors





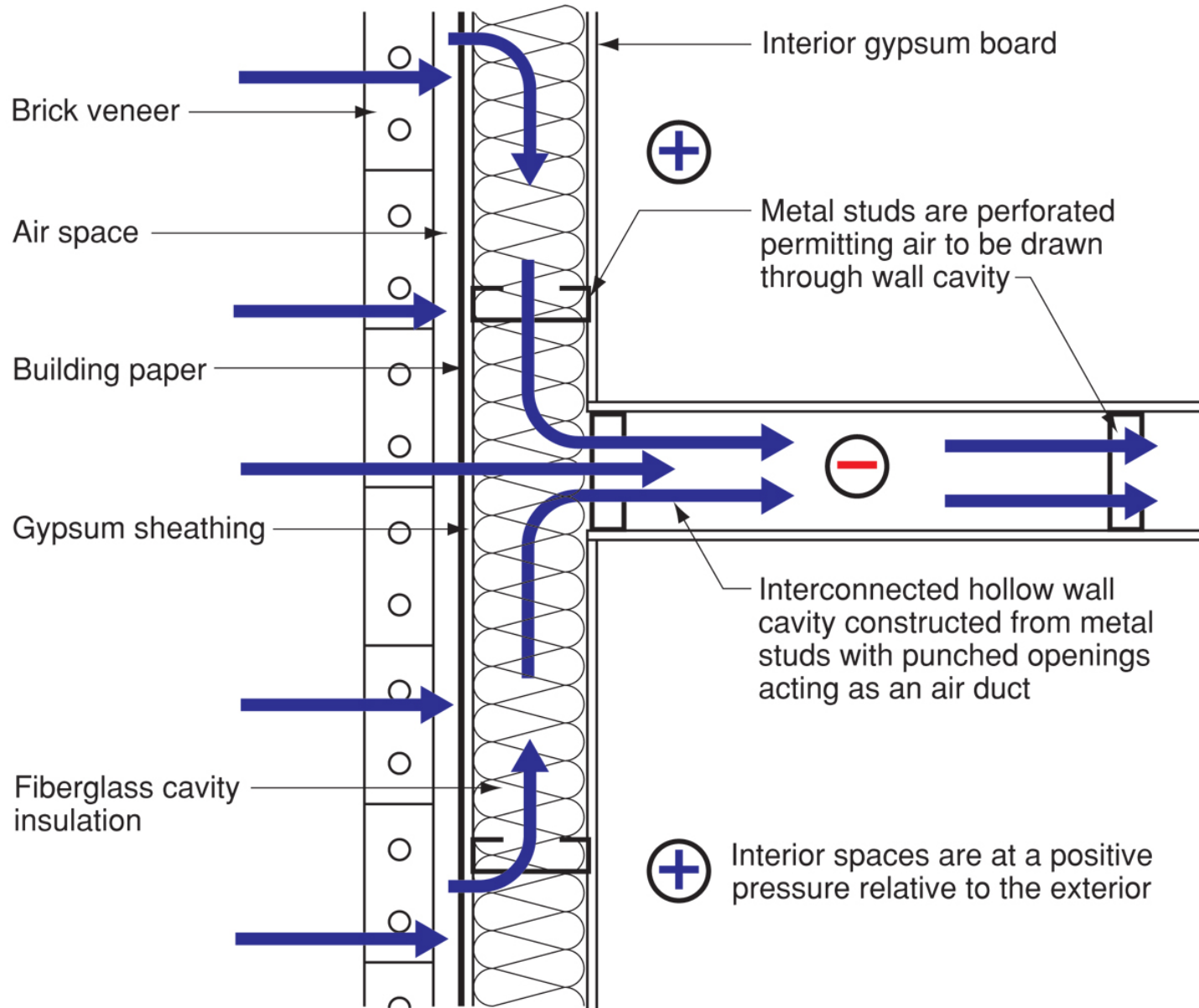

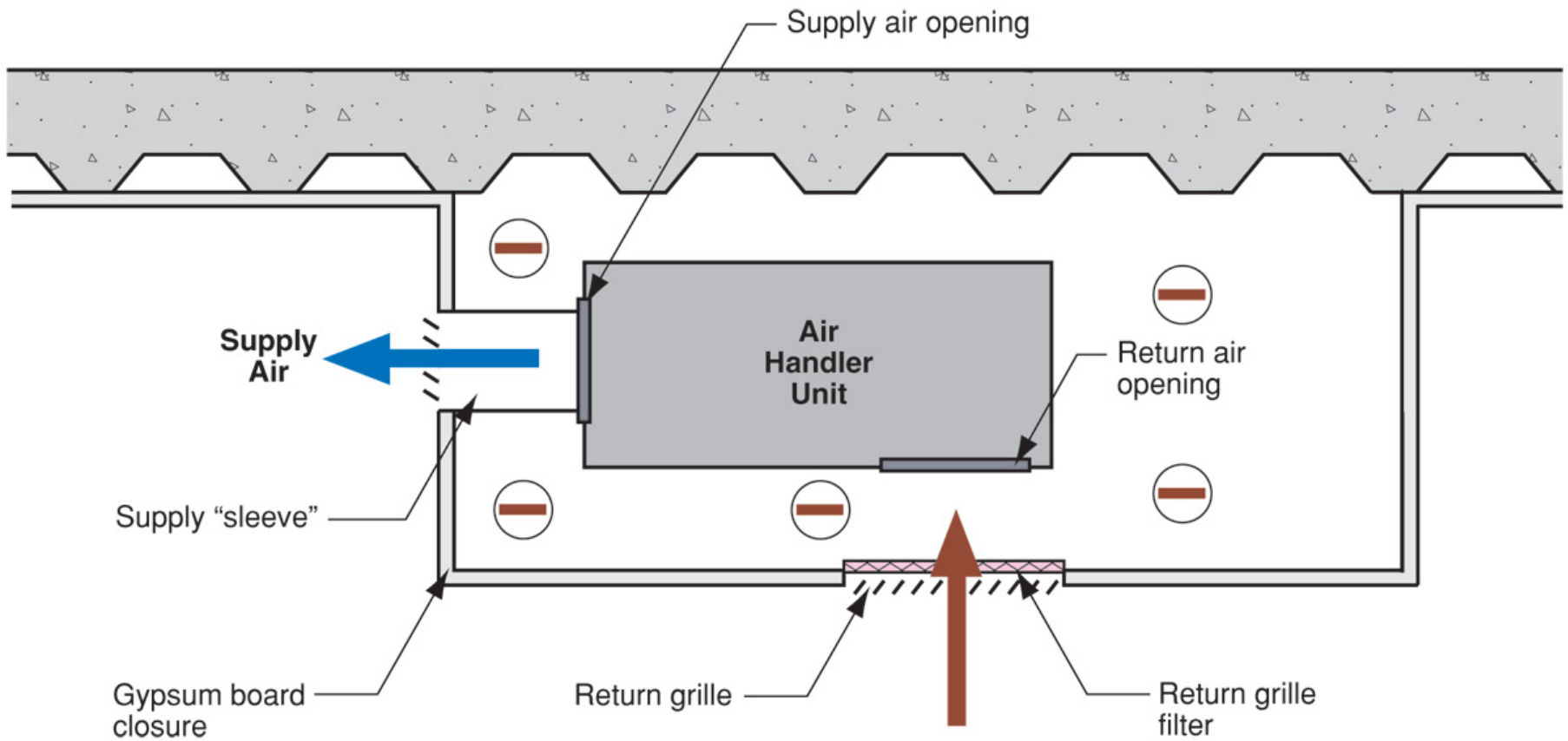

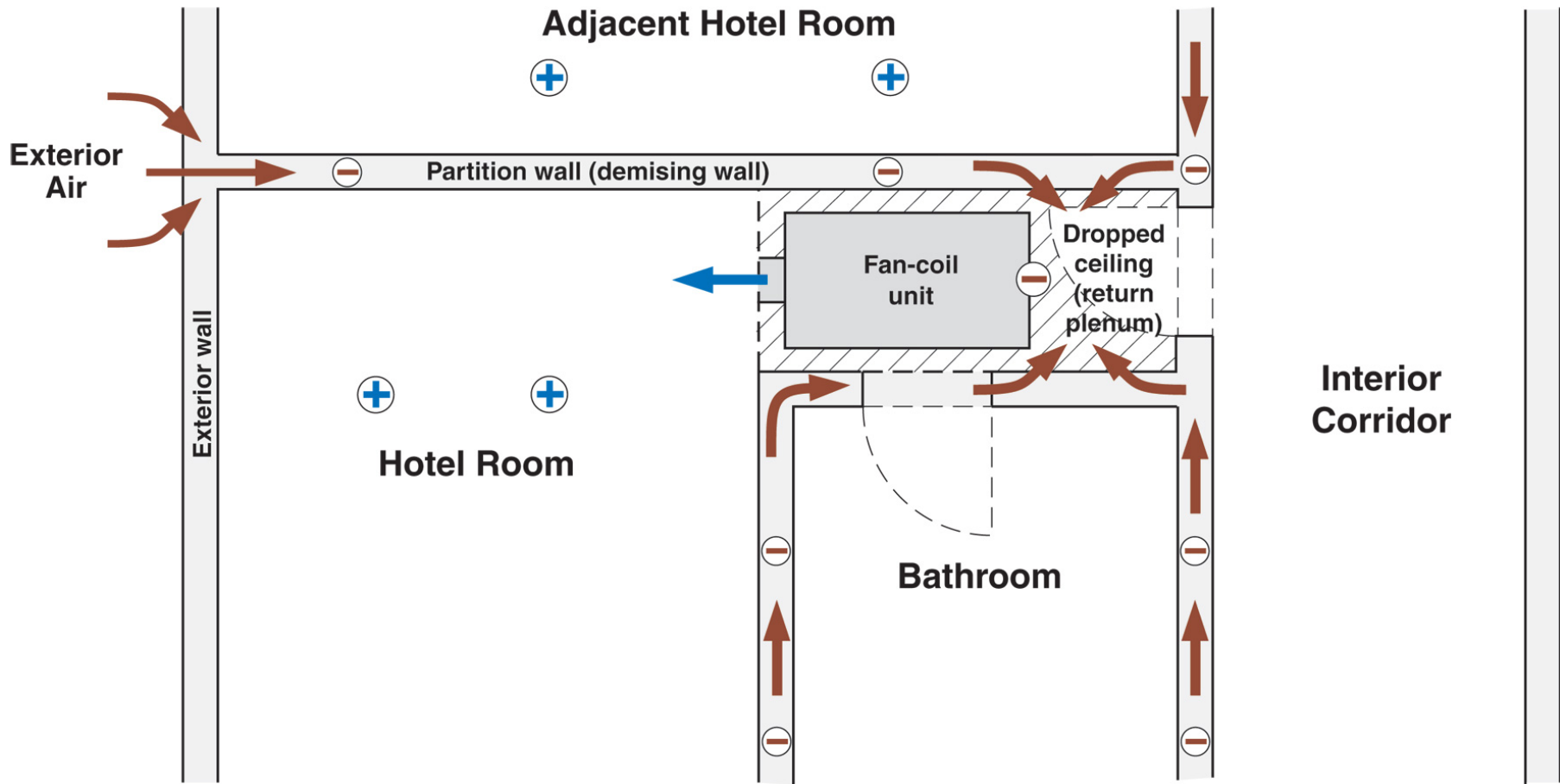

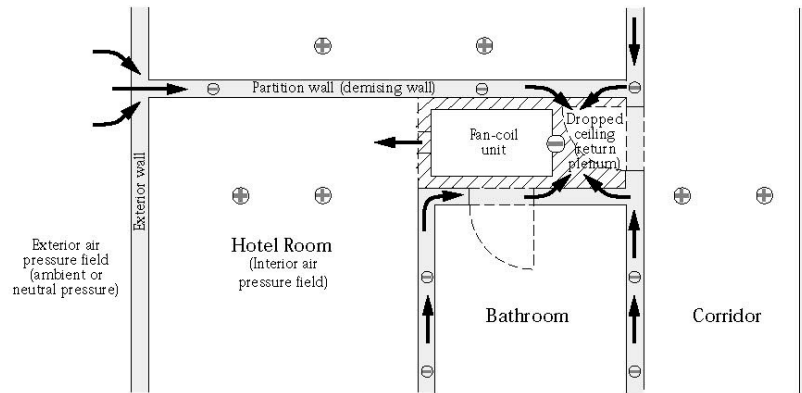

Figure 3.10  
**Pressure Field Due to Fan-Coil Unit**  
**Plan View**

- Room is at positive air pressure relative to exterior-driven air from corridor and air supplied to room from fan-coil unit pulling air from exterior through the demising wall
- Fan-coil unit depressurizes dropped ceiling assembly due to return plenum design
- Demising wall cavity pulled negative due to connection to dropped ceiling return plenum

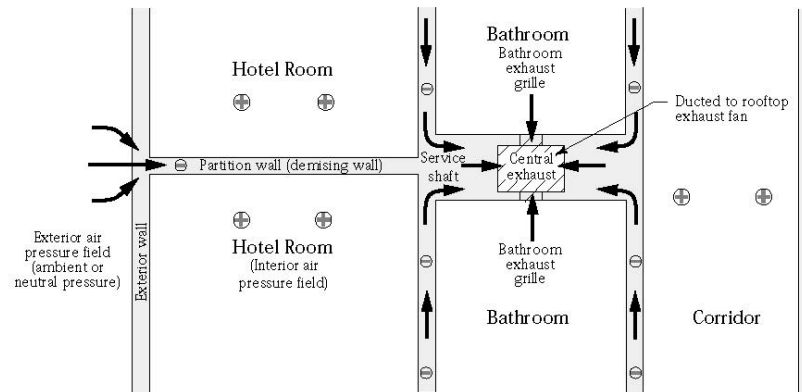

Figure 3.11  
**Pressure Field Due to Central Exhaust**  
**Plan View**

- Leakage of central exhaust duct pulls air out of service shaft depressurizing shaft and demising walls











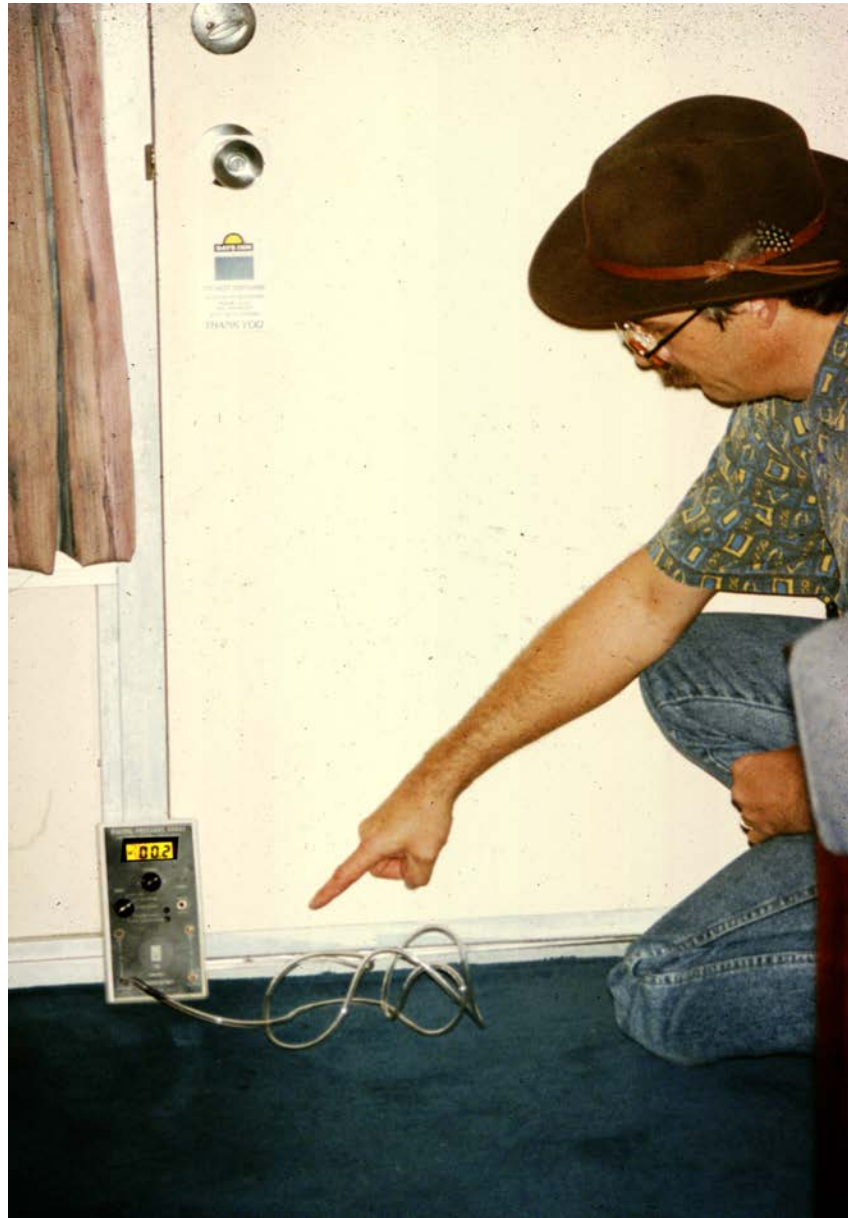















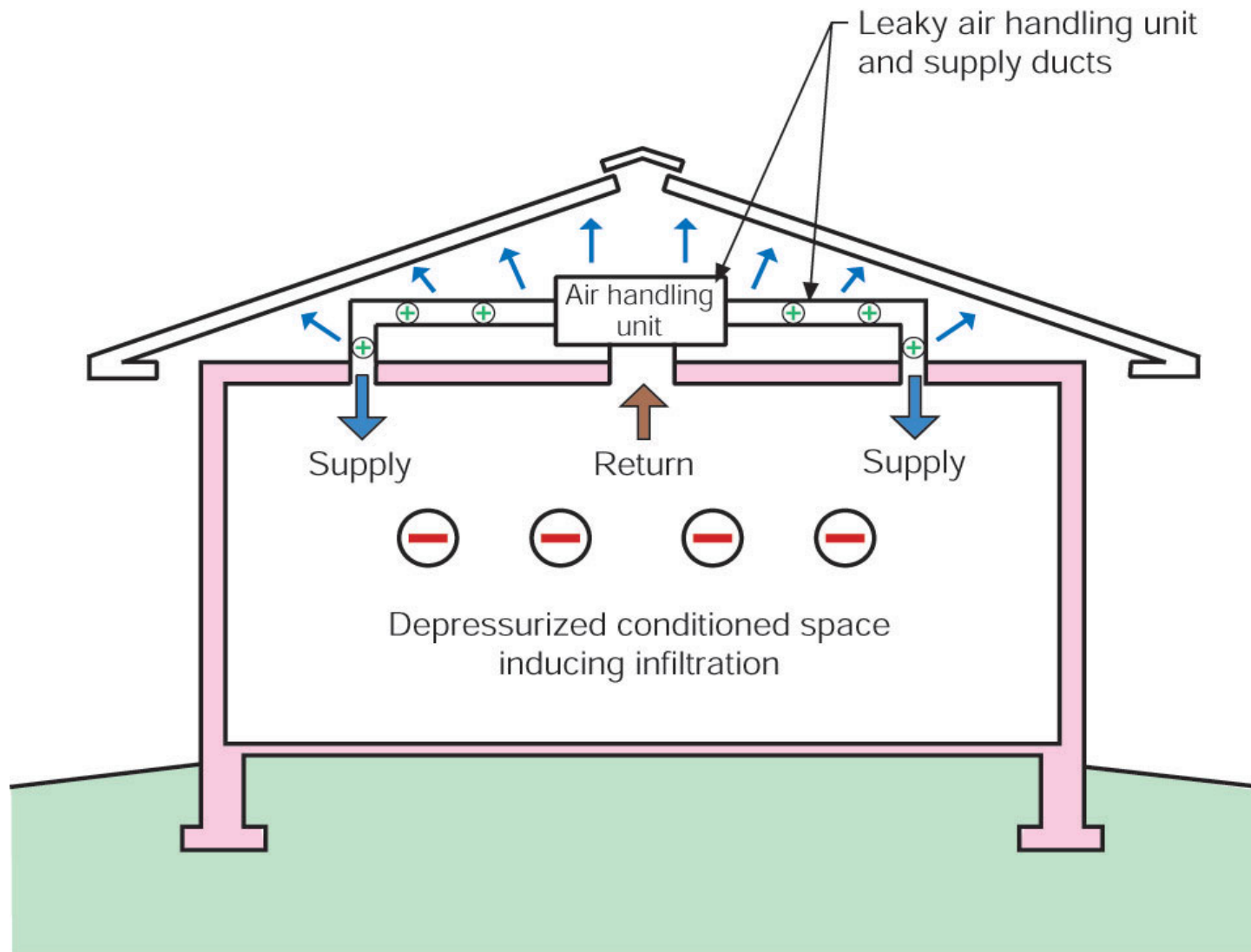

Note: Colored shading depicts the building's thermal barrier and pressure boundary. The thermal barrier and pressure boundary enclose the conditioned space.

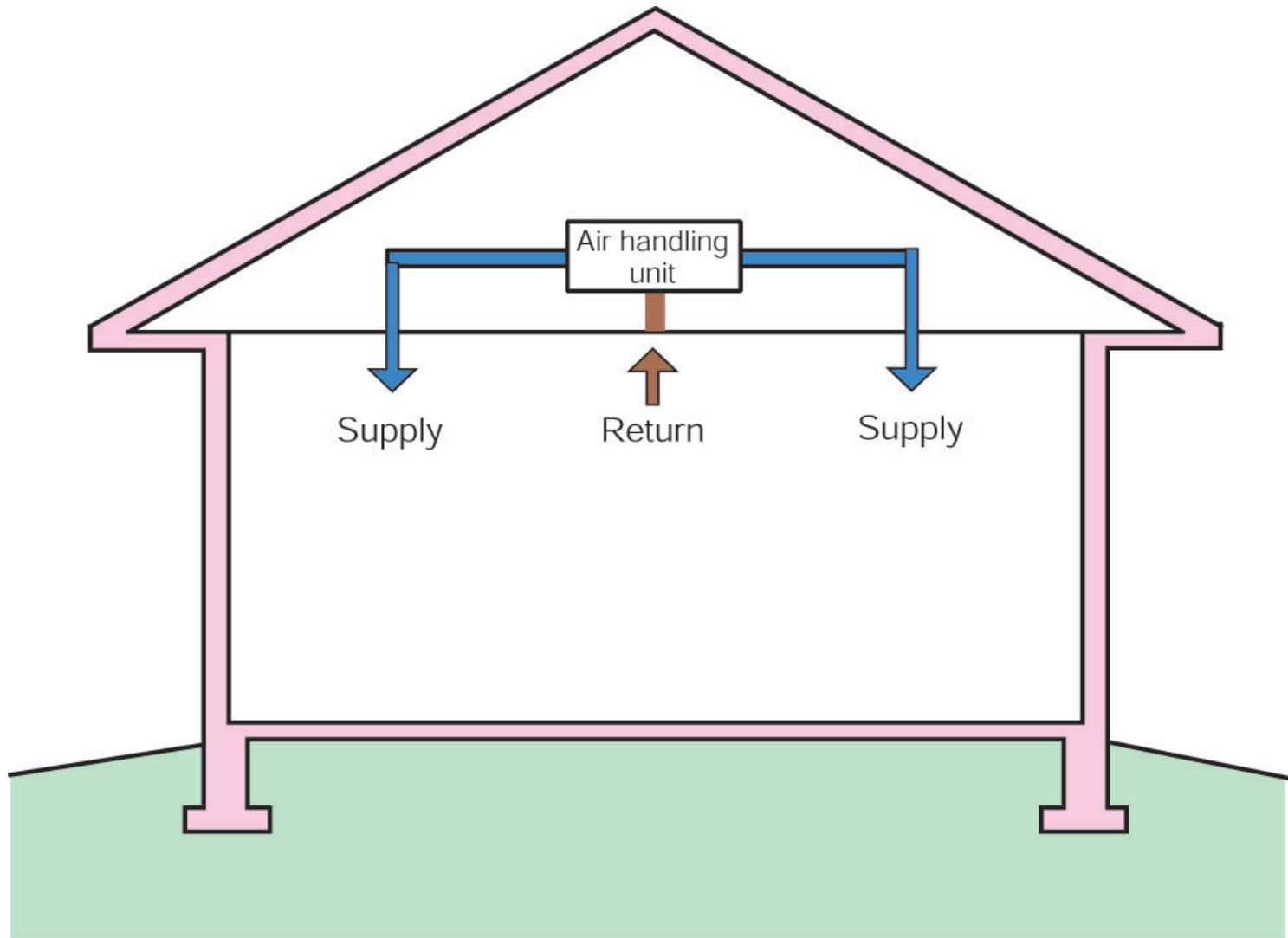

Note: Colored shading depicts the building's thermal barrier and pressure boundary. The thermal barrier and pressure boundary enclose the conditioned space.









